

# QUATTRO 2.0 SLIM K AW

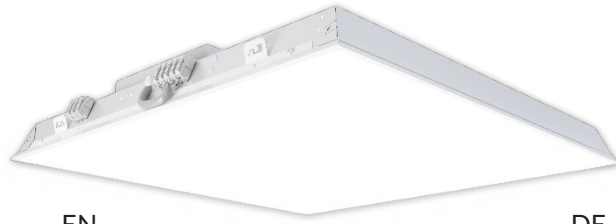

PL

QUATTRO 2.0 SLIM K AW to uniwersalna oprawa kasetonowa. Wyposażona została w moduł zasilania awaryjnego (zasilanie z wbudowanego akumulatora). Do wyboru dwa tryby pracy pozwalające dobrać odpowiednią wartość natężenia światła. Czas pracy oprawy w trybie awaryjnym do 6 godzin. Wysoka skuteczność świetlna dochodząca do 150 lm/W. Oprawa współpracuje z systemem sterowania DALI. Czujnik ruchu na zamówienie.

EN

QUATTRO 2.0 SLIM K AW is a universal cassette luminaire. The luminaire is equipped with an emergency power supply module (power supply from the built-in battery). There are two operating modes to choose the right light intensity value. Luminaire working time in safe mode up to 6 hours. High luminous efficiency up to 150lm/W. The luminaire cooperates with the DALI control system. Custom motion sensor.

DE

QUATTRO 2.0 SLIM K AW ist eine universelle Kassettenleuchte. Die Leuchte ist mit einem Notstromversorgungsmodul (Stromversorgung aus der eingebauten Batterie) ausgestattet. Es gibt zwei Betriebsmodi, um den richtigen Lichtintensitätswert zu wählen. Leuchten-Arbeitszeit im abgesicherten Modus bis zu 6 Stunden. Hohe Lichtausbeute bis 150 lm/W. Die Leuchte arbeitet mit der DALI-Steuerung zusammen. Benutzerdefinierter Bewegungssensor.

## OPCJE DO WYBORU / OPTIONS / OPTIONSWAHL MÖGLICH:



P D  
mP



Tc 4000 K  
inna/different/andere\*\*



biaty/white/weiß

mP – klosz mikropryzmatyczny/ micro-prism cover / mikroprismatische Abdeckung, P – klosz pryzmatyczny / prism cover / prismatische Abdeckung, D – klosz dyfuzyjny / diffusion cover / diffuse Abdeckung  
\*\*Opcje dostępne na zamówienie po konsultacji z działem handlowym. / Options available on request, following consultation with the sales department. / Andere Optionen auf Bestellung nach der Beratung mit der Handelsabteilung erhältlich.

PL

### PARAMETRY TECHNICZNE

Sposób montażu: w sufitach kasetonowych  
Obudowa: blacha stalowa malowana proszkowo  
LED: 3 elipsa MacAdama (SDCM 3)  
Napięcie zasilania: 220-240 V / 50 Hz  
Współczynnik mocy (PF): 0,99  
Poziom zakłóceń harmoniczných THD < 5%  
Klasa ochrony: I  
Wskaźnik oddawania barw CRI (Ra): 80  
Stopień ochrony: IK07  
Stopień szczelności oprawy: IP40  
Stopień szczelności przyłącza: IP20  
Temperatura otoczenia: od 0°C do +35°C  
Wilgotność otoczenia: 20-80%  
Trwałość (L70B10): 100 000 h  
(L80B10): 50 000 h

Parametry pracy oprawy w trybie awaryjnym:  
- 5W (3,5W LED) / 490lm / 140lm/W / 4000K (CRI80) / czas pracy: 3h  
- 2,5W (1,8W LED) / 265lm / 147lm/W / 4000K (CRI80) / czas pracy: 6h  
Akumulator: LiFePO4 3000mAh / 6,4V

**ZASTOSOWANIE:** biura, sale konferencyjne, hotele, restauracje, pomieszczenia mieszkalne, obiekty użyteczności publicznej, korytarze, łazienki

EN

### TECHNICAL PARAMETERS

Mounting: in coffered ceilings  
Body: sheet steel powder-coated  
LED: MacAdam 3 ellipse (SDCM 3)  
Power Supply: 220-240 V / 50 Hz  
Power factor (PF): 0,99  
Harmonic distortion THD < 5%  
Protection class: I  
Color rendering index CRI (Ra): 80  
Protection marking: IK07  
The degree of tightness of the luminaire: IP40  
Protection marking of connection: IP20  
Ambient temperature: from 0°C to +35°C  
Ambient humidity: 20-80%  
Lifetime (L70B10): 100 000 h  
(L80B10): 50 000 h

Parameters of luminaire operation in emergency mode:  
- 5W (3,5W LED) / 490lm / 140lm/W / 4000K (CRI80) / czas pracy: 3h  
- 2,5W (1,8W LED) / 265lm / 147lm/W / 4000K (CRI80) / czas pracy: 6h  
Battery: LiFePO4 3000mAh / 6,4V

**APPLICATION:** offices, conference rooms, hotels, restaurants, residential premises, public utility buildings, corridors, bathrooms

DE

### TECHNISCHE DATEN

Montageart: in Rasterdecken  
Gehäuse: pulverlackiert Stahlblech  
LED: MacAdam 3-Ellipse (SDCM 3)  
Speisespannung: 220-240 V / 50 Hz  
Leistungsfaktor (PF): 0,99  
Harmonische Verzerrung THD < 5%  
Schutzklasse: I  
Farbwiedergabe Faktor CRI (Ra): 80  
Schutzklasse: IK07  
Der Dichtheitsgrad der Leuchte IP40  
Schutzklasse Anschluss: IP20  
Umgebungstemperatur: von 0°C bis +35°C  
Umgebungsluftfeuchtigkeit: 20-80%  
Lebensdauer (L70B10): 100 000 h  
(L80B10): 50 000 h

Parameter des Leuchtenbetriebs im Notbetrieb:  
- 5W (3,5W LED) / 490lm / 140lm/W / 4000K (CRI80) / czas pracy: 3h  
- 2,5W (1,8W LED) / 265lm / 147lm/W / 4000K (CRI80) / czas pracy: 6h  
Akumulator: LiFePO4 3000mAh / 6,4V

**EINSATZBEREICH:** Büros, Konferenzräume, Hotels, Restaurants, Wohnbereiche, öffentliche Gebäude, Korridore, Badezimmer

Deklarowana trwałość dotyczy opraw pracujących w temperaturze otoczenia +25°C przy zapewnionych optymalnych warunkach wentylacji. / The declared lifetime applies to fixtures operating at an ambient temperature of +25°C with ensured optimal ventilation conditions. / Die erklärte Lebensdauer bezieht sich auf Leuchten, die bei einer Raumtemperatur von +25°C und optimalen Lüftungsbedingungen arbeiten.  
\* Spełnienie warunku UGR<19 w sensie normy PN-EN 12464-1:2012 jest wymagane dla konkretnego projektu oświetleniowego i zależy od aktualnych warunków oświetleniowych / Compliance with UGR <19 in the sense of PN-EN 12464-1: 2012 is required for a specific lighting project and depends on current lighting conditions / Die Einhaltung von UGR <19 im Sinne von PN-EN 12464-1: 2012 ist für ein bestimmtes Beleuchtungsprojekt erforderlich und hängt von den aktuellen Lichtverhältnissen ab



EAN	CODE	[W]	[K]	[°]	[lm]	[lm/W]	
-----	------	-----	-----	-----	------	--------	--

Typ: KASETONOWY (K) 600x600, IP40 / Type: CASSETTE (K) 600x600, IP40 / Art: CASSETTE (K) 600x600, IP40

5904441707991	175001D830-0P01-0103	30	3000	P	90	3700	123	DALI
5904441708004	175001D830-0D01-0103	30	3000	D	115	3500	117	DALI
5904441708011	175001D830-mP01-0103	30	3000	mP	100	3500	117	DALI
5904441708028	175001D830-0P01-0104	35	3000	P	90	4200	120	DALI
5904441708035	175001D830-0D01-0104	35	3000	D	115	4000	114	DALI
5904441708042	175001D830-mP01-0104	35	3000	mP	100	4000	114	DALI
5904441708059	175001D830-0P01-0105	40	3000	P	90	4800	120	DALI
5904441708066	175001D830-0D01-0105	40	3000	D	115	4500	113	DALI
5904441708073	175001D830-mP01-0105	40	3000	mP	100	4500	113	DALI
5904441708080	175001D830-0P01-0107	50	3000	P	90	5900	118	DALI
5904441708097	175001D830-0D01-0107	50	3000	D	115	5500	110	DALI
5904441708103	175001D830-mP01-0107	50	3000	mP	100	5500	110	DALI
5904441708110	175001D830-0P01-0109	60	3000	P	90	6800	113	DALI
5904441708127	175001D830-0D01-0109	60	3000	D	115	6400	107	DALI
5904441708134	175001D830-mP01-0109	60	3000	mP	100	6400	107	DALI
5904441708141	175001D830-0P01-0111	70	3000	P	90	7700	110	DALI
5904441708158	175001D830-0D01-0111	70	3000	D	115	7300	104	DALI
5904441708165	175001D830-mP01-0111	70	3000	mP	100	7300	104	DALI
5904441708172	175001D830-0P01-0113	85	3000	P	90	8800	103	DALI
5904441708189	175001D830-0D01-0113	85	3000	D	115	8300	98	DALI
5904441708196	175001D830-mP01-0113	85	3000	mP	100	8300	98	DALI
5904441708202	175001D840-0P01-0103	30	4000	P	90	4100	137	DALI
5904441708219	175001D840-0D01-0103	30	4000	D	115	3900	130	DALI
5904441708226	175001D840-mP01-0103	30	4000	mP	100	3900	130	DALI
5904441708233	175001D840-0P01-0104	35	4000	P	90	4700	134	DALI
5904441708240	175001D840-0D01-0104	35	4000	D	115	4500	128	DALI
5904441708257	175001D840-mP01-0104	35	4000	mP	100	4500	128	DALI
5904441708264	175001D840-0P01-0105	40	4000	P	90	5300	133	DALI
5904441708271	175001D840-0D01-0105	40	4000	D	115	5000	125	DALI
5904441708288	175001D840-mP01-0105	40	4000	mP	100	5000	125	DALI
5904441708295	175001D840-0P01-0107	50	4000	P	90	6500	130	DALI
5904441708301	175001D840-0D01-0107	50	4000	D	115	6100	122	DALI
5904441708318	175001D840-mP01-0107	50	4000	mP	100	6100	122	DALI
5904441708325	175001D840-0P01-0109	60	4000	P	90	7500	125	DALI
5904441708332	175001D840-0D01-0109	60	4000	D	115	7100	118	DALI
5904441708349	175001D840-mP01-0109	60	4000	mP	100	7100	118	DALI
5904441708356	175001D840-0P01-0111	70	4000	P	90	8500	121	DALI
5904441708363	175001D840-0D01-0111	70	4000	D	115	8100	116	DALI
5904441708370	175001D840-mP01-0111	70	4000	mP	100	8100	116	DALI
5904441708387	175001D840-0P01-0113	85	4000	P	90	9800	115	DALI
5904441708394	175001D840-0D01-0113	85	4000	D	115	9300	109	DALI
5904441708400	175001D840-mP01-0113	85	4000	mP	100	9300	109	DALI

Całkowity strumień świetlny oprawy zmierzony za kloszem przy temp. otoczenia +25oC. Tolerancja strumienia świetlnego +/- 10%. Pomiary fotometryczne zostały wykonane zgodnie z wymaganiami normy PN-EN13032. / The total luminous flux of the luminaire measured diffuser +25oC. Luminous flux tolerance +/- 10%. Photometric measurement were examined in accordance with the PN-EN13032 system. / Gesamtlichtstrom der Leuchte, gemessen hinter der Abdeckung +25oC. Lichtstrom-Toleranz +/- 10%. Photometrische Messungen wurden nach PN-EN13032 Norm geprüft.

FOTOMETRIA / PHOTOMETRY / PHOTOMETRIE:

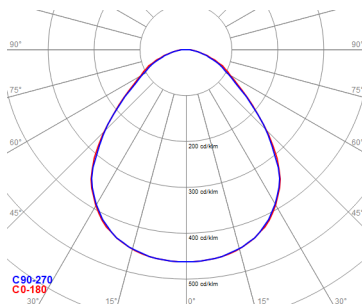

QUATTRO 2.0 SLIM K AW-P\_40W\_4000K

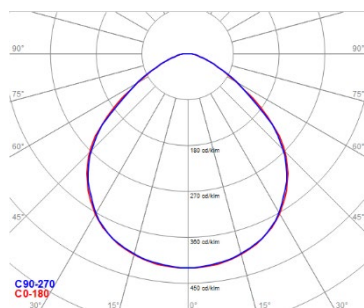

QUATTRO 2.0 SLIM K AW-mP\_40W\_4000K

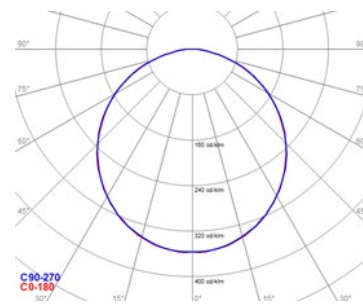

QUATTRO 2.0 SLIM K AW-D\_40W\_4000K

WYMIARY / DIMENSIONS / MASSE:



L [mm]    W [mm]    H [mm]    [kg]

Typ: KASETONOWY (K), IP40 / Type: CASSETTE (K), IP40 / Art: CASSETTE (K), IP40



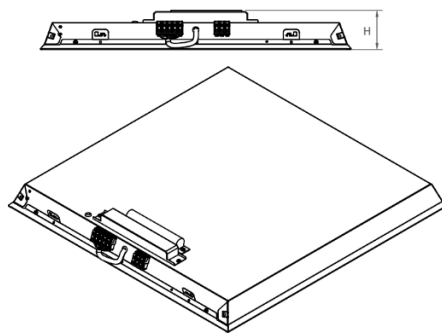
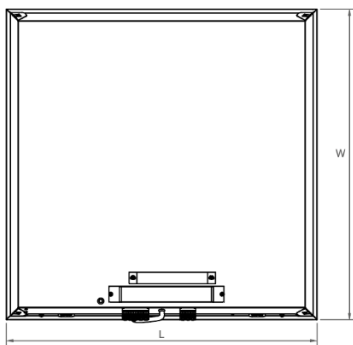

















600 x 600    594    594    75    3,1



W związku z ciągłym rozwojem produktów zastrzegamy sobie prawo do wprowadzania zmian konstrukcyjnych w oprawkach oraz aktualizowania parametrów.  
 Due to continuous product development, we reserve the right to introduce structural changes in the fixtures and to update their parameters. Aufgrund der ständigen  
 Produktentwicklung behalten wir uns das Recht vor, technische Änderungen u Aktualisierung von Parametern an Leuchten vorzunehmen.

Data aktualizacji / Revision Date / Datum der letzten Aktualisierung: 10.07.2023

LEGENDA / LEGEND / LEGENDE:

	Deklaracja zgodności Declaration of conformity EG-Konformitätserklärung		Klasa ochronności I Protection class I Schutzklasse I		Napięcie zasilania Power supply Speisespannung
	Źródło światła LED LED source LED Quelle		Technologia stałego strumienia świetlnego Constant luminous flux technology Konstante Lichtstromtechnologie		Dyrektywa RoHS The RoHS Directive RoHS Richtlinie
	Wymiary montażowe Mounting dimensions Montagem Maße		Stopień szczelności IP IP protection marking Schutzklasse IP		Wskaźnik oślnienia przykrego Glare indicator Blendungsanzeige
	Kod produktu Code Artikelnummer		Rodzaj klosza Cover Abdeckung		Moc oprawy Luminaire power Leistung der Leuchte
	Kąt rozsyłu światłości Light distribution angle Winkel der Lichtverteilung		Wymiary Dimensions Masse		Temperatura barwowa Color temperature Farbtemperatur
	Strumień świetlny Luminous flux Lichtstrom		Skuteczność świetlna Luminous efficiency Lichtausbeute der Leuchte		System sterowania DALI DALI control system Steuersystem DALI
	Kolor oprawy Luminaire color Leuchte Farbe		Waga Weight Gewicht		Nazwa produktu Product name Produktname