

# JBC

[www.jbctools.com](http://www.jbctools.com)

## INSTRUCTION MANUAL



# Compact Solder Feed Station

Ref. CA-QF

# Packing List

The following items are included:



**CA Control Unit** ..... 1 unit  
 Ref. CA-1F (120V)  
 CA-2F (230V)  
 CA-9F (100V)



**Solder Feed Iron** ..... 1 unit \*  
 Ref. AP250-A  
*Supplied with  
 guide tube for  
 wire Ø 0.8 - 1mm*



**Feeder Nozzle Ø 1.5mm** ..... 1 unit  
 Ref. 0016351



**Power Cord** ..... 1 unit  
 Ref. 00023715 (120V)  
 00023714 (230V)  
 00025092 (100V)



**Brass Wool** ..... 1 unit  
 Ref. CL6210



**Sponge** ..... 1 unit  
 Ref. S0354



**Solder reel** ..... 1 unit  
 Ref. 0002801



**Allen key Ø 2.5mm** ..... 1 unit  
 Ref. 0023792



**Manual** ..... 1 unit  
 Ref. 0026066

## Features and Connections



**Solder Feed Iron**  
Ref. AP250-A

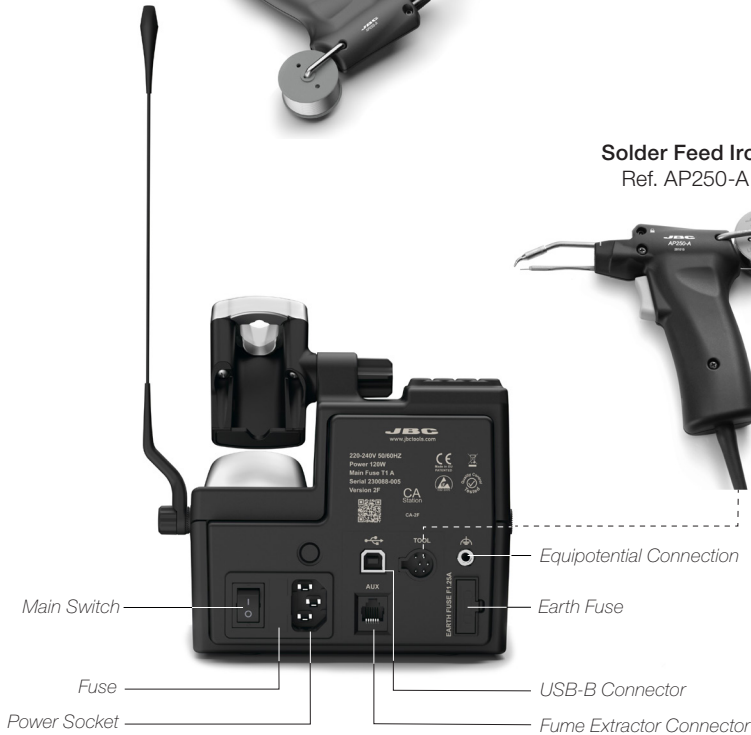

## Adjustable Stand

Adjust the tool stand to suit your work position.

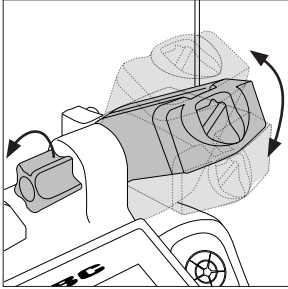

## Cable Collector (Ref. CC1001)

Place the cable on the collector so that the working area is free of cable.

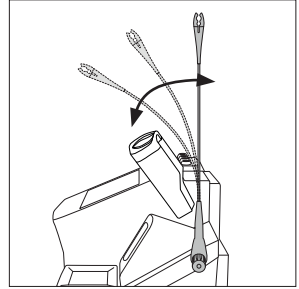
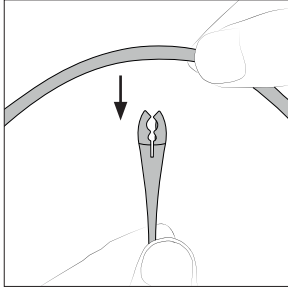

## Tip Cleaner

Select the option to suit your needs and improve the thermal transfer of the tip.

### Splashguard

Ref. 0017576

*When using the brass wool, it prevents splashing of solder particles.*

### Antisplash Membrane

Ref. 0017574

*Prevents splashing and keeps the work area clean.*

### Brass Wool

Ref. CL6210

*Very effective cleaning method. Leaves a small layer of solder on the tip preventing oxidation between cleaning and reflowing.*

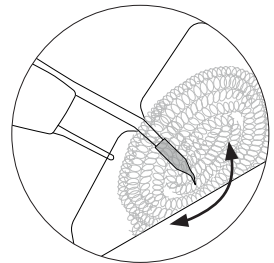
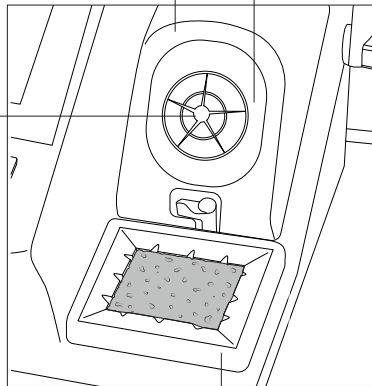

*If the tip is very dirty, JBC recommends first cleaning it with the wiper to remove excess solder.*

### Wiper

Ref. CL0160

*A temperature resistant receptacle for removing excess solder by gently tapping or wiping.*

## Removing the Splashguard

1. Unlock the splashguard.

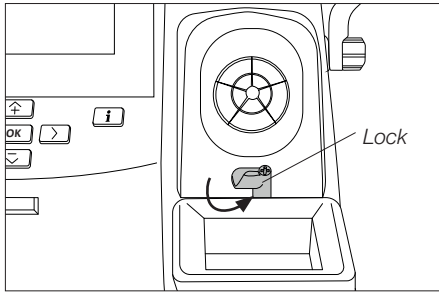

2. Lift off.

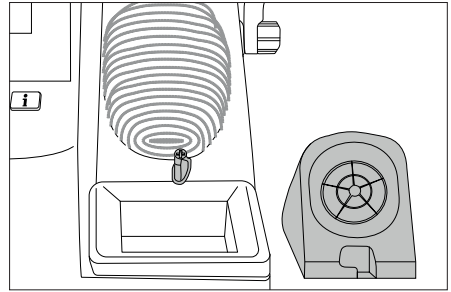

More cleaning options (not supplied):

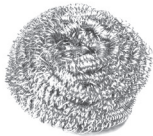

**Inox Wool**  
Ref. CL6205  
Stronger cleaning method than brass wool.

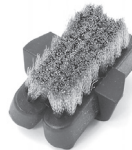

**Metal Brush**  
Ref. CL6220  
When used carefully, it provides a more thorough cleaning.

## Wiper

Ref. CL0160

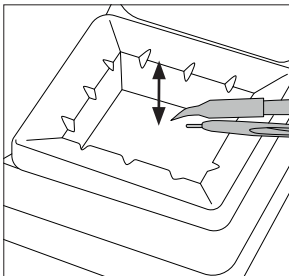

## Tapping:

Tap gently to remove excess solder.

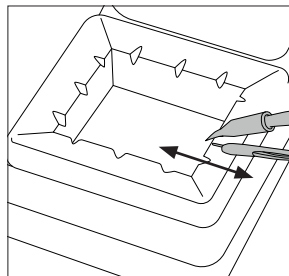

## Wiping:

Use the slots to remove remaining particles.

## Sponge

Ref. S0354

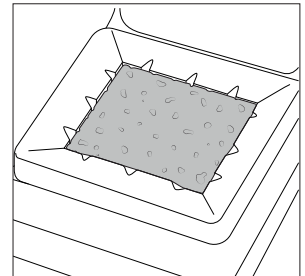

The softest cleaning method. Keep the sponge damp with distilled water when working to avoid tip wear.

# Changing Cartridge

⚠ To change a cartridge safely, unplug the tool or turn off the station before following these guidelines.

## 1. Removing

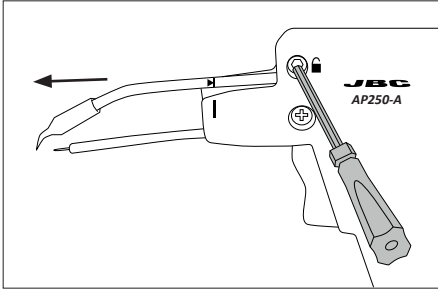

Loosen the screw and remove the cartridge.  
⚠ Use a flat pliers if still hot.

## 2. Inserting

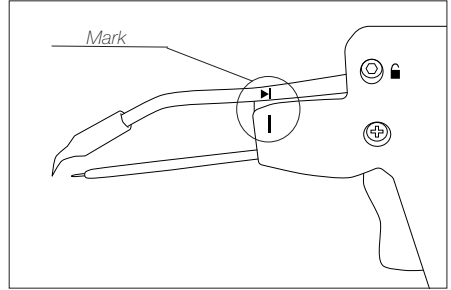

**Important:** Insert the cartridge as far as the mark for a correct connection.

## 3. Aligning

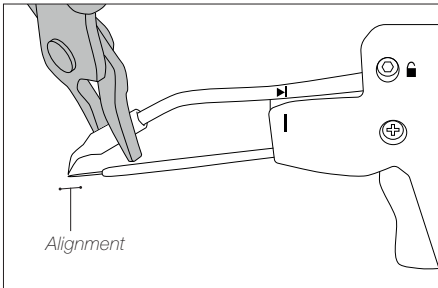

Align the cartridge tip with the feeder nozzle. Use a flat pliers for a correct tip alignment.

## 4. Fixing

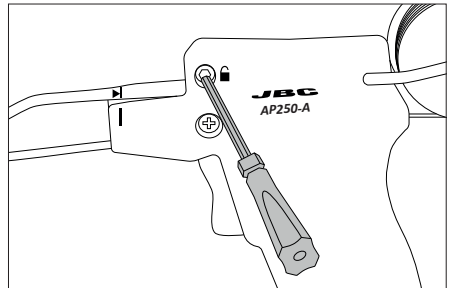

**Important:** Tighten the screw again. This is necessary for the tool to function. Being careful not to over-tighten.

## Compatible Cartridges

The CA stations work with C250 cartridges and AP250 Solder Feed Iron.  
Find the model that best suits your soldering needs in [www.jbctools.com](http://www.jbctools.com)

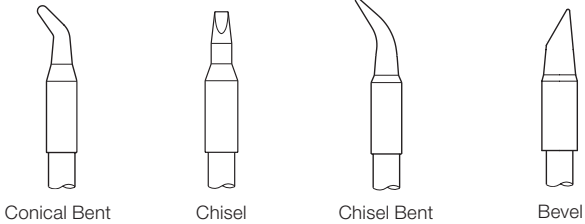

## Replacing Solder Wire

### 1. Removing

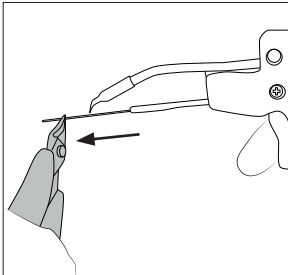

Pull out the remaining solder wire from the feed tube. Use a pliers if necessary.

### 2. Replacing

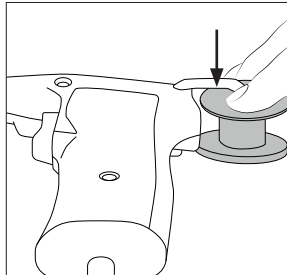

Pull off the empty reel and fit the new one.

### 3. Inserting

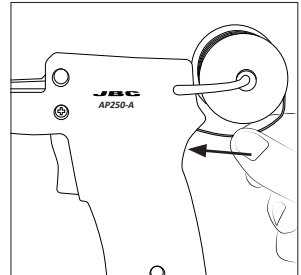

Insert the solder wire while pushing the trigger repeatedly until the solder wire appears at the nozzle tip. Always use 0.8 - 1.0 mm diameter solder wire\*.

\* Use 1.0 - 1.5 mm diameter solder wire with the 0019211 Feeder Nozzle.

# Changing Feeder Nozzle

⚠ Unplug the tool or turn off the station before following these guidelines

1. Unscrew the rear screw, than remove the reel and the solder wire from the nozzle.

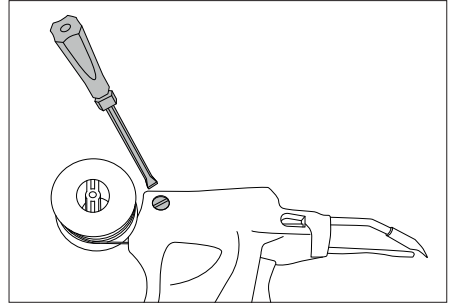

2. Unscrew the two screws on the other side of the solder feeder.

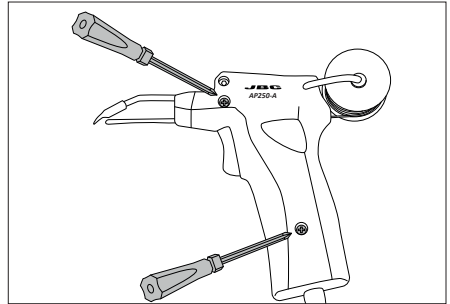

3. Remove the screws and lift off the cover.

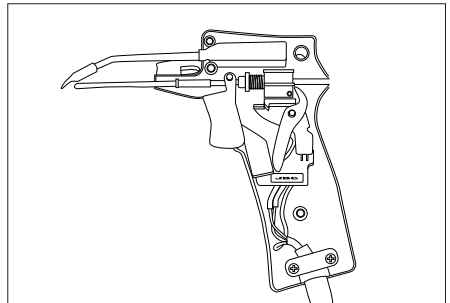



4. Take out the feeder nozzle and replace it with the new one while holding the three components, identified in the picture, in place. Reassemble the cover and tighten the three screws.

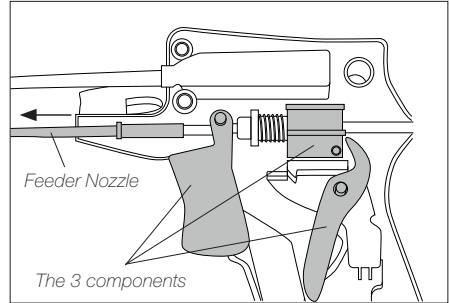

## Regulating Feeder Nozzle

1. Depending on the cartridge used and the component to be soldered, you can vary the feeder nozzle length up to 10mm.

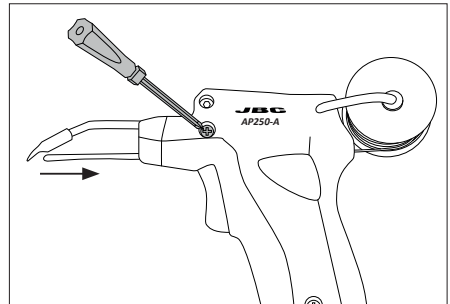

2. Adjust the feeder nozzle length and tighten the screw.

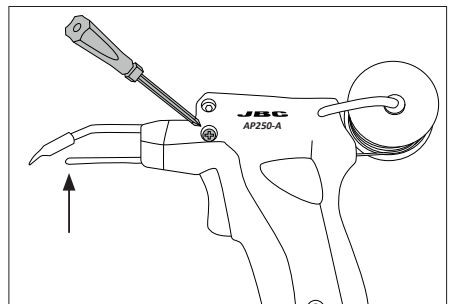

# Operation

## The JBC Most Efficient Soldering System

This revolutionary technology is able to recover tip temperature extremely quickly. This allows the user to work at a lower temperature. As a result, tip life increases by 5.

### 1. Work

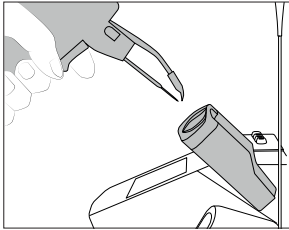

When the tool is lifted from the stand the tip will heat up to the selected temperature.

### 2. Sleep

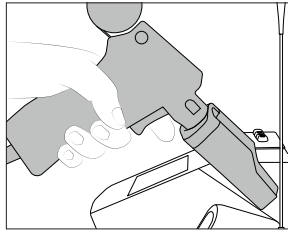

When the tool is in the stand, the temperature falls to the preset sleep temperature.

### 3. Hibernation

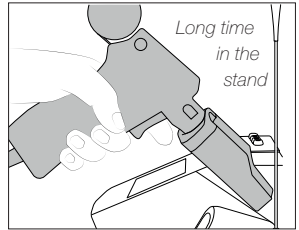

After longer periods of inactivity, the power is cut off and the tool cools down to room temperature.

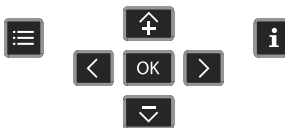
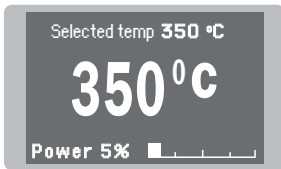

- Change temperature (from 90 to 450°C)
  - ^ v Steps ± 5
  - < > Steps ± 50

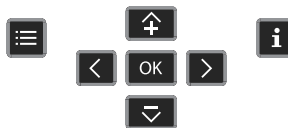

- Through menu settings:
  - Change Sleep temperature
  - Set Sleep delay (from 0 to 9 min or no Sleep)

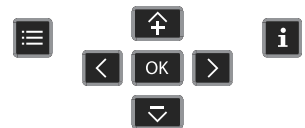
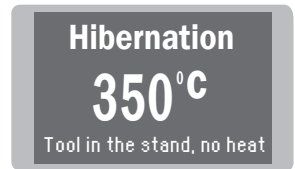

- Through menu settings:
  - Change Hibernation delay (from 0 to 35 min)

- Through menu settings:
  - Select temperature levels
  - Fix one temperature

## Control Process

### Work Screen

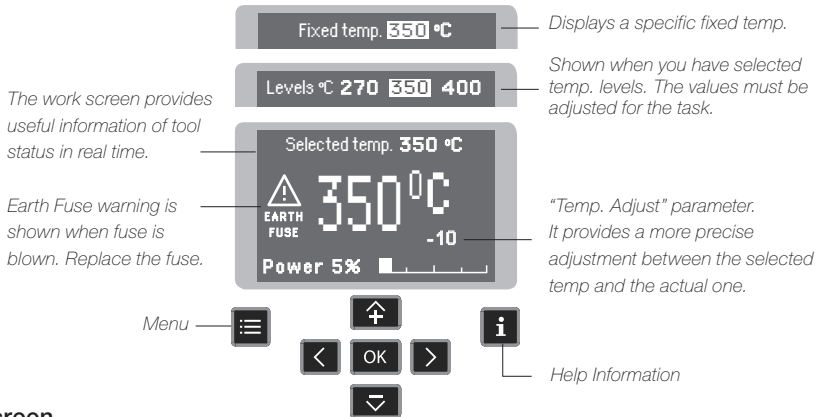

### Menu Screen

Default PIN: 0105

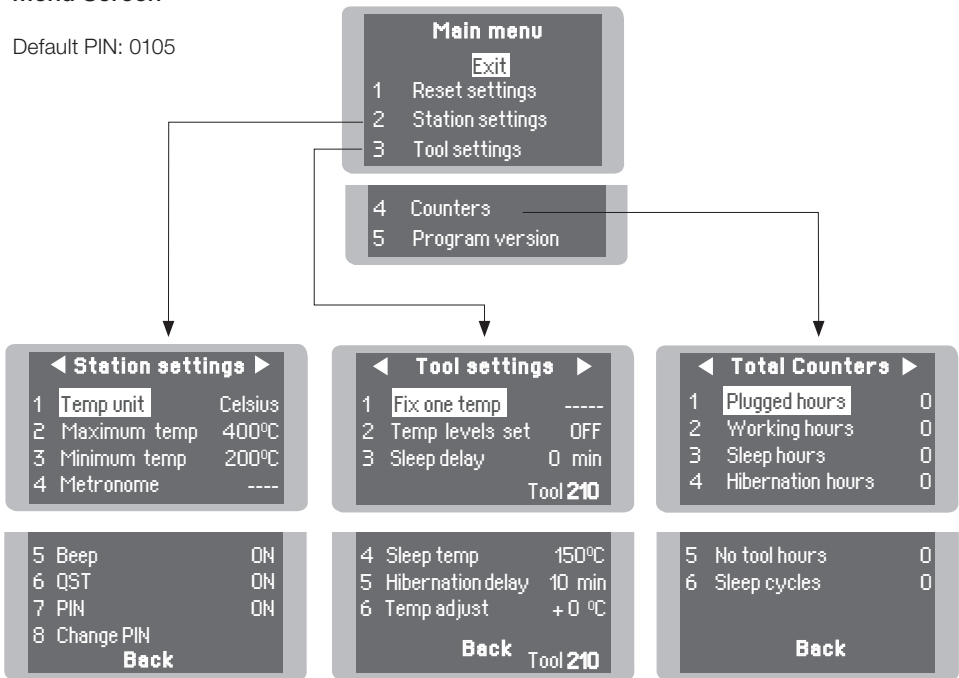

### Troubleshooting

Station troubleshooting available on the product page at [www.jbctools.com](http://www.jbctools.com)

# Parameters

Be careful when using these parameters as they may reduce the tip life if not used properly. Please follow the recommended guidelines:



## Station Settings

Parameter Description	Recommendations	Warnings
<b>Temperature Unit</b> Celsius (°C) or Fahrenheit (°F)	N/a	
<b>Maximum Temperature</b> Set the maximum temperature to work with. Max. temp by default is 400°C (750°F). This is considered high enough to work with most lead-free applications.	The station temperature range is 90-450°C (190-840°F). Change the temperature limits when working with less common applications such as low / high melting point soldering (HMP) or plastics (e. g. riveting).	 In most cases, working with temperatures over 400°C (750°F) can damage the PCB and its components. Even in short time periods of tip contact with the soldering joint, the flux may not work properly and could seriously reduce tip life. If the solder joint requires more power (e.g. multilayered or high dissipation boards), JBC strongly recommends using other aids like preheaters.
<b>Minimum Temperature</b> Set the minimum temperature to work with. Min. temp. by default is 200°C (392°F). This is considered to be a proper starting point for leaded applications.		
<b>Metronome</b> This activates a beep sound. Frequencies vary from 1 to 50 seconds.	Useful for setting a work rate in repetitive jobs. The beep lets you know the length of time the tip must be in contact with the soldering joint.	N/a
<b>Beep</b> Enable/disable the beep sound of the keypad.	N/a	N/a
<b>QST</b> Enable/disable QST.	N/a	N/a
<b>Pin</b> Enable/disable pin prompt.	N/a	N/a
<b>Change Pin</b> Change the default security PIN number (0105).	The PIN must be entered every time a parameter is changed.	N/a

## Tool Settings

Parameter	Description	Recommendations	Warnings
<b>Fix One Temperature</b>	Fix a value within the temperature range of the station (90-450°C/190-840°F).	Ideal for soldering more than one component at a specific temperature. The station will reject any attempt to change the temperature.	N/a
<b>Temperature Levels Set</b>	Similar to “Fix one temp” parameter. In this case, the user can set up to 3 values for different power requirements.	This allows a quick change between 3 different temperatures. Set them according to the allowed values for your soldering applications.	N/a
<b>Sleep Delay</b>	Set the time that the tool will remain at the selected temperature when in the stand before entering sleep mode. The tip temperature will then drop to the Sleep temperature.	Because our tools reach the working temperature from the default Sleep mode in only a few seconds, this parameter is preset to 0 min. Once the tool is returned to the stand the temperature will automatically drop to the sleep temperature, extending tip life and avoiding oxidation. Retinning the tip before placing the tool in the stand will protect the tip and extend its life.	 Setting these parameters to higher values will unnecessarily accelerate oxidation and shorten tip life especially when working with temperatures up to 450°C (840°F).
<b>Sleep Temperature</b>	This is the set temperature the tip reaches when returned to the stand.	The sleep temperatures are set to achieve a balance between preventing oxidation and reaching the working temperature in a few seconds.	

## Tool Settings

Parameter Description	Recommendations	Warnings
<p><b>Hibernation Delay</b> Set the time the tool will remain at Sleep temperature before entering the Hibernation mode. At this time, the power supply is cut off and the tip remains at room temperature.</p>	<p>This function completely protects the tip from oxidation during long periods of inactivity while the tool is in the stand. Retinuing the tip before placing the tool in the stand also helps prevent oxidation and extends the life of the tip.</p>	<p> Increasing the default value will accelerate oxidation and shorten the tip life.</p>
<p><b>Temp Adjustment</b> It provides a more precise adjustment between the selected temperature and the actual one.</p>	<p>Set values within <math>\pm 50^{\circ}\text{C}</math> (<math>\pm 90^{\circ}\text{F}</math>) to achieve zero error. JBC strongly recommends the use of TID-A or TIA-A Thermometers to obtain precise readings.</p>	<p> When the user changes the cartridge type, the parameter should be reset to <math>0^{\circ}\text{C}/\text{F}</math> or to the value needed for this cartridge. E.g. If a correction of <math>+20^{\circ}\text{C}</math> (<math>+36^{\circ}\text{F}</math>) is set for a thick cartridge and then the user changes to a thinner one without resetting the temperature adjustment, he would be working at a higher temperature than needed for this thinner cartridge, which does not need any temperature adjustment.</p>

## USB Connector

Download the latest software from our website to update your soldering station.

### JBC Updater

[www.jbctools.com/software.html](http://www.jbctools.com/software.html)

Update the station software via USB connection:

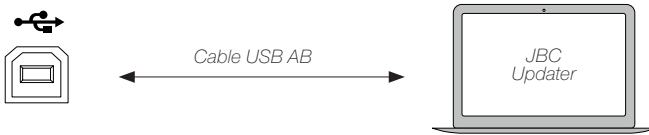

### JBC Manager

[www.jbctools.com/manager.html](http://www.jbctools.com/manager.html)

Manage and monitor as many stations as your PC can handle by using the JBC Manager. You can export data to another PC.

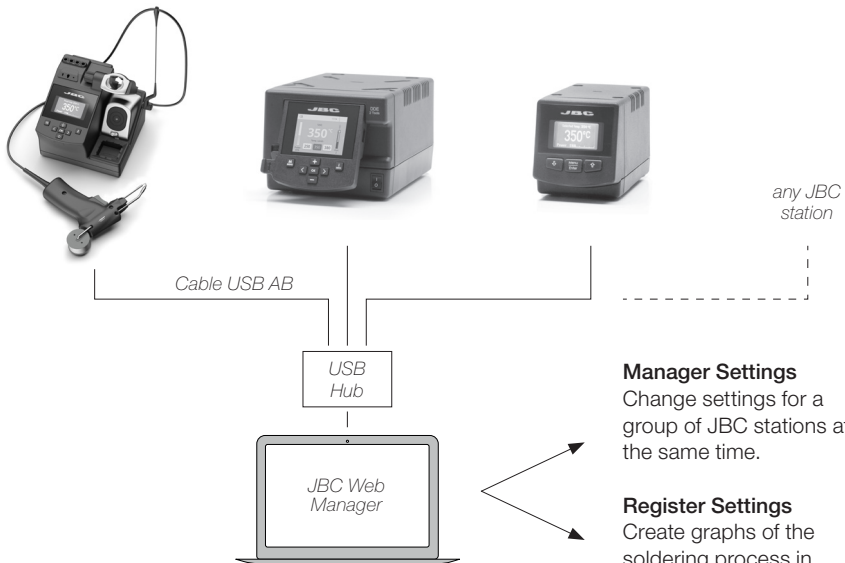

#### Manager Settings

Change settings for a group of JBC stations at the same time.

#### Register Settings

Create graphs of the soldering process in real time showing power and temperature data.

# Maintenance

Before carrying out maintenance, always switch the device off and disconnect it from the mains. Allow the equipment to cool down.

- Clean the station screen with a glass cleaner or a damp cloth.
- Use a damp cloth to clean the casing and the tool. Alcohol can only be used to clean the metal parts.
- Periodically check that the metal parts of the tool and stand are clean so that the station can detect the tool status.
- Maintain tip surface clean and tinned prior to storage in order to avoid tip oxidation. Rusty and dirty surfaces reduce heat transfer to the solder joint.
- Periodically check all cables and tubes.
- Replace any defective or damaged pieces. Only use original JBC spare parts.
- Replace a blown fuse as follows:
  1. Pull off the fuse holder and remove the fuse. If necessary use a tool to lever it off.
  2. Insert the new fuse into the fuse holder and return it to the station.

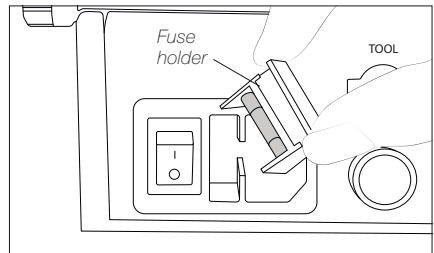
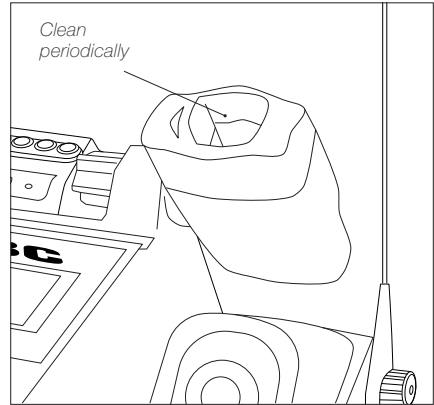

- When this warning appears on the main screen Earthing Fuse must be replaced

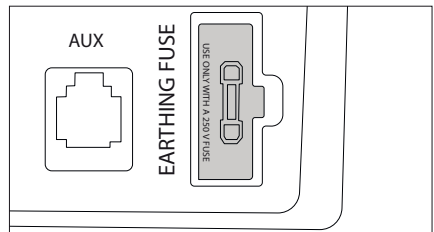

- Repairs should only be performed by a JBC authorized technical service.



## Safety



**It is imperative to follow safety guidelines to prevent electric shock, injury, fire or explosion.**

- Do not use the units for any purpose other than soldering or rework. Incorrect use may cause fire.
- The power cord must be plugged into approved bases. Be sure that it is properly grounded before use. When unplugging it, hold the plug, not the wire.
- Do not work on electrically live parts.
- The tool should be placed in the stand when not in use in order to activate the sleep mode. The soldering tip, the metal part of the tool and the stand may still be hot even when the station is turned off. Handle with care, including when adjusting the stand position.
- Do not leave the appliance unattended when it is on.
- Do not cover the ventilation grills. Heat can cause inflammable products to ignite.
- Avoid flux coming into contact with skin or eyes to prevent irritation.
- Be careful with the fumes produced when soldering.
- Keep your workplace clean and tidy. Wear appropriate protection glasses and gloves when working to avoid personal harm.
- Utmost care must be taken with liquid tin waste which can cause burns.
- This appliance can be used by children over the age of eight and also persons with reduced physical, sensory or mental capabilities or lack of experience provided that they have been given adequate supervision or instruction concerning use of the appliance and understand the hazards involved. Children must not play with the appliance.
- Maintenance must not be carried out by children unless supervised.



## Specifications

**CA-1QF** 120V 50/60Hz. Input fuse: 2A. Output: 23.5V. Control Unit model: **CA-1F**

**CA-2QF** 230V 50/60Hz. Input fuse: 1A. Output: 23.5V. Control Unit model: **CA-2F**

**CA-9QF** 100V 50/60Hz. Input fuse: 2A. Output: 23.5V. Control Unit model: **CA-9F**

- Output Peak Power CA-F: 130 W
- Temperature Range: 90 - 450 °C / 190 - 840 °F
- Idle Temp. Stability (still air):  $\pm 1.5$  °C /  $\pm 3$  °F (Meets and exceed IPC J-STD-001)
- Temp. Accuracy:  $\pm 3\%$  (Using reference cartridge)
- Temp. Adjustment:  $\pm 50$  °C /  $\pm 90$  °F (Through station menu setting)
- Tip to Ground Voltage/Resistance: Meets and exceed  
ANSI/ESD S20.20-2014 IPC J-STD-001F
- Earthing Fuse: F 1.25A
- Connections: USB connector station-PC  
RJ12 connector
- Ambient Operating Temp.: 10 - 50 °C / 50 - 122 °F
- Diameter of Solder Wire: from 0.8 - 1 mm / 0.03 - 0.04 in  
from 1.1 - 1.5 mm / 0.04 - 0.06 in
- Control Unit Dimensions / Weight: 170 x 176 x 145 mm / 2.8 kg  
(L x W x H) 6.7 x 6.9 x 5.7 in / 6.17 lb
- Total Net Weight: 2.91kg / 6.42 lb
- Total Package Dimensions / Weight: 234 x 234 x 258 mm / 3.52 kg  
(L x W x H) 9.2 x 9.2 x 10.2 in / 7.76 lb

Complies with CE standards

ESD protected housing "skin effect"

# JBC

---

## Warranty

JBC's 2 year warranty covers this equipment against all manufacturing defects, including the replacement of defective parts and labour.

Warranty does not cover product wear or misuse.

In order for the warranty to be valid, equipment must be returned, postage paid, to the dealer where it was purchased.

**Get 1 extra year JBC warranty by registering here:**  
<https://www.jbctools.com/productregistration/>  
**within 30 days of purchase.**

---



This product should not be thrown in the garbage.

In accordance with the European directive 2012/19/EU, electronic equipment at the end of its life must be collected and returned to an authorized recycling facility.

CE EAC

[www.jbctools.com](http://www.jbctools.com)

0026066-0121