

LUXEON CS CoB

High efficacy, superior quality of light and ease for design footprints

LUXEON CS extends Lumileds CoB leadership for performance and reliability to an entirely new board footprint that enables easy design-in for new luminaire programs and as a cost-effective replacement for existing solutions where an upgrade is desired. State-of-the-art LUXEON CoB technology delivers unmatched performance, quality of light, and uncompromising product quality.



FEATURES AND BENEFITS

- Widely used square footprints for easy design-in
- High performance with superior color stability
- Low thermal resistance enables smaller heatsinks and extends the operating life span
- Supported by a comprehensive optical, mechanical, and electrical ecosystem

PRIMARY APPLICATIONS

- Track Lights
- Downlights
- Spotlights
- High Bay
- Low Bay
- More...

Table of Contents

General Product Information	2
Product Test Conditions	2
Part Number Nomenclature	2
Lumen Maintenance	2
Environmental Compliance	3
Use Limitations	3
Performance Characteristics	4
Product Selection Guide	4
Optical Characteristics	7
Electrical and Thermal Characteristics	7
Absolute Maximum Ratings	7
Characteristic Curves	8
Spectral Power Distribution Characteristics	8
Light Output Characteristics	9
Forward Current Characteristics	12
Radiation Pattern Characteristics	15
Color Bin Definitions	16
Mechanical Dimensions	17
Packaging Information	19
Tray Dimensions	19
Inner Box	21
Outer Box	22

General Product Information

Product Test Conditions

LUXEON CS CoB LEDs are tested and binned with a DC drive current specified below at a junction temperature, T_j , of 85°C:

180mA	-	L2C6-AABBCL02A0600
180mA	-	L2C6-AABBCL02A0900
360mA	-	L2C6-AABBCL04A0900
540mA	-	L2C6-AABBCL06A1300
720mA	-	L2C6-AABBCL10A1500
900mA	-	L2C6-AABBCL10A1500
990mA	-	L2C6-AABBCL11A2200
1170mA	-	L2C6-AABBCL13A2200
1440mA	-	L2C6-AABBCL16A2200
1080mA	-	L2C6-AABBCL12A2200
1620mA	-	L2C6-AABBCL18A2200

Part Number Nomenclature

Part numbers for LUXEON CS CoB follow the convention below:

L 2 C 6 - A A B B C D D D E F F G G

Where:

- A A** - designates nominal CCT (27=2700K, 30=3000K, 35=3500K, 40=4000K, 50=5000K, 57=5700K, 65=6500K)
- B B** - designates minimum CRI (80=80CRI, 90=90CRI)
- C** - designates SDCM (2=2-step MacAdam, 3=3-step MacAdam)
- D D D** - designates product configuration (example: L08=1208, R12=1812)
- E** - designates options for product specification
- F F** - designates light emitting surface (LES) size (06=6.3mm, 09=9.8mm, 13=13mm, 15=14.5mm, 22=22mm)
- G G** - designates options for product specification

Therefore, the following part number is used for a LUXEON CS CoB 1208, 3000K 80CRI, 3 SDCM with a 14.5mm LES:

L 2 C 6 - 3 0 8 0 3 L 0 8 A 1 5 0 0

Lumen Maintenance

Please contact your local Sales Representative or Lumileds Technical Solutions Manager for more information about the long-term performance of this product.

Environmental Compliance

Lumileds LLC is committed to providing environmentally friendly products to the solid-state lighting market. LUXEON CS CoB is compliant to the European Union directives on the restriction of hazardous substances in electronic equipment, namely the RoHS Directive 2011/65/EU and REACH Regulation (EC) 1907/2006. Lumileds LLC will not intentionally add the following restricted materials to its products: lead, mercury, cadmium, hexavalent chromium, polybrominated biphenyls (PBB) or polybrominated diphenyl ethers (PBDE).

Use Limitations

LUXEON CS CoB 90CRI is for use in commercial illumination products and cannot be used for medical equipment, airfields, runways, aircraft, stage and studio applications, or for consumer products sold through retailers, e-commerce or DIY and homebuilder channels. LUXEON CS CoB 90CRI is recommended for use in dry environments (not for use in wet environments).

Performance Characteristics

Product Selection Guide

Table 1. Product performance of LUXEON CS CoB at specified test current, $T_j=85^\circ\text{C}$.

LES ^[4] (mm)	NOMINAL CCT	MINIMUM CRI ^[1, 2, 3]	LUMINOUS FLUX ^[1] (lm)		TYPICAL LUMINOUS EFFICACY (lm/W)	TEST CURRENT (mA)	ENERGY EFFICIENCY CLASS ^[5]	PART NUMBER
			MINIMUM	TYPICAL				
6	2700K	80	801	890	146	180	D	L2C6-27803L02A0600
6	3000K	80	834	927	152	180	D	L2C6-30803L02A0600
6	3500K	80	855	950	156	180	D	L2C6-35803L02A0600
6	4000K	80	876	973	160	180	D	L2C6-40803L02A0600
6	5000K	80	876	973	160	180	D	L2C6-50803L02A0600
6	5700K	80	868	964	158	180	D	L2C6-57803L02A0600
6	6500K	80	859	955	156	180	D	L2C6-65803L02A0600
6	2700K	90	759	843	138	180	E	L2C6-27902L02A0600
6	3000K	90	803	892	146	180	D	L2C6-30902L02A0600
6	3500K	90	839	932	153	180	D	L2C6-35902L02A0600
6	4000K	90	864	960	157	180	D	L2C6-40902L02A0600
6	5000K	90	867	963	158	180	D	L2C6-50902L02A0600
9	2700K	80	857	952	156	180	D	L2C6-27803L02A0900
9	3000K	80	887	986	162	180	D	L2C6-30803L02A0900
9	3500K	80	905	1006	165	180	D	L2C6-35803L02A0900
9	4000K	80	950	1055	173	180	C	L2C6-40803L02A0900
9	5000K	80	950	1055	173	180	C	L2C6-50803L02A0900
9	5700K	80	930	1033	169	180	D	L2C6-57803L02A0900
9	6500K	80	921	1023	168	180	D	L2C6-65803L02A0900
9	2700K	90	804	893	146	180	D	L2C6-27902L02A0900
9	3000K	90	823	914	150	180	D	L2C6-30902L02A0900
9	3500K	90	856	951	156	180	D	L2C6-35902L02A0900
9	4000K	90	881	979	160	180	D	L2C6-40902L02A0900
9	5000K	90	884	982	161	180	D	L2C6-50902L02A0900
9	2700K	80	1693	1881	154	360	D	L2C6-27803L04A0900
9	3000K	80	1767	1963	161	360	D	L2C6-30803L04A0900
9	3500K	80	1793	1992	163	360	D	L2C6-35803L04A0900
9	4000K	80	1852	2058	169	360	D	L2C6-40803L04A0900
9	5000K	80	1852	2058	169	360	D	L2C6-50803L04A0900
9	5700K	80	1833	2037	167	360	D	L2C6-57803L04A0900
9	6500K	80	1815	2017	165	360	D	L2C6-65803L04A0900
9	2700K	90	1652	1836	150	360	D	L2C6-27902L04A0900
9	3000K	90	1701	1890	155	360	D	L2C6-30902L04A0900
9	3500K	90	1771	1968	161	360	D	L2C6-35902L04A0900
9	4000K	90	1812	2013	165	360	D	L2C6-40902L04A0900
9	5000K	90	1817	2019	165	360	D	L2C6-50902L04A0900

Table 1 continued on next page:

1. Lumileds maintains a tolerance of ± 2 on CRI and $\pm 6.5\%$ on luminous flux measurements.
2. Typical CRI is approximately 2 points higher than the minimum CRI specified, but this is not guaranteed.
3. R9 value of 90CRI products is >50 .
4. Light Emitting Surface (LES) is the inner diameter (phosphor area) inside the dam.
5. Energy efficiency class as specified in Commission Delegated Regulation (EU) 2019/2015. The available range of energy efficiency classes is A-G.

Table 1. Product performance of LUXEON CS CoB at specified test current, $T_j=85^\circ\text{C}$, Continued.

LES ^[4] (mm)	NOMINAL CCT	MINIMUM CRI ^[1, 2, 3]	LUMINOUS FLUX ^[1] (lm)		TYPICAL LUMINOUS EFFICACY (lm/W)	TEST CURRENT (mA)	ENERGY EFFICIENCY CLASS ^[5]	PART NUMBER
			MINIMUM	TYPICAL				
13	2700K	80	2590	2878	157	540	D	L2C6-27803L06A1300
13	3000K	80	2692	2991	163	540	D	L2C6-30803L06A1300
13	3500K	80	2754	3060	167	540	D	L2C6-35803L06A1300
13	4000K	80	2814	3127	171	540	D	L2C6-40803L06A1300
13	5000K	80	2815	3128	171	540	D	L2C6-50803L06A1300
13	5700K	80	2807	3119	170	540	D	L2C6-57803L06A1300
13	6500K	80	2778	3087	169	540	D	L2C6-65803L06A1300
13	2700K	90	2428	2698	147	540	D	L2C6-27902L06A1300
13	3000K	90	2528	2809	153	540	D	L2C6-30902L06A1300
13	3500K	90	2635	2928	160	540	D	L2C6-35902L06A1300
13	4000K	90	2717	3019	165	540	D	L2C6-40902L06A1300
13	5000K	90	2728	3031	166	540	D	L2C6-50902L06A1300
15	2700K	80	3416	3795	155	720	D	L2C6-27803L08A1500
15	3000K	80	3595	3994	164	720	D	L2C6-30803L08A1500
15	3500K	80	3675	4083	167	720	D	L2C6-35803L08A1500
15	4000K	80	3747	4163	171	720	D	L2C6-40803L08A1500
15	5000K	80	3747	4163	171	720	D	L2C6-50803L08A1500
15	5700K	80	3737	4152	170	720	D	L2C6-57803L08A1500
15	6500K	80	3645	4050	166	720	D	L2C6-65803L08A1500
15	2700K	90	3221	3579	147	720	D	L2C6-27902L08A1500
15	3000K	90	3336	3707	152	720	D	L2C6-30902L08A1500
15	3500K	90	3475	3861	158	720	D	L2C6-35902L08A1500
15	4000K	90	3602	4002	164	720	D	L2C6-40902L08A1500
15	5000K	90	3613	4014	164	720	D	L2C6-50902L08A1500
15	2700K	80	4198	4664	153	900	D	L2C6-27803L10A1500
15	3000K	80	4417	4908	161	900	D	L2C6-30803L10A1500
15	3500K	80	4505	5006	164	900	D	L2C6-35803L10A1500
15	4000K	80	4671	5190	170	900	D	L2C6-40803L10A1500
15	5000K	80	4671	5190	170	900	D	L2C6-50803L10A1500
15	5700K	80	4594	5104	167	900	D	L2C6-57803L10A1500
15	6500K	80	4550	5055	166	900	D	L2C6-65803L10A1500
15	2700K	90	4041	4490	147	900	D	L2C6-27902L10A1500
15	3000K	90	4168	4631	152	900	D	L2C6-30902L10A1500
15	3500K	90	4281	4757	156	900	D	L2C6-35902L10A1500
15	4000K	90	4450	4944	162	900	D	L2C6-40902L10A1500
15	5000K	90	4463	4959	163	900	D	L2C6-50902L10A1500

Table 1 continued on next page:

1. Lumileds maintains a tolerance of ± 2 on CRI and $\pm 6.5\%$ on luminous flux measurements.
2. Typical CRI is approximately 2 points higher than the minimum CRI specified, but this is not guaranteed.
3. R9 value of 90CRI products is >50 .
4. Light Emitting Surface (LES) is the inner diameter (phosphor area) inside the dam.
5. Energy efficiency class as specified in Commission Delegated Regulation (EU) 2019/2015. The available range of energy efficiency classes is A-G.

Table 1. Product performance of LUXEON CS CoB at specified test current, T_j=85°C, Continued.

LES ^[4] (mm)	NOMINAL CCT	MINIMUM CRI ^[1, 2, 3]	LUMINOUS FLUX ^[1] (lm)		TYPICAL LUMINOUS EFFICACY (lm/W)	TEST CURRENT (mA)	ENERGY EFFICIENCY CLASS ^[5]	PART NUMBER
			MINIMUM	TYPICAL				
22	2700K	90	4511	5012	149	990	D	L2C6-27902L11A2200
22	3000K	90	4720	5244	156	990	D	L2C6-30902L11A2200
22	3500K	90	4928	5476	163	990	D	L2C6-35902L11A2200
22	4000K	90	5049	5610	167	990	D	L2C6-40902L11A2200
22	5000K	90	5061	5623	168	990	D	L2C6-50902L11A2200
22	2700K	80	5678	6309	159	1170	D	L2C6-27803L13A2200
22	3000K	80	5914	6571	166	1170	D	L2C6-30803L13A2200
22	3500K	80	5943	6603	166	1170	D	L2C6-35803L13A2200
22	4000K	80	6214	6904	174	1170	C	L2C6-40803L13A2200
22	5000K	80	6214	6904	174	1170	C	L2C6-50803L13A2200
22	5700K	80	6091	6768	171	1170	D	L2C6-57803L13A2200
22	6500K	80	6030	6700	169	1170	D	L2C6-65803L13A2200
22	2700K	90	5309	5899	149	1170	D	L2C6-27902L13A2200
22	3000K	90	5578	6198	156	1170	D	L2C6-30902L13A2200
22	3500K	90	5801	6446	163	1170	D	L2C6-35902L13A2200
22	4000K	90	5940	6600	166	1170	D	L2C6-40902L13A2200
22	5000K	90	5957	6619	167	1170	D	L2C6-50902L13A2200
22	2700K	80	7010	7789	160	1440	D	L2C6-27803L16A2200
22	3000K	80	7176	7973	163	1440	D	L2C6-30803L16A2200
22	3500K	80	7183	7981	163	1440	D	L2C6-35803L16A2200
22	4000K	80	7455	8283	170	1440	D	L2C6-40803L16A2200
22	5000K	80	7455	8283	170	1440	D	L2C6-50803L16A2200
22	5700K	80	7433	8259	169	1440	D	L2C6-57803L16A2200
22	6500K	80	7322	8135	167	1440	D	L2C6-65803L16A2200
22	2700K	90	6440	7156	147	1440	D	L2C6-27902L16A2200
22	3000K	90	6697	7441	152	1440	D	L2C6-30902L16A2200
22	3500K	90	7033	7814	160	1440	D	L2C6-35902L16A2200
22	4000K	90	7132	7924	162	1440	D	L2C6-40902L16A2200
22	5000K	90	7151	7946	163	1440	D	L2C6-50902L16A2200
22	2700K	80	7538	8376	152	1080	D	L2C6-27803R12A2200
22	3000K	80	7853	8725	158	1080	D	L2C6-30803R12A2200
22	3500K	80	8050	8944	162	1080	D	L2C6-35803R12A2200
22	4000K	80	8599	9554	173	1080	C	L2C6-40803R12A2200
22	5000K	80	8599	9554	173	1080	C	L2C6-50803R12A2200
22	5700K	80	8167	9074	165	1080	D	L2C6-57803R12A2200
22	6500K	80	8088	8987	163	1080	D	L2C6-65803R12A2200
22	2700K	80	11093	12325	149	1620	D	L2C6-27803R18A2200
22	3000K	80	11554	12838	155	1620	D	L2C6-30803R18A2200
22	3500K	80	11843	13159	159	1620	D	L2C6-35803R18A2200
22	4000K	80	12132	13480	163	1620	D	L2C6-40803R18A2200
22	5000K	80	12132	13480	163	1620	D	L2C6-50803R18A2200
22	5700K	80	12017	13352	162	1620	D	L2C6-57803R18A2200
22	6500K	80	11902	13224	160	1620	D	L2C6-65803R18A2200

Notes for Table 1:

1. Lumileds maintains a tolerance of ±2 on CRI and ±6.5% on luminous flux measurements.
2. Typical CRI is approximately 2 points higher than the minimum CRI specified, but this is not guaranteed.
3. R9 value of 90CRI products is >50.
4. Light Emitting Surface (LES) is the inner diameter (phosphor area) inside the dam.
5. Energy efficiency class as specified in Commission Delegated Regulation (EU) 2019/2015. The available range of energy efficiency classes is A-G.

Optical Characteristics

Table 2. Optical characteristics for LUXEON CS CoB at specified test current, $T_j=85^\circ\text{C}$.

PART NUMBER	TYPICAL TOTAL INCLUDED ANGLE ^[1]	TYPICAL VIEWING ANGLE ^[2]
L2C6-xxxxxxxAxx00	135°	115°

Notes for Table 2:

- Total angle at which 90% of total luminous flux is captured.
- Viewing angle is the off axis angle from the LED centerline where the luminous intensity is ½ of the peak value.

Electrical and Thermal Characteristics

Table 3. Electrical and thermal characteristics for LUXEON CS CoB at specified test current, $T_j=85^\circ\text{C}$.

PART NUMBER	FORWARD VOLTAGE ^[1] (V_f)			TYPICAL TEMPERATURE COEFFICIENT OF FORWARD VOLTAGE ^[2] (mV/°C)	TYPICAL THERMAL RESISTANCE—JUNCTION TO CASE ^[3] (°C/W)
	MINIMUM	TYPICAL	MAXIMUM		
L2C6-xxxxxL02A0600	32.5	33.9	35.5	10	0.78
L2C6-xxxxxL02A0900	32.5	33.9	35.5	10	0.78
L2C6-xxxxxL04A0900	32.5	33.9	35.5	10	0.43
L2C6-xxxxxL06A1300	32.5	33.9	35.5	10	0.24
L2C6-xxxxxL08A1500	32.5	33.9	35.5	10	0.20
L2C6-xxxxxL10A1500	32.5	33.9	35.5	10	0.18
L2C6-xxxxxL11A2200	32.5	33.9	35.5	10	0.16
L2C6-xxxxxL13A2200	32.5	33.9	35.5	10	0.15
L2C6-xxxxxL16A2200	32.5	33.9	35.5	10	0.12
L2C6-xxxxxR12A2200	48.5	51.0	53.5	15	0.10
L2C6-xxxxxR18A2200	48.5	51.0	53.5	15	0.03

Notes for Table 3:

- Lumileds maintains a tolerance of $\pm 0.06\text{V}$ on forward voltage measurements.
- Measured between 25°C and 85°C.
- Thermal resistance is measured between junction and the bottom of the LUXEON CoB substrate.

Absolute Maximum Ratings

Table 4. Absolute maximum ratings for LUXEON CS CoB.

PARAMETER	MAXIMUM PERFORMANCE
DC Forward Current ^[1, 2, 3]	2.5x test current
LED Junction Temperature ^[1] (DC & Pulse)	125°C
ESD Sensitivity (ANSI/ESDA/JEDEC JS-001-2012)	Class 3B
Operating Case Temperature ^[1]	-40°C to 105°C
LED Storage Temperature	-40°C to 120°C
Reverse Voltage (V_{reverse})	LUXEON LEDs are not designed to be driven in reverse bias

Notes for Table 4:

- Proper current derating must be observed to maintain the junction temperature below the maximum allowable junction temperature.
- Residual periodic variations due to power conversion from alternating current (AC) to direct current (DC), also called "ripple," are acceptable if the following conditions are met:
 - The frequency of the ripple current is 100Hz or higher
 - The average current for each cycle does not exceed the maximum allowable DC forward current
 - The maximum amplitude of the ripple does not exceed the maximum peak pulsed forward current
- Exception: LUXEON CS CoB 1812 and 1818 have maximum DC forward current of 2.2x of test current.

Characteristic Curves

Spectral Power Distribution Characteristics

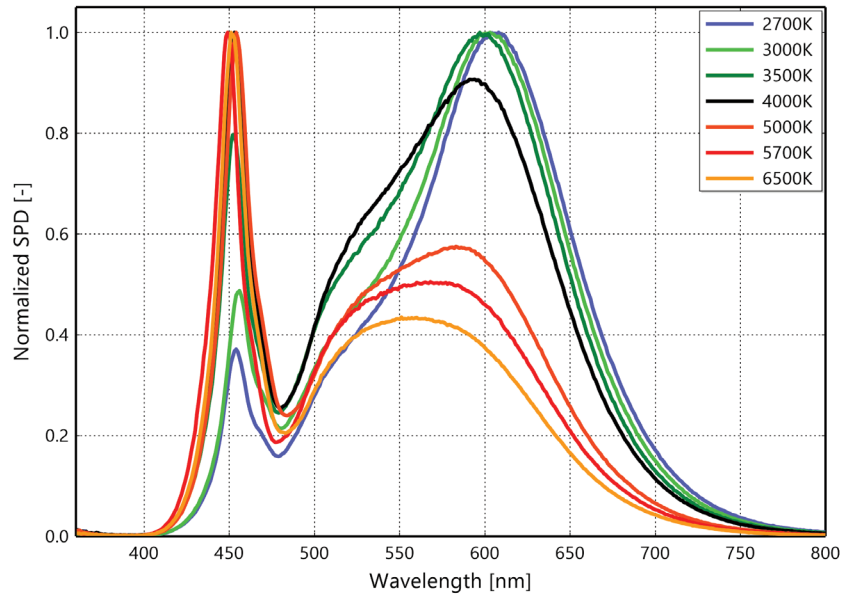

Figure 1a. Typical normalized power vs. wavelength for L2C6-xx80xxxxAxx00 at specified test current, $T_j=85^{\circ}\text{C}$.

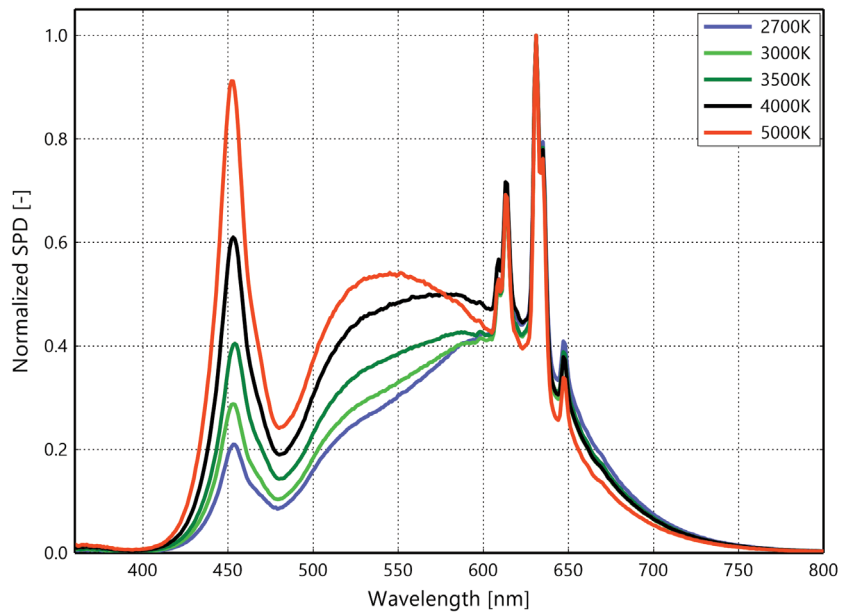

Figure 1b. Typical normalized power vs. wavelength for L2C6-xx90xxxxAxx00 at specified test current, $T_j=85^{\circ}\text{C}$.

Light Output Characteristics

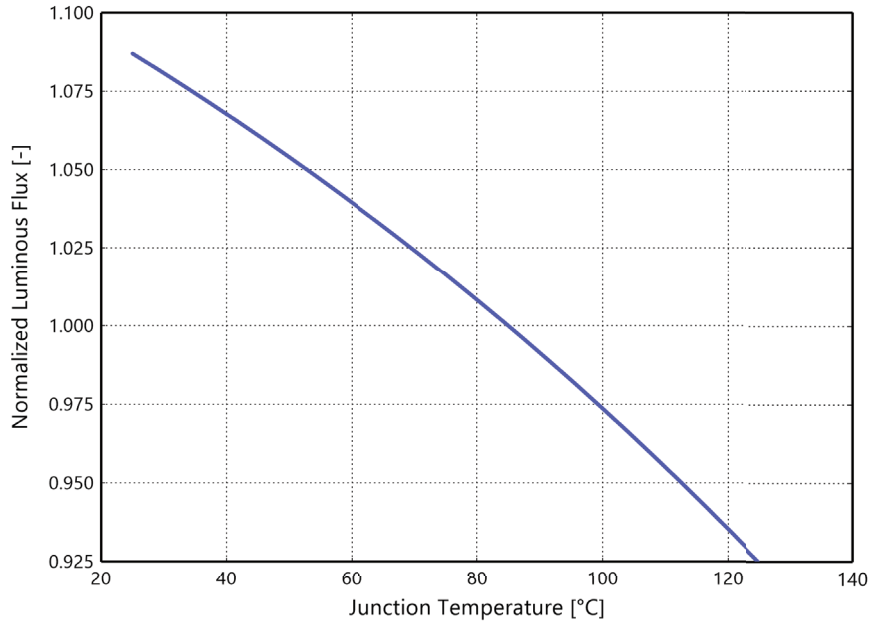

Figure 2. Typical normalized light output vs. junction temperature for L2C6-xxxxLxxAxx00 at specified test current.

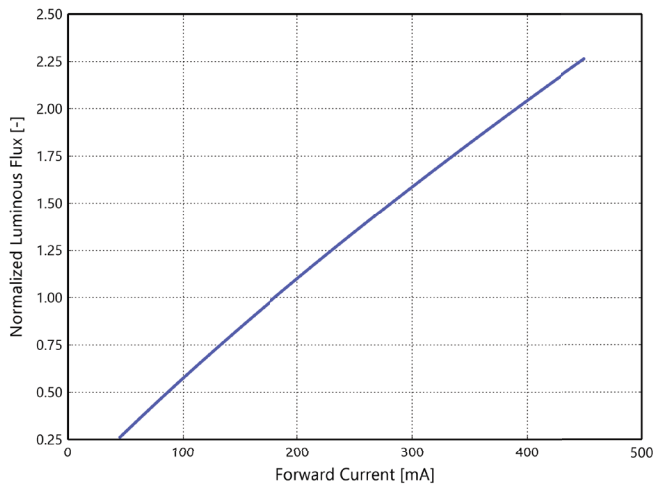

Figure 3a. Typical normalized light output vs. forward current for L2C6-xxxxL02A0600 at $T_j=85^\circ\text{C}$.

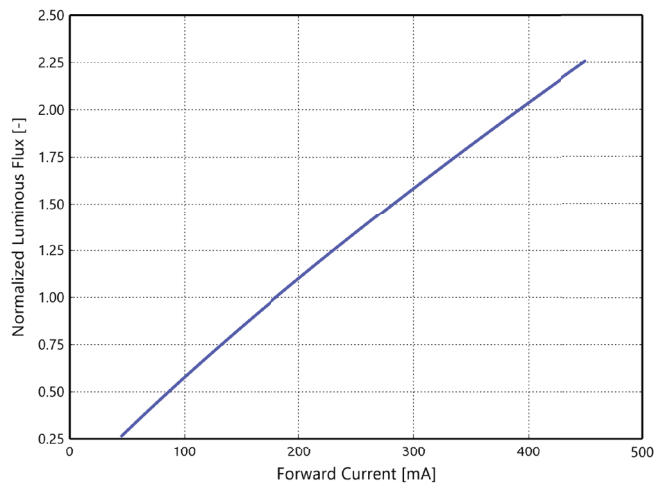

Figure 3b. Typical normalized light output vs. forward current for L2C6-xxxxL02A0900 at $T_j=85^\circ\text{C}$.

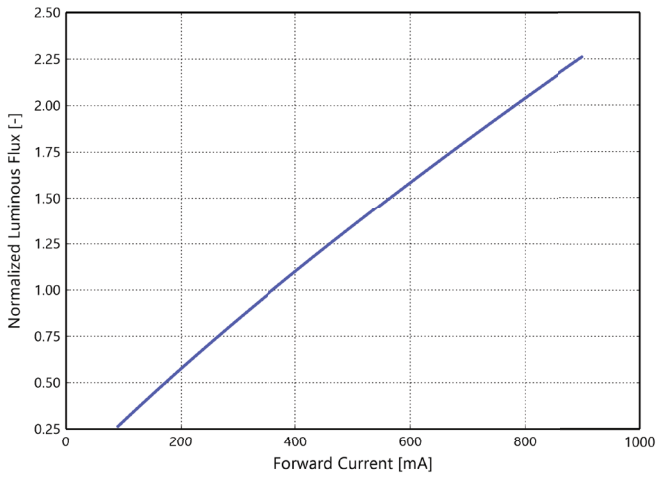

Figure 3c. Typical normalized light output vs. forward current for L2C6-xxxxxL04A0900 at $T_j=85^\circ\text{C}$.

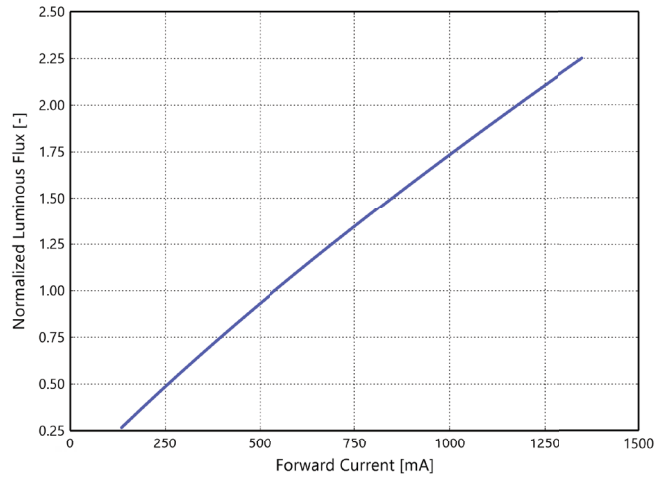

Figure 3d. Typical normalized light output vs. forward current for L2C6-xxxxxL06A1300 at $T_j=85^\circ\text{C}$.

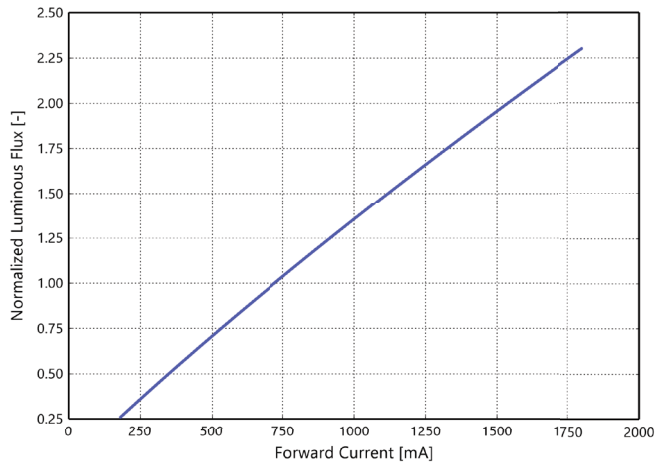

Figure 3e. Typical normalized light output vs. forward current for L2C6-xxxxxL08A1500 at $T_j=85^\circ\text{C}$.

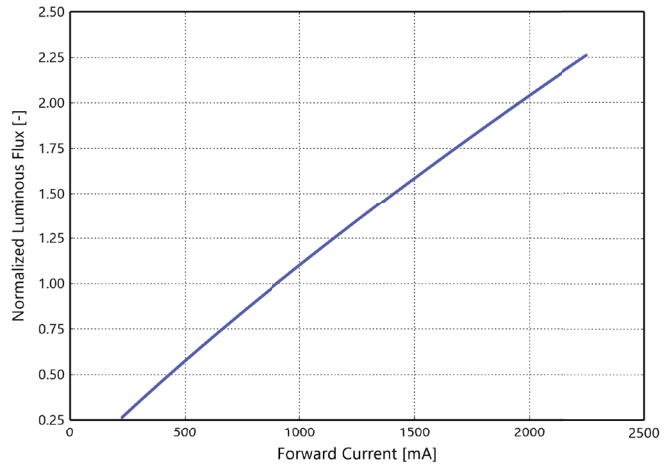

Figure 3f. Typical normalized light output vs. forward current for L2C6-xxxxxL10A1500 at $T_j=85^\circ\text{C}$.

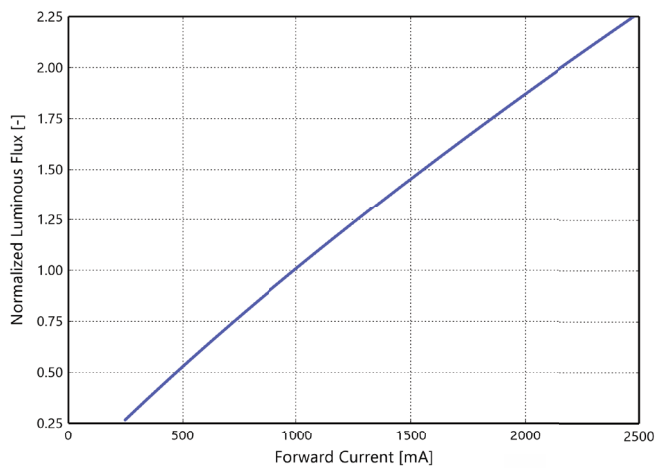

Figure 3g. Typical normalized light output vs. forward current for L2C6-xxxxxL11A2200 at $T_j=85^\circ\text{C}$.

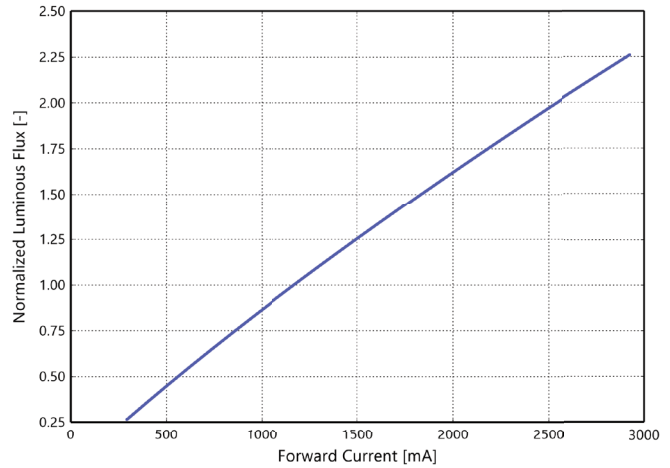

Figure 3h. Typical normalized light output vs. forward current for L2C6-xxxxxL13A2200 at $T_j=85^\circ\text{C}$.

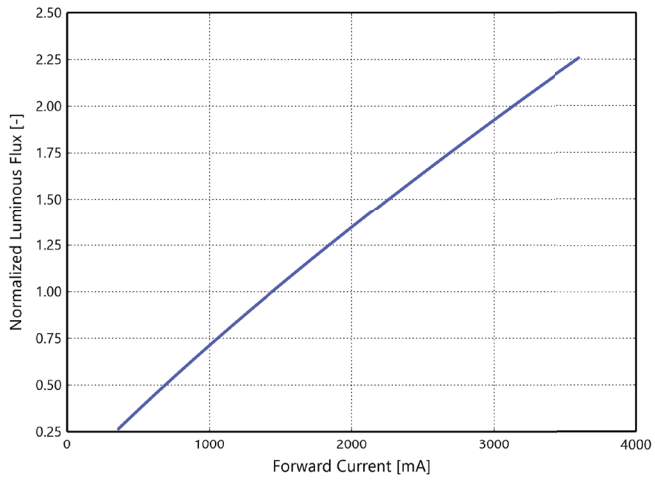

Figure 3i. Typical normalized light output vs. forward current for L2C6-xxxxxL16A2200 at $T_j=85^\circ\text{C}$.

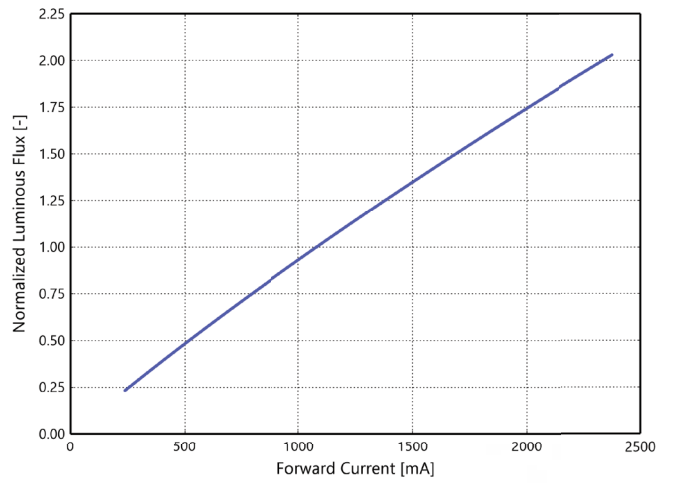

Figure 3j. Typical normalized light output vs. forward current for L2C6-xxxxxR12A2200 at $T_j=85^\circ\text{C}$.

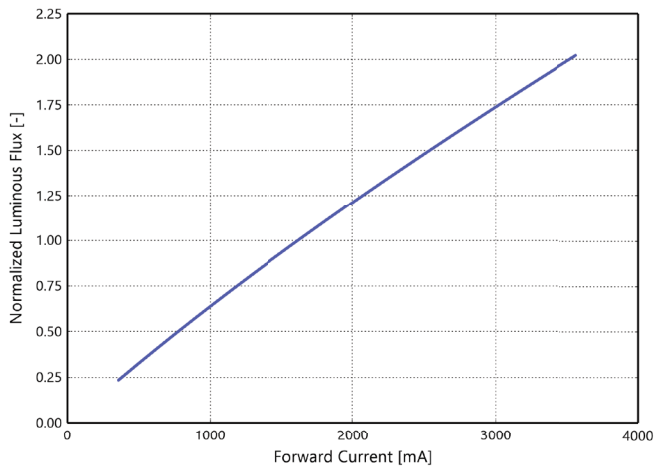

Figure 3k. Typical normalized light output vs. forward current for L2C6-xxxxxR18A2200 at $T_j=85^\circ\text{C}$.

Forward Current Characteristics

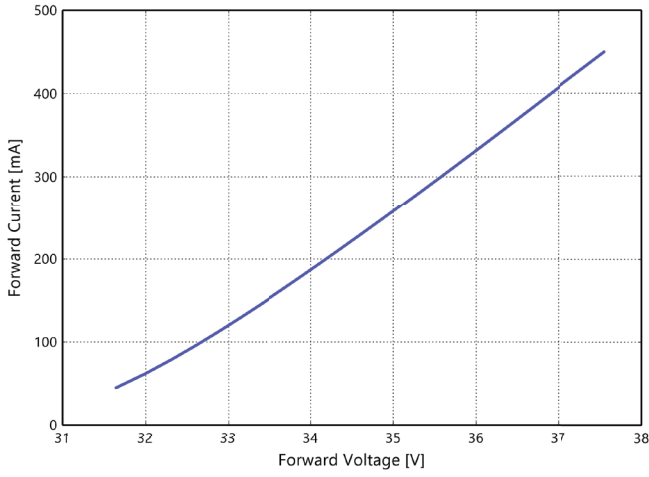

Figure 4a. Typical forward current vs. forward voltage for L2C6-xxxxxL02A0600 at $T_j=85^\circ\text{C}$.

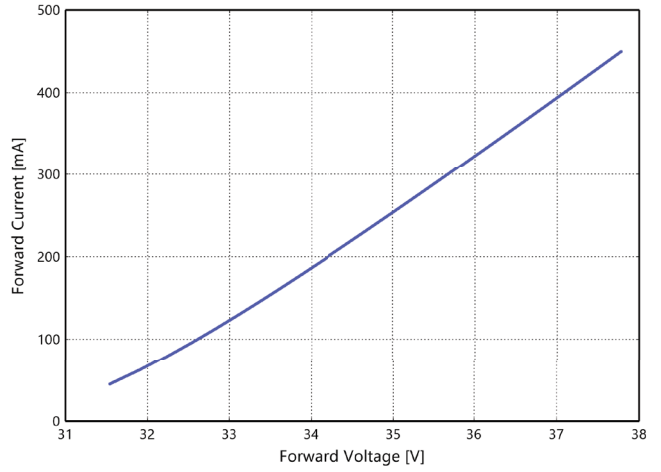

Figure 4b. Typical forward current vs. forward voltage for L2C6-xxxxxL02A0900 at $T_j=85^\circ\text{C}$.

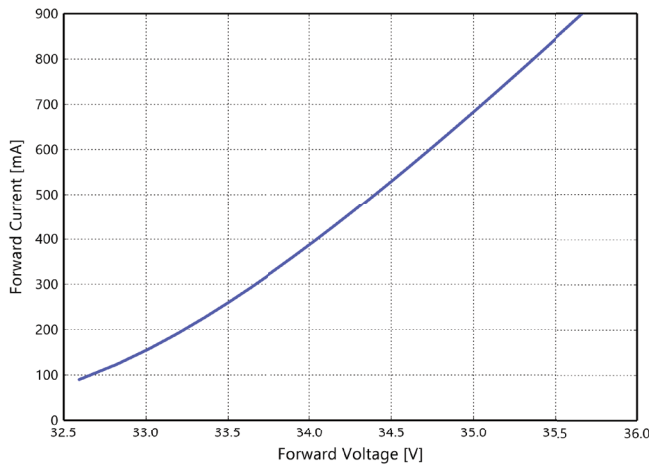

Figure 4c. Typical forward current vs. forward voltage for L2C6-xxxxxL04A0900 at $T_j=85^\circ\text{C}$.

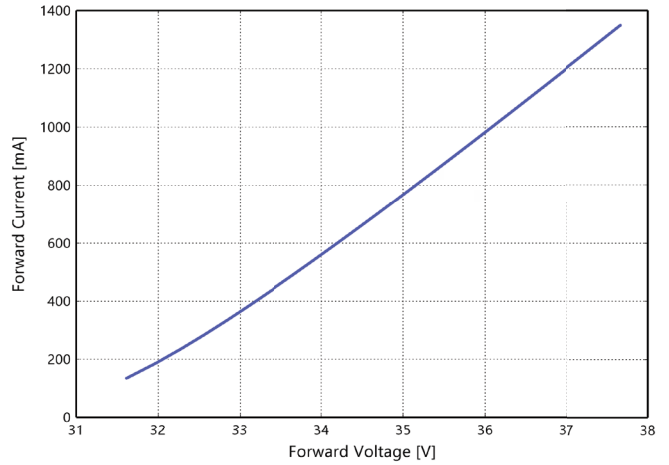

Figure 4d. Typical forward current vs. forward voltage for L2C6-xxxxxL06A1300 at $T_j=85^\circ\text{C}$.

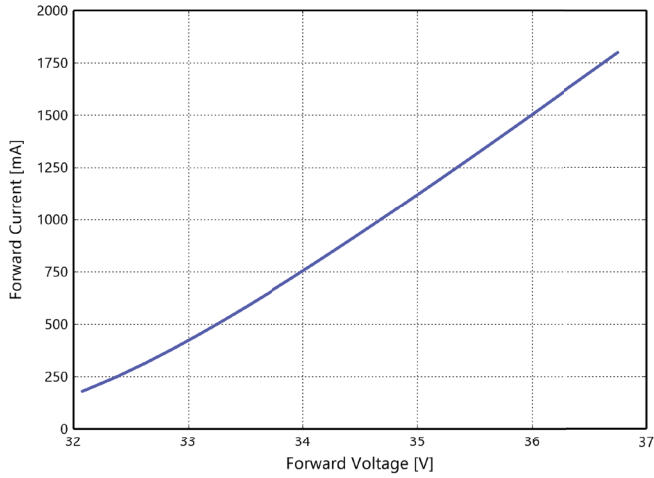

Figure 4e. Typical forward current vs. forward voltage for L2C6-xxxxxL08A1500 at $T_j=85^\circ\text{C}$.

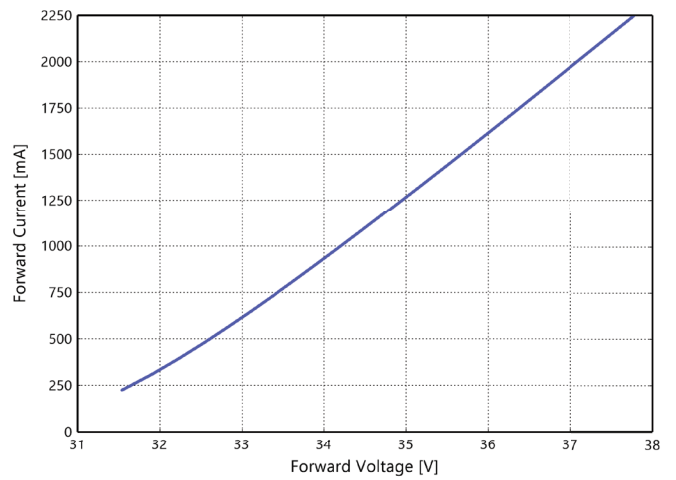

Figure 4f. Typical forward current vs. forward voltage for L2C6-xxxxxL10A1500 at $T_j=85^\circ\text{C}$.

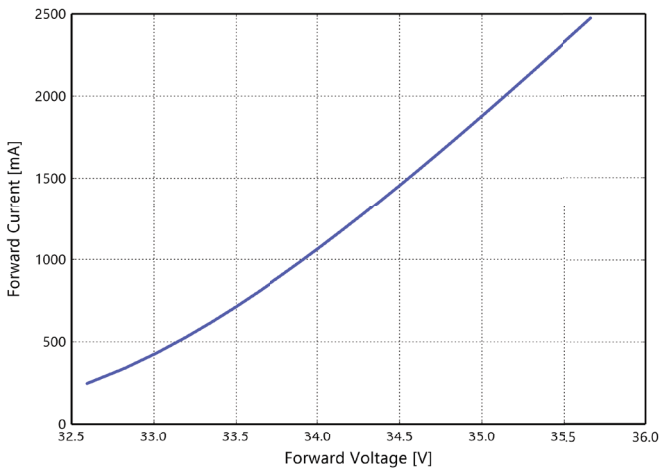

Figure 4g. Typical forward current vs. forward voltage for L2C6-xxxxxL11A2200 at $T_j=85^\circ\text{C}$.

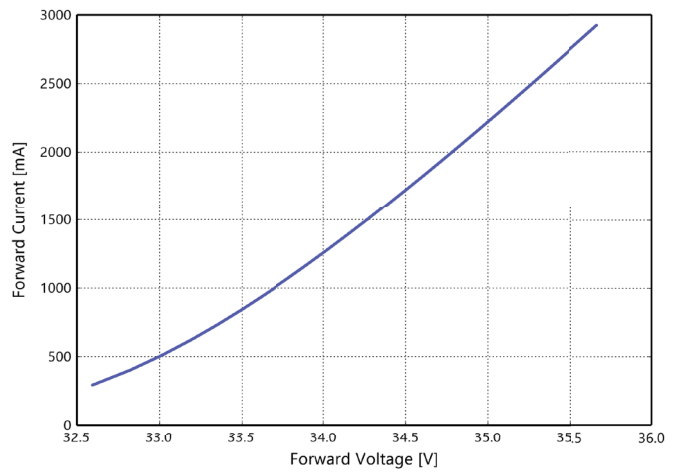

Figure 4h. Typical forward current vs. forward voltage for L2C6-xxxxxL13A2200 at $T_j=85^\circ\text{C}$.

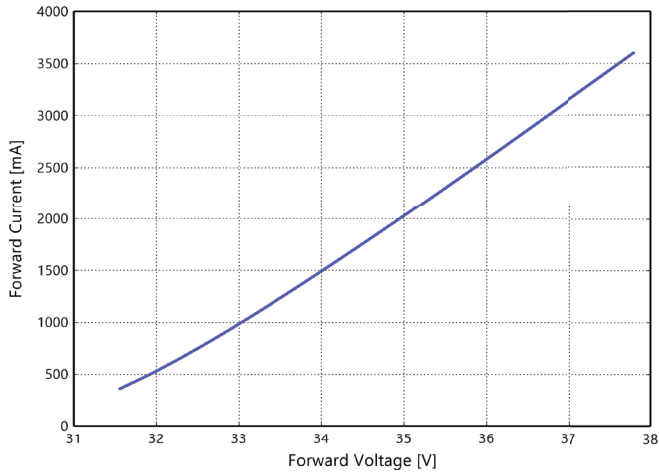

Figure 4i. Typical forward current vs. forward voltage for L2C6-xxxxxL16A2200 at $T_j=85^\circ\text{C}$.

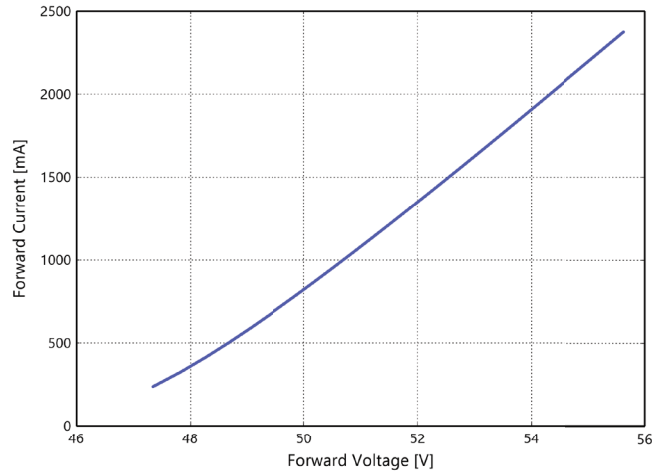

Figure 4j. Typical forward current vs. forward voltage for L2C6-xxxxxR12A2200 at $T_j=85^\circ\text{C}$.

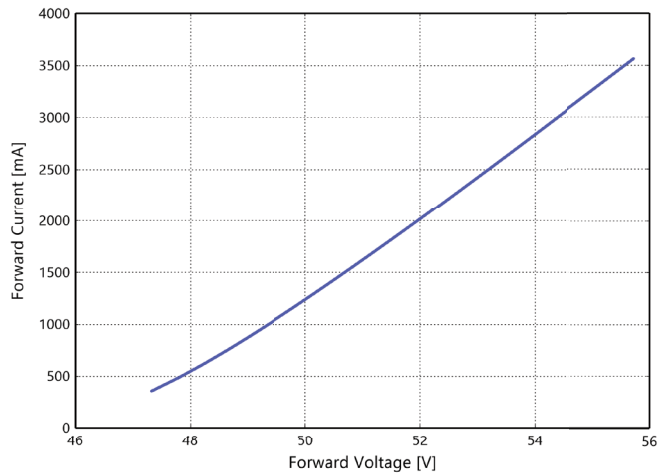

Figure 4k. Typical forward current vs. forward voltage for L2C6-xxxxxR18A2200 at $T_j=85^\circ\text{C}$.

Radiation Pattern Characteristics

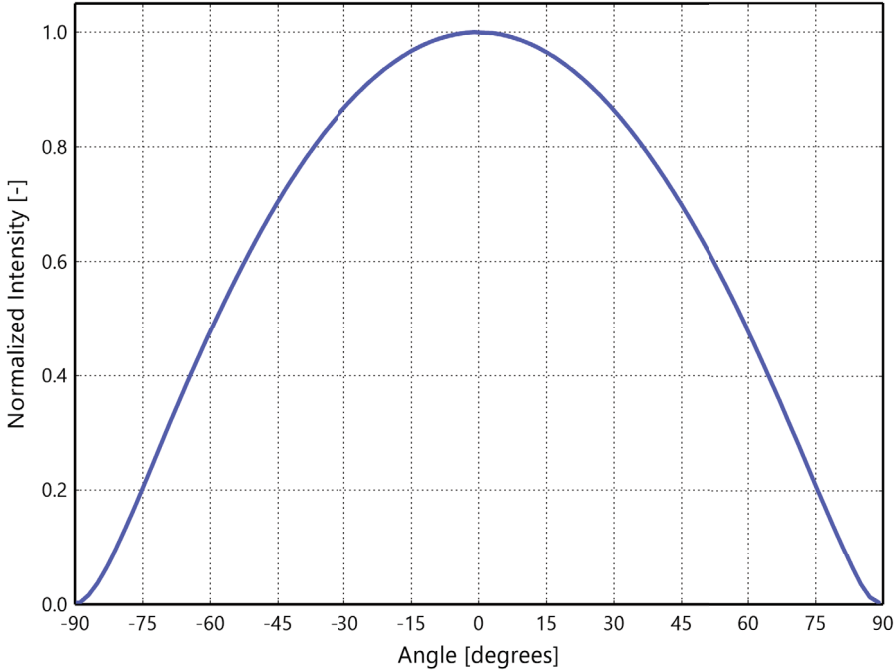

Figure 5. Typical radiation pattern for LUXEON CS CoB at specified test current, $T_j=85^{\circ}\text{C}$.

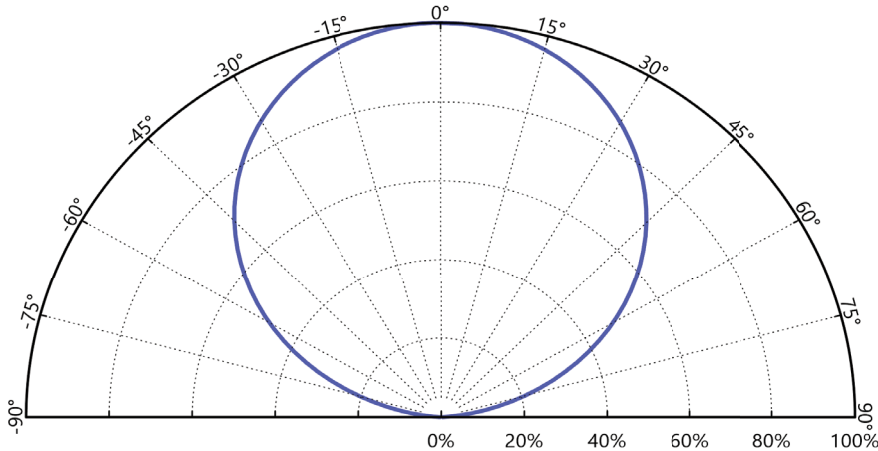

Figure 6. Typical polar radiation pattern for LUXEON CS CoB at specified test current, $T_j=85^{\circ}\text{C}$.

Color Bin Definitions

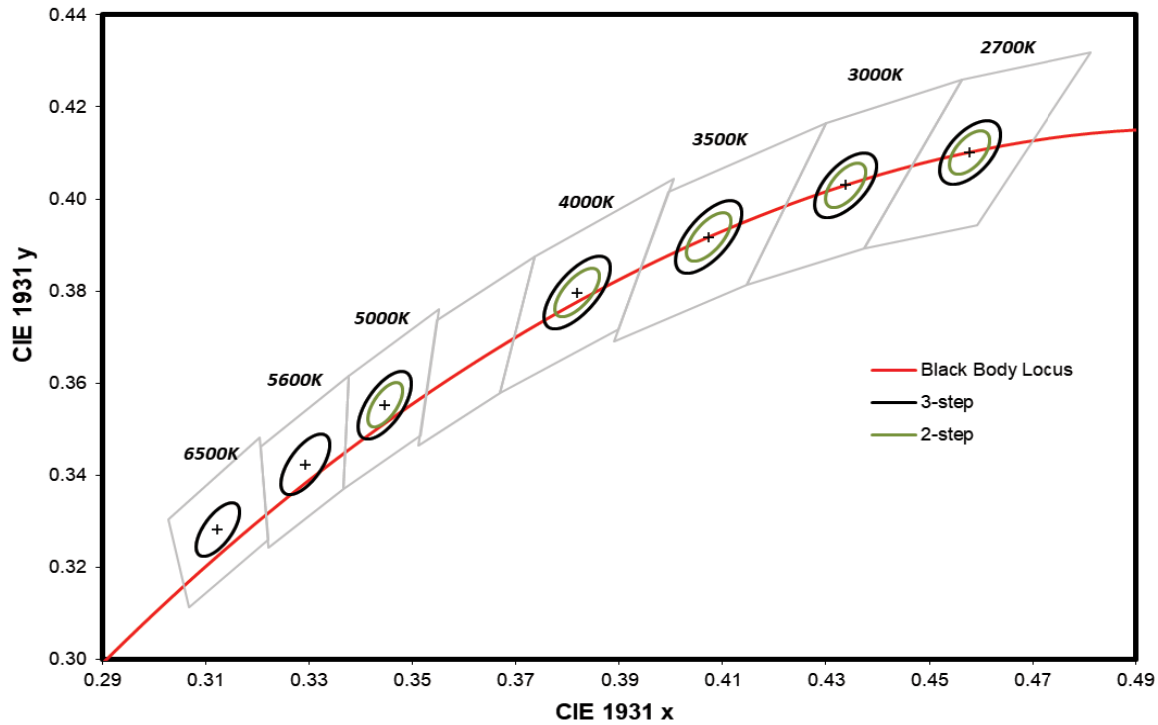

Figure 7. 2-step and 3-step MacAdam ellipse illustration for Table 5.

Table 5. 2-step and 3-step MacAdam ellipse color bin definitions for LUXEON CS CoB.

NOMINAL CCT	COLOR SPACE	CENTER POINT ⁽¹⁾ (cx, cy)	MAJOR AXIS, a	MINOR AXIS, b	ELLIPSE ROTATION ANGLE, θ
2700K	Single 3-step MacAdam ellipse	(0.4578, 0.4101)	0.00810	0.00420	53.70°
3000K	Single 3-step MacAdam ellipse	(0.4338, 0.4030)	0.00834	0.00408	53.22°
3500K	Single 3-step MacAdam ellipse	(0.4073, 0.3917)	0.00927	0.00414	54.00°
4000K	Single 3-step MacAdam ellipse	(0.3818, 0.3797)	0.00939	0.00402	53.72°
5000K	Single 3-step MacAdam ellipse	(0.3447, 0.3553)	0.00822	0.00354	59.62°
5600K	Single 3-step MacAdam ellipse	(0.3293, 0.3423)	0.00745	0.00320	59.10°
5700K	Single 3-step MacAdam ellipse	(0.3287, 0.3417)	0.00745	0.00320	59.09°
6500K	Single 3-step MacAdam ellipse	(0.3123, 0.3282)	0.00669	0.00285	58.57°
2700K	Single 2-step MacAdam ellipse	(0.4578, 0.4101)	0.00540	0.00280	53.70°
3000K	Single 2-step MacAdam ellipse	(0.4338, 0.4030)	0.00556	0.00272	53.22°
3500K	Single 2-step MacAdam ellipse	(0.4073, 0.3917)	0.00618	0.00276	54.00°
4000K	Single 2-step MacAdam ellipse	(0.3818, 0.3797)	0.00626	0.00268	53.72°
5000K	Single 2-step MacAdam ellipse	(0.3447, 0.3553)	0.00548	0.00236	59.62°

Notes for Table 5:

1. Lumileds maintains a tolerance of ± 0.005 on x and y coordinates in the CIE 1931 color space.

Mechanical Dimensions

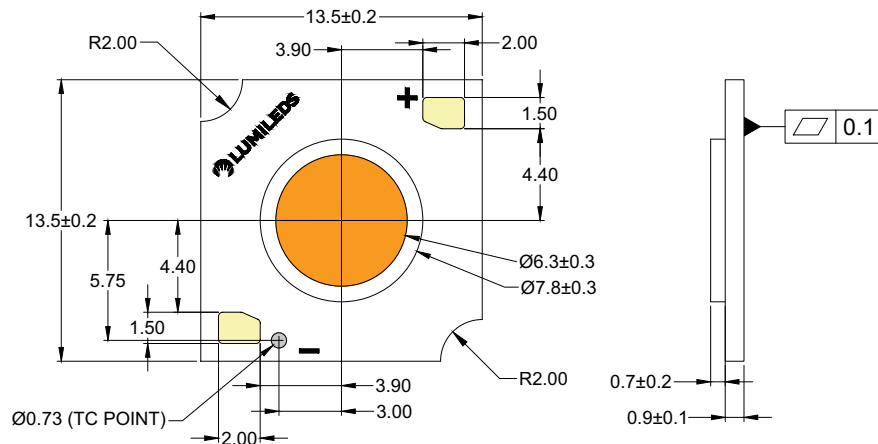

Figure 8a. Mechanical dimensions for L2C6-xxxxxL02x0600.

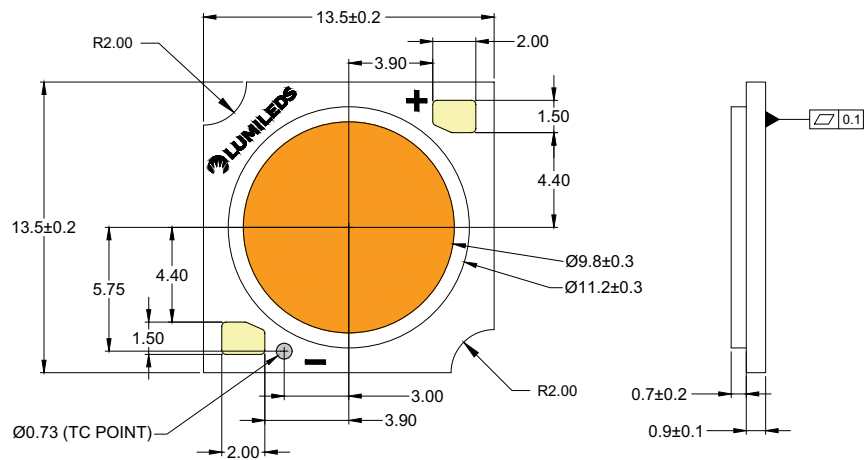

Figure 8b. Mechanical dimensions for L2C6-xxxxxL02x0900 and L2C6-xxxxxL04x0900.

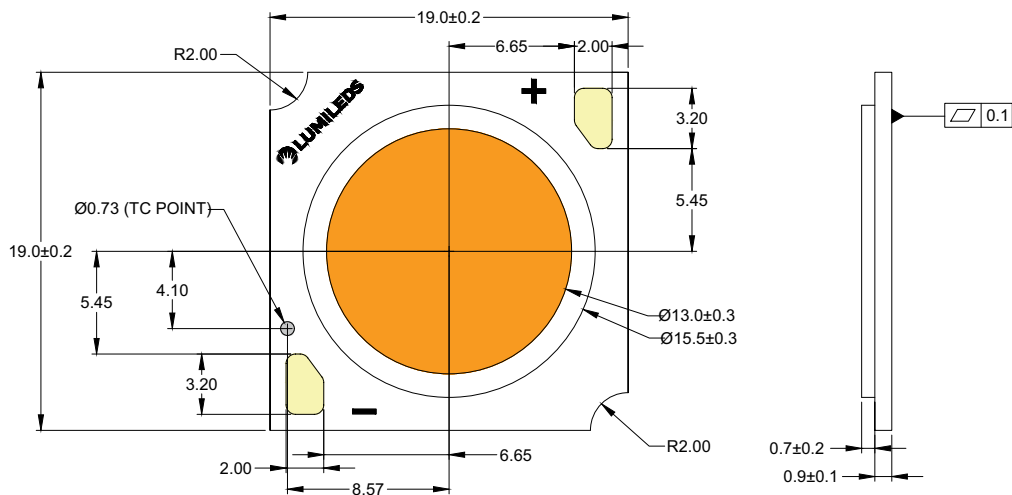

Figure 8c. Mechanical dimensions for L2C6-xxxxxL06x1300.

- Notes for Figures 8a, 8b and 8c:
1. Drawings are not to scale.
 2. All dimensions are in millimeters.

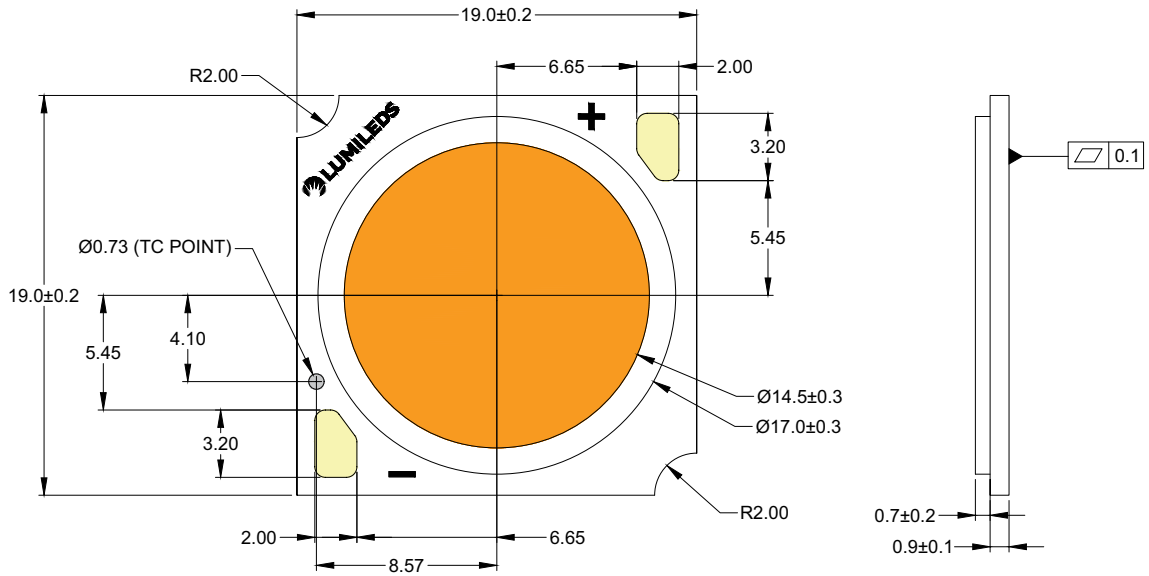

Figure 8d. Mechanical dimensions for L2C6-xxxxxL08x1500 and L2C6-xxxxxL10x1500.

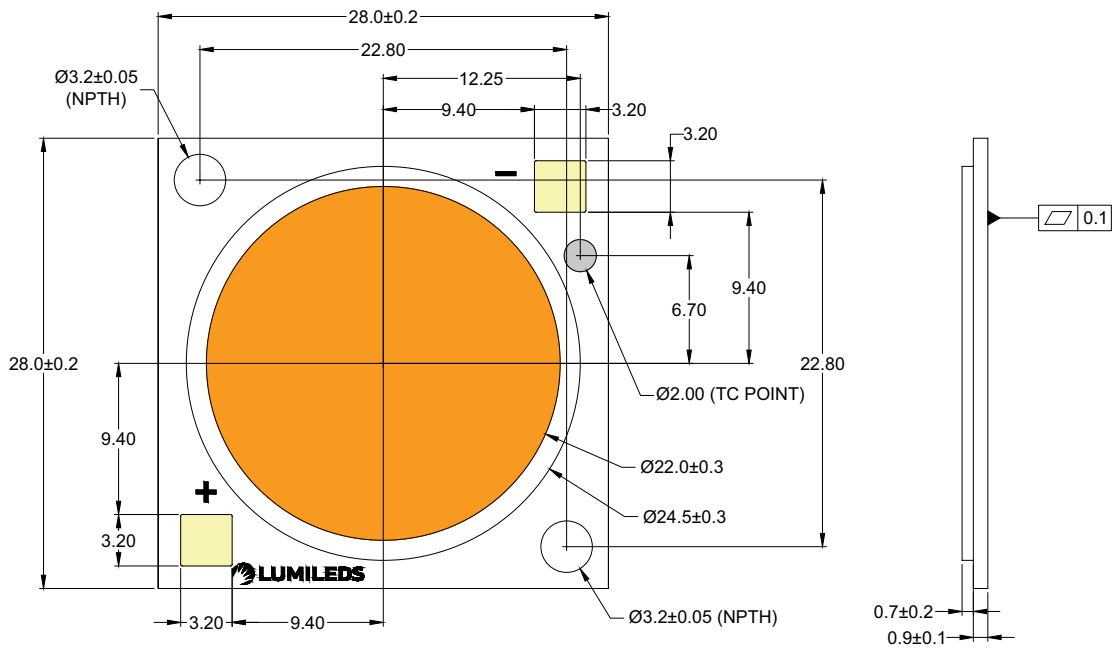

Figure 8e. Mechanical dimensions for L2C6-xxxxxL11x2200, L2C6-xxxxxL13x2200, L2C6-xxxxxL16x2200, L2C6-xxxxxR12x2200 and L2C6-xxxxxR18x2200

Notes for Figures 8d and 8e:

1. Drawings are not to scale.
2. All dimensions are in millimeters.
3. Dam heights: 0.7mm is applicable to L2C6-xx90xxxxxxxxxx, 0.5mm to L2C6-xx80xxxxxxxxxx.

Packaging Information

LUXEON CS CoB LEDs are packaged in trays then in a carton box. Each tray contains a specified number of LEDs. The LEDs in each tray come from a single category code, ensuring they are all well-matched for light output, color, and forward voltage. Each tray contains a rubber stopper at one end. The tray label has both alphanumeric and bar code information. The carton boxes have printed information providing part numbers with CAT codes that indicate luminous flux, color and forward voltage bins.

Table 6. Number of LEDs per tray for LUXEON CS CoB.

PART NUMBER	TOTAL UNITS PER TRAY	TOTAL TRAYS PER INNER BOX	TOTAL UNITS PER INNER BOX
L2C6-xxxxxL02x0600	80	2	160
L2C6-xxxxxL02x0900	80	2	160
L2C6-xxxxxL04x0900	80	2	160
L2C6-xxxxxL06x1300	36	2	72
L2C6-xxxxxL08x1500	36	2	72
L2C6-xxxxxL10x1500	36	2	72
L2C6-xxxxxL11x2200	30	2	60
L2C6-xxxxxL13x2200	30	2	60
L2C6-xxxxxL16x2200	30	2	60
L2C6-xxxxxR12x2200	30	2	60
L2C6-xxxxxR18x2200	30	2	60

Tray Dimensions

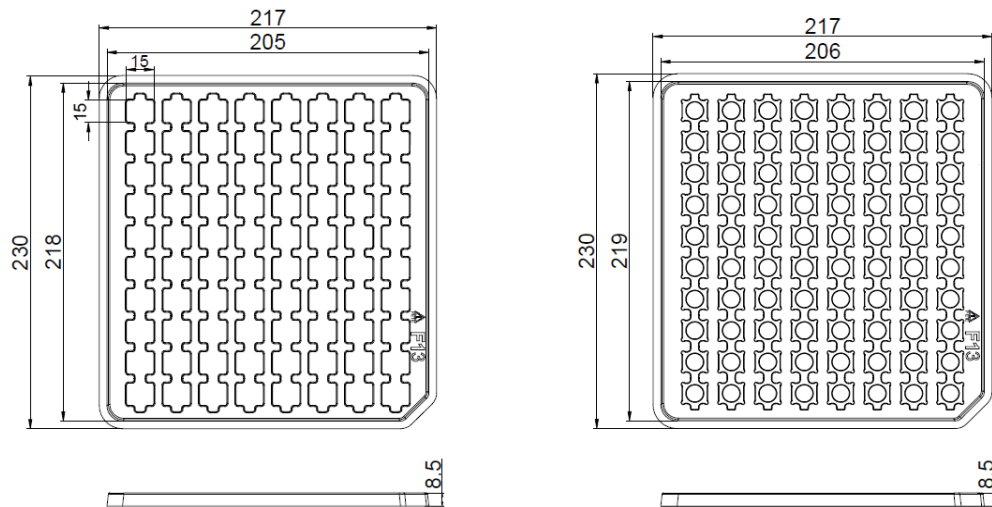

Figure 9a. Tray dimensions for L2C6-xxxxxL02x0600, L2C6-xxxxxL02x0900, L2C6-xxxxxL04x0900.

Notes for Figure 9a:

1. Drawings not to scale.
2. All dimensions are in millimeters.

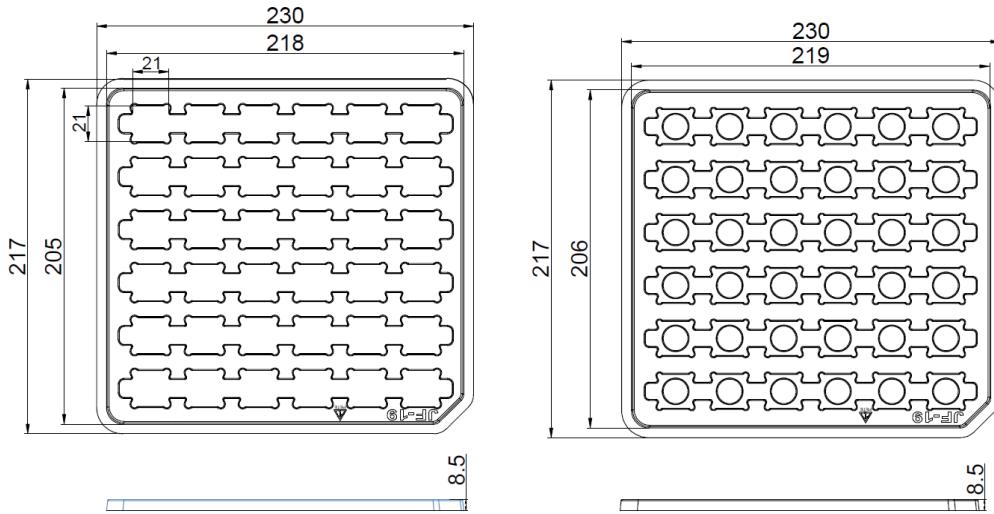

Figure 9b. Tray dimensions for L2C6-xxxxxL06x1300, L2C6-xxxxxL08x1500, L2C6-xxxxxL10x1500.

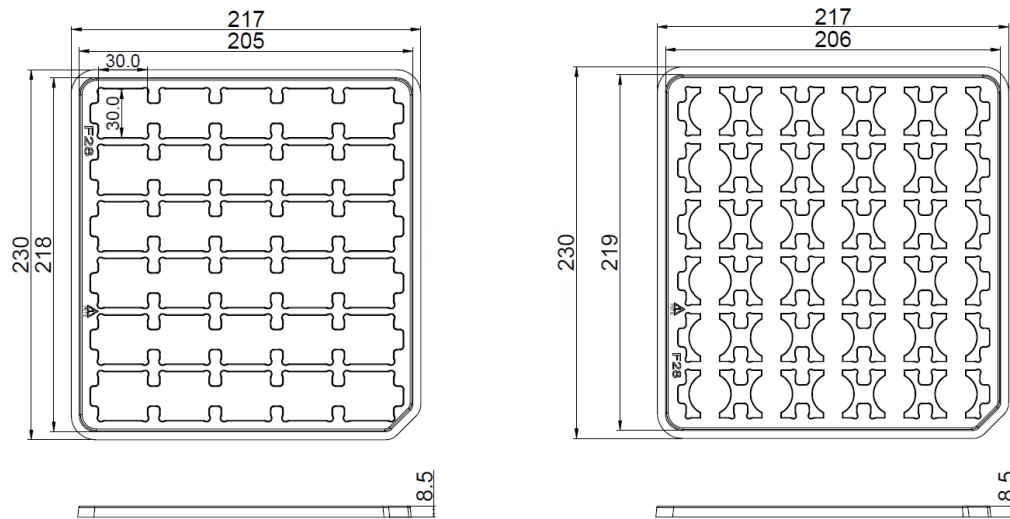

Figure 9c. Tray dimensions for L2C6-xxxxxL06x1300, L2C6-xxxxxL08x1500, L2C6-xxxxxL10x1500.

Notes for Figures 9b and 9c:

1. Drawings not to scale.
2. All dimensions are in millimeters.

Inner Box

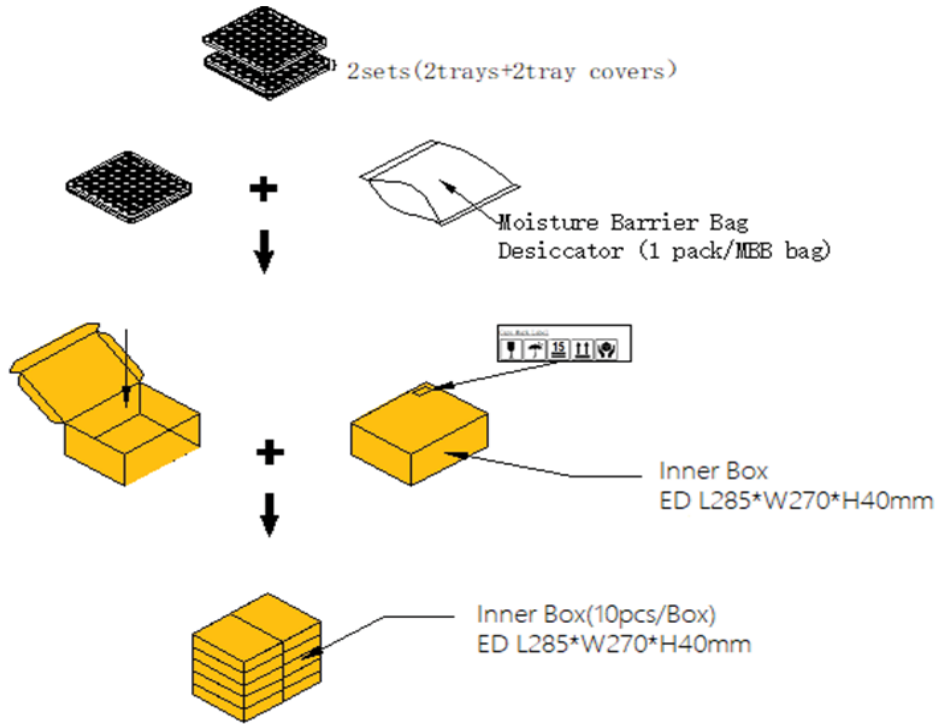

Figure 10. Dimensions for inner box and outer box packaging for LUXEON CS CoB.

Table 7. Inner box information for LUXEON CS CoB.

BOX TYPE	DIMENSIONS (mm)			AVERAGE WEIGHT (160pcs/box)
	H	L	W	
Inner Box	40	285	270	0.376Kg



Figure 11. Example of inner box label and tray label for LUXEON CS CoB.

Notes for Figure 11 – Inner Box Label descriptions for customer use:
Field labels not described are for Lumileds internal use only.

1. Lumileds part number.
2. Number of LED emitters in a box.
3. LED test date in YYWW format.
4. Customer part number for custom requests only.
5. Unique production lot identification number. This number is required for traceability purpose.
6. Product category code.
7. EU regulatory address.

Outer Box

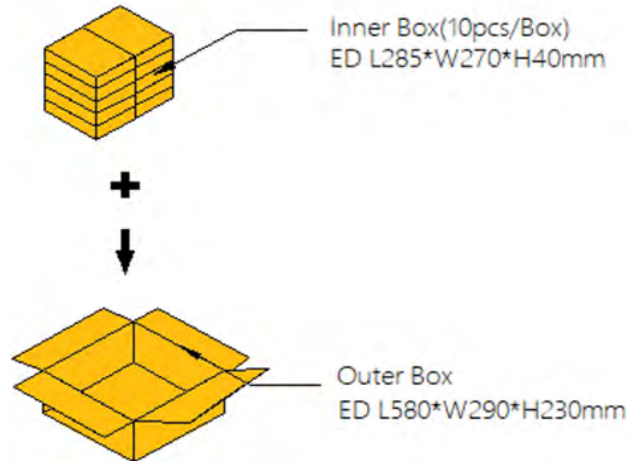

Figure 12. Dimensions for outer box packaging for LUXEON CS CoB.

Table 8. Outer box information for LUXEON CS CoB.

BOX TYPE	DIMENSIONS (mm)			MAXIMUM INNER BOXES PER OUTER BOX	MAXIMUM QUANTITY PER OUTER BOX	AVERAGE WEIGHT (1600pcs/box)
	H	L	W			
Outer Box	230	580	290	10	1600	4.412Kg

Material Number: 927703745301 Loaded Qty: 1600 PCE Label Count: 1/1

(1) Material Desc: L2C6-27902L02A0600

Handling Unit:

(2) Customer Product ID :

Lot ID : 230308G60001	Cat Code: 2S	Quantity: 160
Lot ID : 230308G60002	Cat Code: 2S	Quantity: 160
Lot ID : 230308G60003	Cat Code: 2S	Quantity: 160
Lot ID : 230308G60004	Cat Code: 2S	Quantity: 160
Lot ID : 230308G60005	Cat Code: 2S	Quantity: 160
Lot ID : 230308G60006	Cat Code: 2S	Quantity: 160
Lot ID : 230308G60007	Cat Code: 2S	Quantity: 160
Lot ID : 230308G60008	Cat Code: 2S	Quantity: 160
Lot ID : 230308G60009	Cat Code: 2S	Quantity: 160
Lot ID : 230308G60010	Cat Code: 2S	Quantity: 160

(3)

Figure 13. Example of outer box label for LUXEON CS CoB.

Notes for Figure 13 – Outer Box Label descriptions for customer use:

Field labels not described are for Lumileds internal use only.

1. Lumileds part number.
2. Customer part number for custom requests only.
3. Total number of LED emitters in a shipment box.

About Lumileds

Companies developing automotive, mobile, IoT and illumination lighting applications need a partner who can collaborate with them to push the boundaries of light. With over 100 years of inventions and industry firsts, Lumileds is a global lighting solutions company that helps customers around the world deliver differentiated solutions to gain and maintain a competitive edge. As the inventor of Xenon technology, a pioneer in halogen lighting and the leader in high performance LEDs, Lumileds builds innovation, quality and reliability into its technology, products and every customer engagement. Together with its customers, Lumileds is making the world safer, better and more beautiful—with light.

To learn more about our lighting solutions, visit lumileds.com.



©2023 Lumileds Holding B.V. All rights reserved.
LUXEON is a registered trademark of the Lumileds Holding B.V. in the United States and other countries.
lumileds.com

Neither Lumileds Holding B.V. nor its affiliates shall be liable for any kind of loss of data or any other damages, direct, indirect or consequential, resulting from the use of the provided information and data. Although Lumileds Holding B.V. and/or its affiliates have attempted to provide the most accurate information and data, the materials and services information and data are provided “as is,” and neither Lumileds Holding B.V. nor its affiliates warrants or guarantees the contents and correctness of the provided information and data. Lumileds Holding B.V. and its affiliates reserve the right to make changes without notice. You as user agree to this disclaimer and user agreement with the download or use of the provided materials, information and data. A listing of Lumileds product/patent coverage may be accessed at lumileds.com/patents.