

# ITV9550 30A/45A/60A Series

## Surface Mount



### Agency Approvals

Agency	Agency File Number	Ampere Range
cULUS	E10480	30 A, 45 A
△	TA 50461285	30 A, 45 A

### Thermal Derating Characteristics

Ambient Operating Temperature		25°C	40°C	60°C
Recommend Rated Current (A)	ITV9550 30A Series	34.0	30.0	25.0
	ITV9550 45A Series	49.0	44.5	37.0
	ITV9550 60A Series	67.0	60.0	49.0

### Electrical Characteristics

Part Number	Ordering Code	I <sub>rated</sub> (A)	Cells in Series	V <sub>max</sub> (Vdc)	I <sub>break</sub> (A)	V <sub>OP</sub> (V)	Resistance		Agency Approvals	
							R <sub>heater</sub> (Ω)	R <sub>fuse</sub> (mΩ)	cULUS	△
ITV9550L1230	ITV9550L1230MR	30	3	85	80	8.4 ~ 13.2	3.2 ~ 5.2	0.5 ~ 2.5	X	X
ITV9550L1430	ITV9550L1430MR	30	4	85	80	11.1 ~ 18.4	6.3 ~ 9.3	0.5 ~ 2.5	X	X
ITV9550L1830	ITV9550L1830MR	30	4~5	85	80	10.5 ~ 23.5	4.8 ~ 8.0	0.5 ~ 2.5	X	X
ITV9550L2030	ITV9550L2030MR	30	5	85	80	14.0 ~ 23.4	10.0 ~ 15.0	0.5 ~ 2.5	X	X
ITV9550L3030	ITV9550L3030MR	30	6~7	85	80	20.2 ~ 31.5	18.8 ~ 31.2	0.5 ~ 2.5	X	X
ITV9550L4030	ITV9550L4030MR	30	9~10	85	80	28.0 ~ 46.9	40.0 ~ 60.0	0.5 ~ 2.5	X	X
ITV9550L5030	ITV9550L5030MR	30	12~14	85	80	39.6 ~ 62.0	72.4 ~ 120.6	0.5 ~ 2.5	X	X
ITV9550L1245	ITV9550L1245MR	45	3	85	120	9.8 ~ 13.5	1.9 ~ 3.4	0.4 ~ 2.0	X	X
ITV9550L1445	ITV9550L1445MR	45	4	85	120	13.0 ~ 18.4	3.4 ~ 6.0	0.4 ~ 2.0	X	X
ITV9550L2045	ITV9550L2045MR	45	5	85	120	16.7 ~ 23.5	5.6 ~ 9.9	0.4 ~ 2.0	X	X
ITV9550L3045	ITV9550L3045MR	45	6~7	85	120	22.3 ~ 31.5	10.0 ~ 17.7	0.4 ~ 2.0	X	X
ITV9550L4045	ITV9550L4045MR	45	9~10	85	120	33.0 ~ 46.9	22.0 ~ 38.7	0.4 ~ 2.0	X	X
ITV9550L5045	ITV9550L5045MR	45	12~14	85	120	43.7 ~ 62.0	38.5 ~ 68.0	0.4 ~ 2.0	X	X
ITV9550L1260	ITV9550L1260MR	60	3	80	160	9.6 ~ 13.5	1.83 ~ 3.70	≤ 2.0	X	X
ITV9550L1460	ITV9550L1460MR	60	4	80	160	13.0 ~ 18.4	3.4 ~ 6.7	≤ 2.0	X	X
ITV9550L2060	ITV9550L2060MR	60	5	80	160	16.7 ~ 23.5	5.6 ~ 11.1	≤ 2.0	X	X
ITV9550L3060	ITV9550L3060MR	60	6~7	80	160	22.3 ~ 31.5	10.0 ~ 19.9	≤ 2.0	X	X
ITV9550L4060	ITV9550L4060MR	60	9~10	80	160	33.0 ~ 46.9	22.0 ~ 43.5	≤ 2.0	X	X
ITV9550L5060	ITV9550L5060MR	60	12~14	80	160	43.7 ~ 62.0	38.5 ~ 77.0	≤ 2.0	X	X

Current Capacity	100% x I <sub>rated</sub> , No Melting
Cut Time	200% x I <sub>rated</sub> , < 1 min
Interrupting Current	100A, power on 5 ms, power off 995 ms, 10000 cycles (ITV9550 30A series), No Melting 150A, power on 5 ms, power off 995 ms, 10000 cycles (ITV9550 45A series), No Melting 250A, power on 5 ms, power off 995 ms, 10000 cycles (ITV9550 60A series), No Melting
Over Voltage Operation	In operation voltage range, the fusing time is <1min.

#### Notes:

- I<sub>rated</sub> = Current carrying capacity that is measured at 40°C thermal equilibrium condition
- I<sub>break</sub> = The current that the fuse element is able to interrupt
- V<sub>max</sub> = The maximum voltage that can be cut off by fuse
- V<sub>OP</sub> = Range of operation voltage
- R<sub>heater</sub> = The resistance of the heating element
- R<sub>fuse</sub> = The resistance of the fuse element

Cells in series = Number of battery cells connected in series in the circuit for ITV device to protect.

- Value specified is determined by using the PWB with 6mm\*2oz copper traces, AWG10 covered wire, and 0.6mm glass epoxy PCB for ITV9550 30A Series
- Value specified is determined by using the PWB with 25mm\*2oz copper traces, AWG8 covered wire, and 0.6mm glass epoxy PCB for ITV9550 45A Series
- Value specified is determined by using the PWB with 25mm\*3oz copper traces, AWG6 covered wire, and 0.6mm glass epoxy PCB for ITV9550 60A Series
- Specifications are subject to change without notice.

### Description

ITV9550 Series is a chip type surface mountable device that can protect against both overcurrent and overcharging. It comprises a fuse element to ensure stable operation under normal electrical current and to cut off the current when overcurrent occurs. It also comprises a resistive heating element that could be used in combination with a voltage detecting means, such as IC and FET. When overvoltage is detected, the heating element is electrically excited to generate heat to blow the fuse element to achieve overvoltage protection.

### Features & Benefits

- Halogen Free
- Surface Mount
- Fast response
- Protection for both overcurrent and overcharging

### Applications

- Vacuum cleaner
- Power tools
- E-scooter
- E-bike
- UPS

# ITV9550 30A/45A/60A Series

## Surface Mount

### Cut Time by Heater Operation (ITV9550 30A Series)

Various heater wattage at 25°C ambient temperature

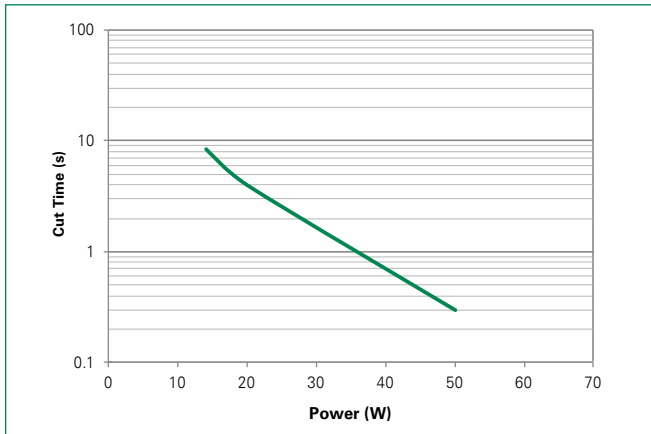

Constant heater wattage at various ambient temperature

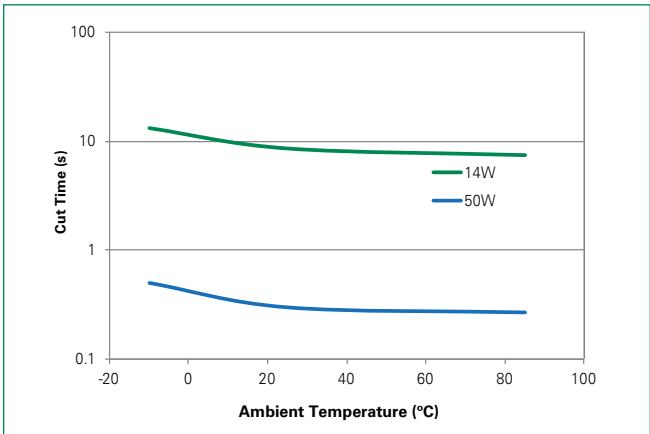

### Cut Time by Heater Operation (ITV9550 45A Series)

Various heater wattage at 25°C ambient temperature

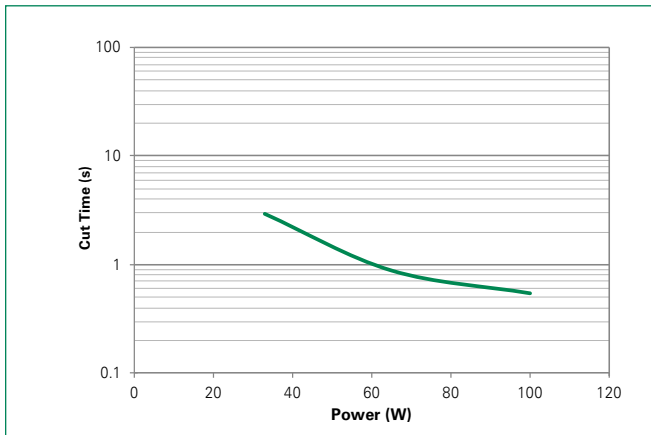

Constant heater wattage at various ambient temperature

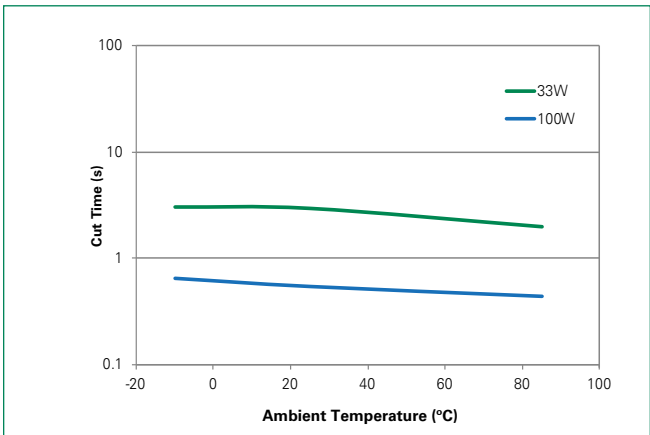

### Cut Time by Heater Operation (ITV9550 60A Series)

Various heater wattage at 25°C ambient temperature

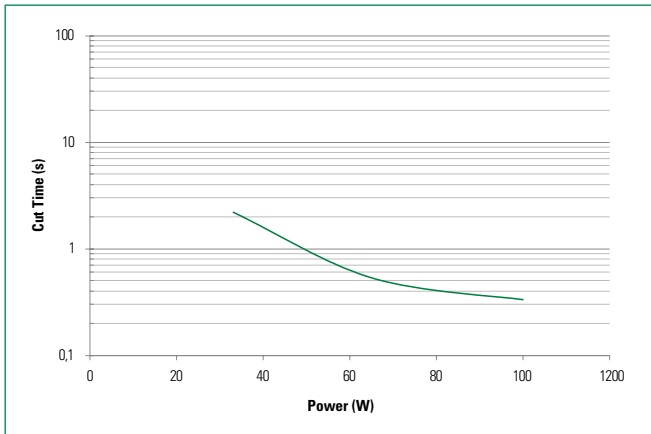

Constant heater wattage at various ambient temperature

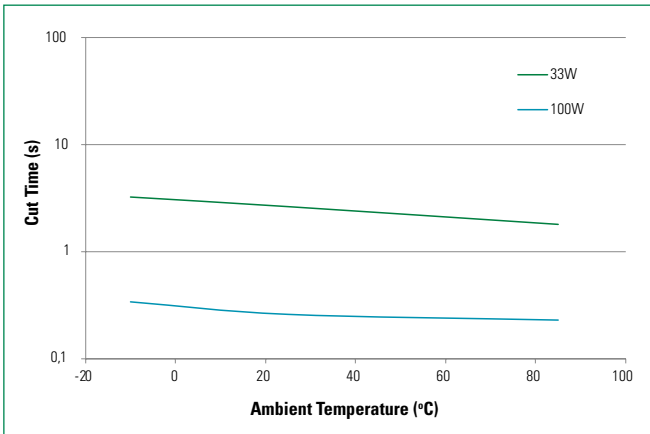

# ITV9550 30A/45A/60A Series

## Surface Mount

### Cut Time by Current Operation (ITV9550 30A Series)

Various interrupting current at 25°C ambient temperature

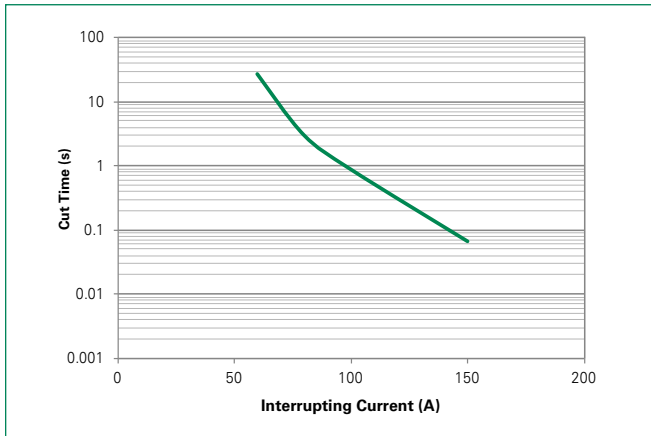

Constant 2x rated current at various ambient temperature

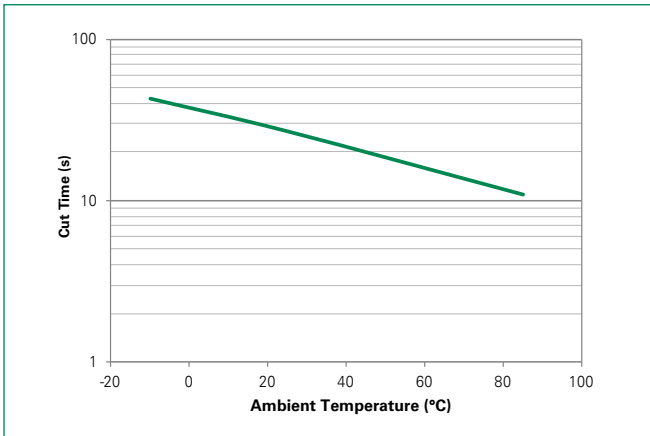

### Cut Time by Current Operation (ITV9550 45A Series)

Various interrupting current at 25°C ambient temperature

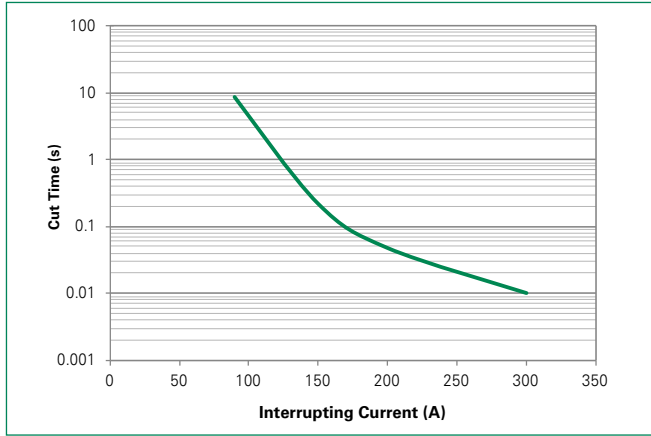

Constant 2x rated current at various ambient temperature

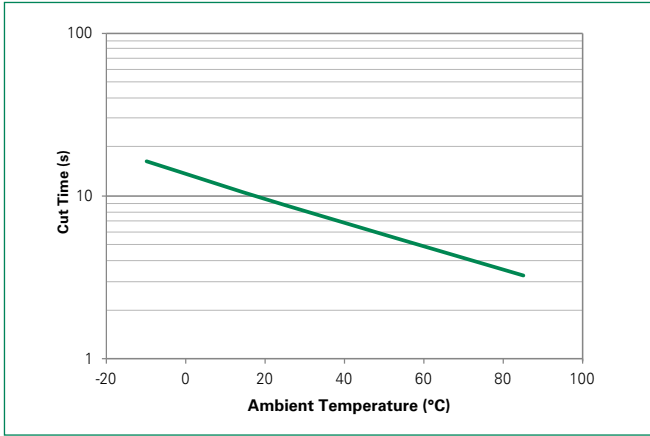

### Cut Time by Current Operation (ITV9550 60A Series)

Various interrupting current at 25°C ambient temperature

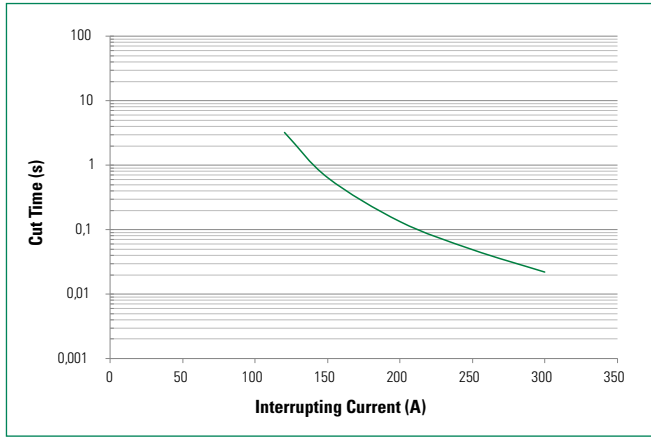

Constant 2x rated current at various ambient temperature

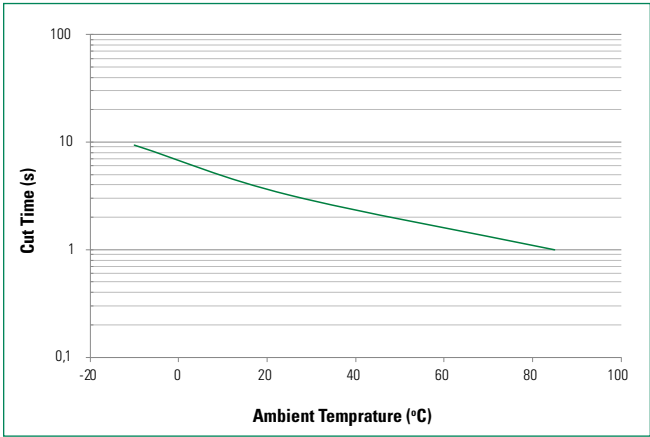

# ITV9550 30A/45A/60A Series

## Surface Mount

### Environmental Specifications

<b>Storage Temperature</b>	0~35°C, ≤70%RH, 3 months after shipment
<b>Operating Temperature</b>	-10°C to +65°C
<b>Hot Passive Aging</b>	100±5°C, 250 hours No structural damage and functional failure
<b>Humidity Aging</b>	60°C±2°C, 90~95% R.H. 250 hours No structural damage and functional failure
<b>Cold Passive Aging</b>	-20±3°C, 500 hours No structural damage and functional failure
<b>Thermal Shock</b>	MIL-STD-202 Method 107G +125°C/-55°C, 100 times No structural damage and functional failure

### Device Circuit

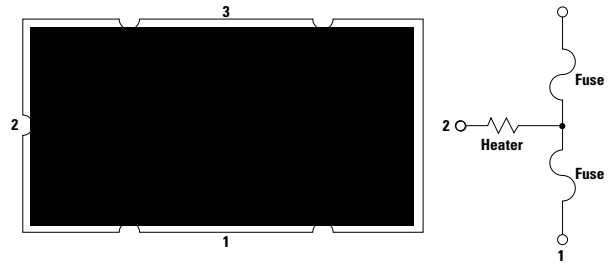

### Physical Dimension (mm)

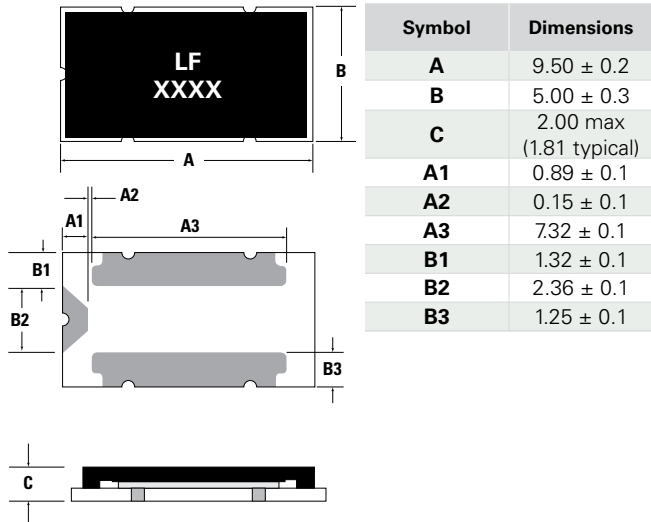

### Board and Solder Layout Recommend (mm)

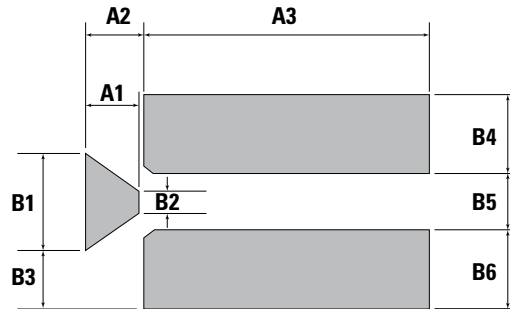

Symbol	Dimensions
<b>A1</b>	1.30 ± 0.1
<b>A2</b>	1.52 ± 0.1
<b>A3</b>	7.60 ± 0.1
<b>B1</b>	3.10 ± 0.1
<b>B2</b>	0.75 ± 0.1
<b>B3</b>	1.95 ± 0.1
<b>B4</b>	2.50 ± 0.1
<b>B5</b>	2.00 ± 0.1
<b>B6</b>	2.50 ± 0.1

# ITV9550 30A/45A/60A Series

## Surface Mount

### Soldering Parameters

<b>Average Ramp-Up Rate (<math>T_{S_{max}}</math> to TP)</b>		3°C/second max.
<b>Preheat</b>	<b>Temperature Min (<math>T_{S_{min}}</math>)</b>	150°C
	<b>Temperature Max (<math>T_{S_{max}}</math>)</b>	200°C
	<b>Time (<math>T_{S_{min}}</math> to <math>T_{S_{max}}</math>)</b>	60-120 seconds
<b>Time maintained above:</b>	<b>Temperature (<math>T_L</math>)</b>	217°C
	<b>Time (<math>t_L</math>)</b>	60-105 seconds
<b>Peak Temperature (<math>T_p</math>)</b>		255°C
<b>Time within 5°C of actual Peak Temperature (<math>t_p</math>)</b>		5 seconds max.
<b>Ramp-Down Rate</b>		6°C/second max.
<b>Time 25°C to Peak Temperature</b>		8 minutes max.

### Physical Specifications

<b>Material</b>	Glass Epoxy PCB
<b>Base Thickness</b>	0.6mm
<b>Copper Thickness</b>	0.07mm for ITV9550 30A&45A Series
	0.105mm for ITV9550 60A Series
<b>Covered Wire</b>	AWG10 (ITV9550 30A Series)
	AWG8 (ITV9550 45A Series)
	AWG6 (ITV9550 60A Series)

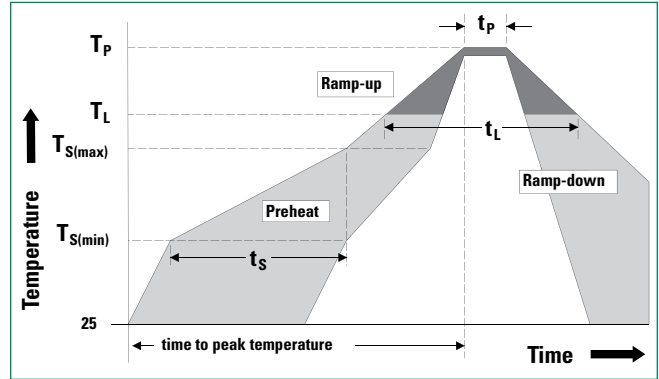

-- All temperature refer to topside of the package, measured on the package body surface  
 -- If reflow temperature exceeds the recommended profile, devices may not meet the performance requirements

# ITV9550 30A/45A/60A Series

## Surface Mount

### Typical Application Circuit Diagram

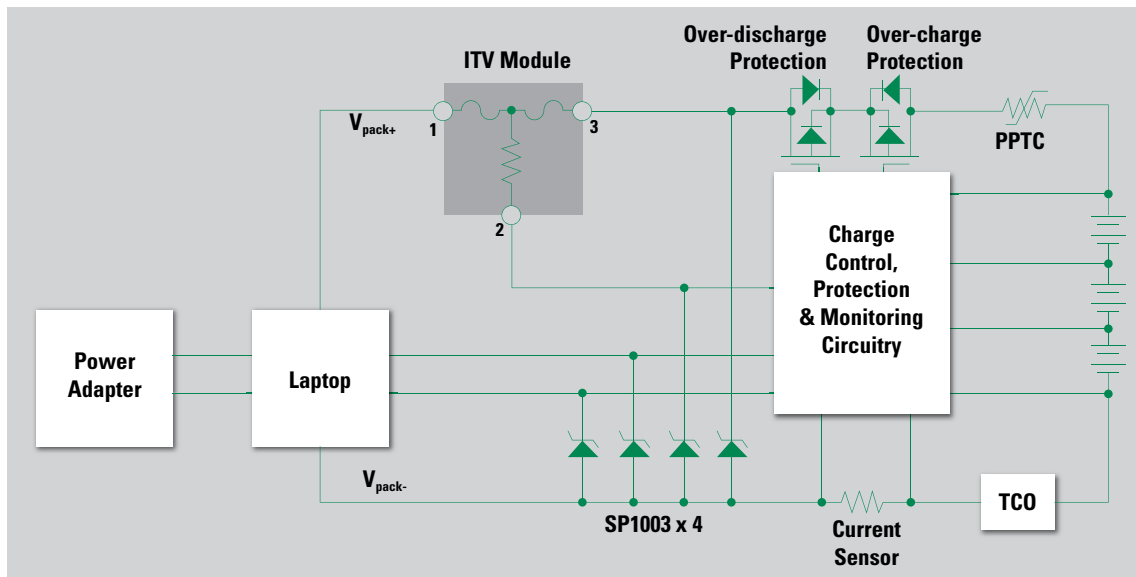

## Installation and Handling Guidelines

- Before and after mounted, the ultrasonic-cleaning or immersion-cleaning must not be done to ITV device. The flux on element would flow, and it would not be satisfied its specification when cleaning is done. In addition, a similar influence happens when the product comes in contact with cleaning solution. These products after cleaning will not be guaranteed.
- Silicone-based oils, oils, solvents, gels, electrolytes, fuels, acids, and similar will adversely affect the properties of ITV devices, and shall not be used or applied.
- Please DO NOT reuse the ITV device removed by the soldering process.
- ITV devices are secondary protection devices and are used solely for sporadic, accidental overcurrent or overtemperature error condition, and shall NOT be used if or when constant or repeated fault conditions (such fault conditions may be caused by, among others, incorrect pin-connection of a connector) or over-extensive trip events may occur.
- Operation over the maximum rating or other forms of improper use may cause failure, arcing, flame and/or other damage to the ITV devices.
- The performance of ITV devices will be adversely affected if they are improperly used under electronic, thermal and/or mechanical procedures and/or conditions non-conformant to those recommended by manufacturer.
- Customers shall be responsible for determining whether it is necessary to have back-up, failsafe and/or fool-proof protection to avoid or minimize damage that may result from extra-ordinary, irregular function or failure of ITV devices.
- There should be minimum of 0.1mm spacing between ITV and surrounding compounds, to maintain the product characteristics and avoid damage other surrounding compounds.
- This product is designed and manufactured only for general-use of electronics devices. We do not recommend that it is used for the applications military, medical and so on which may cause direct damages on life, bodies or properties.

# ITV9550 30A/45A/60A Series

## Surface Mount

### Tape and Reel Specifications (mm)

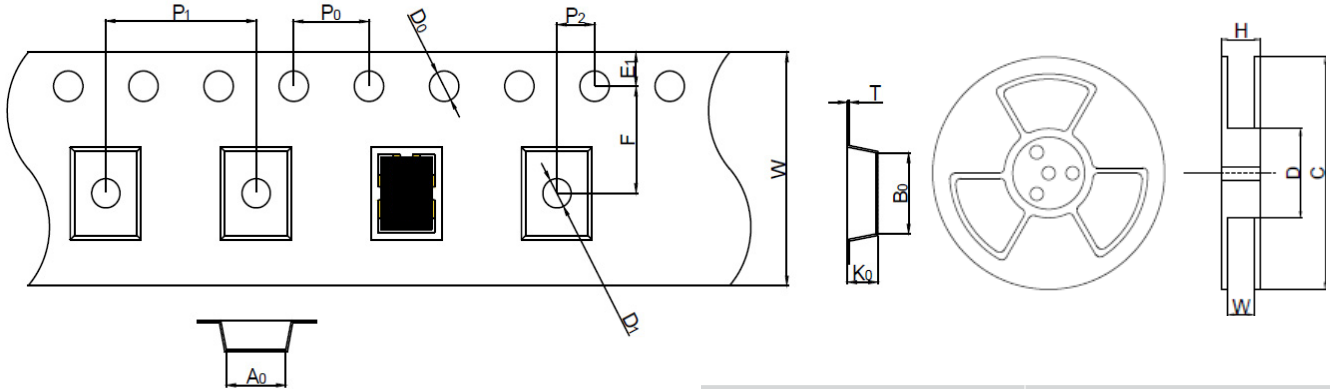

### Part Numbering System

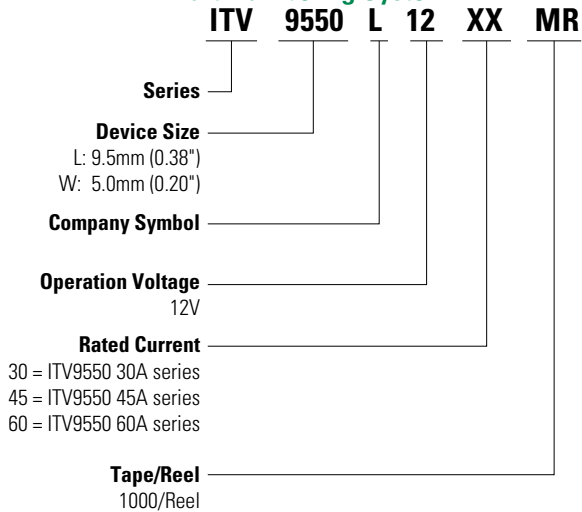

Symbol	Dimension
W	16.0 ± 0.30
F	7.50 ± 0.10
E1	1.75 ± 0.10
D0	1.50 ± 0.10
D1	1.50 ± 0.10
P0	4.00 ± 0.10
P1	8.00 ± 0.10
P2	2.00 ± 0.10
A0	5.40 ± 0.10
B0	9.85 ± 0.10
T	0.30 ± 0.05
K0	2.48 ± 0.10
H	21.4 ± 1.0
W	17.4 ± 1.0
D	Ø99.0 ± 0.5
C	Ø330 ± 1.0

### Packaging

Part Number	Tape and Reel Quantity
ITV9550LXXXX	1,000

### Part Marking System

Marking System for ITV9550 30A&45A Series

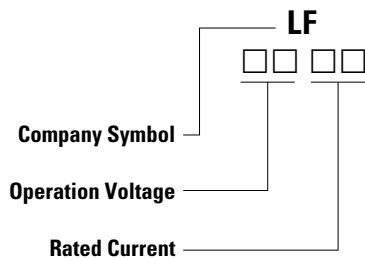

Marking System for ITV9550 60A Series

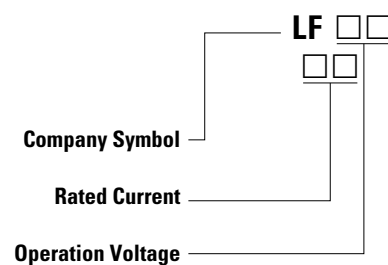

**Disclaimer Notice** - Information furnished is believed to be accurate and reliable. However, users should independently evaluate the suitability of and test each product selected for their own applications. Littelfuse products are not designed for, and may not be used in, all applications. Read complete Disclaimer Notice at [www.littelfuse.com/disclaimer-electronics](http://www.littelfuse.com/disclaimer-electronics).