

For Automotive 300 mA CMOS LDO Regulators

BUxxJA3DG-C series

General Description

The BUxxJA3DG-C series are linear regulators designed as low current consumption products for power supplies in various automotive applications.

These products are designed for up to 6.5 V as an absolute maximum voltage and to operate until 300 mA for the output current with low current consumption 37 μ A (Typ). These can regulate the output with a very high accuracy, ± 2 %. These regulators are therefore an ideal for any applications requiring a low current consumption.

A logical "HIGH" at the EN pin turns on the device, and in the other side, the devices are controlled to disable by a logical "LOW" input to the EN pin.

The devices feature the integrated Over Current Protection to protect the device from a damage caused by a short-circuiting or an overload. These products also integrate Thermal Shutdown Protection to avoid the damage by overheating.

Furthermore, low ESR ceramic capacitors are sufficiently applicable for the phase compensation.

Key Specifications

- Wide Temperature Range (Tj): -40 °C to +150 °C
- Operating Input Range: 1.7 V to 6.0 V
- Low Current Consumption: 37 μ A (Typ)
- Output Current Capability: 300 mA
- High Output Voltage Accuracy: ± 2 %
- Output Voltage: 1.2 V to 3.3 V

Package

SSOP5

W(Typ) x D(Typ) x H(Max)

2.9 mm x 2.8 mm x 1.25 mm



Features

- AEC-Q100 Qualified^(Note 1)
- Output Shutdown Function (EN Function)
- Over Current Protection (OCP)
- Thermal Shutdown Protection (TSD)

^(Note 1) Grade 1

Applications

- Automotive (Power Train, Body ECU, Infotainment, Cluster, etc.)

Typical Application Circuit

- Components Externally Connected
Capacitor: $0.1 \mu\text{F} \leq C_{\text{IN}} (\text{Min}), 0.47 \mu\text{F} \leq C_{\text{OUT}} \leq 47 \mu\text{F}$ ^(Note 2)

^(Note 2) Electrolytic (ESR < 1 Ω), tantalum and ceramic capacitors can be used.

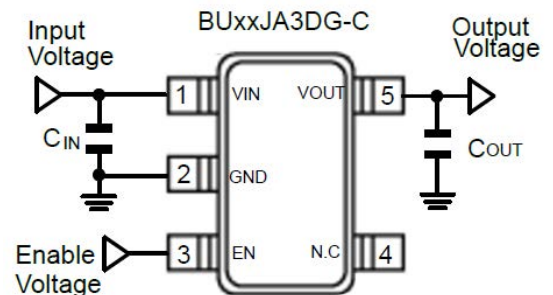

Ordering Information

B	U	x	x	J	A	3	D	G	-	C	y	y
Part Number	Output Voltage 12 : 1.2 V 15 : 1.5 V 18 : 1.8 V 25 : 2.5 V 30 : 3.0 V 33 : 3.3 V			Series Name Output Current Capability: 300 mA Maximum Power Supply Voltage: 6.5 V				Package G : SSOP5	Product Rank C : for Automotive	Packaging and forming specification Embossed tape and reel TR : The pin number 1 is the upper right TL : The pin number 1 is the lower left		

Lineup

Ordering	Output Voltage	Package		Packing Specification
BU12JA3DG-CTR	1.2 V	SSOP5	Reel of 3000	
BU15JA3DG-CTR	1.5 V	SSOP5	Reel of 3000	
BU18JA3DG-CTR	1.8 V	SSOP5	Reel of 3000	
BU25JA3DG-CTR	2.5 V	SSOP5	Reel of 3000	
BU30JA3DG-CTR	3.0 V	SSOP5	Reel of 3000	
BU33JA3DG-CTR	3.3 V	SSOP5	Reel of 3000	
BU12JA3DG-CTL	1.2 V	SSOP5	Reel of 3000	
BU15JA3DG-CTL	1.5 V	SSOP5	Reel of 3000	
BU18JA3DG-CTL	1.8 V	SSOP5	Reel of 3000	
BU25JA3DG-CTL	2.5 V	SSOP5	Reel of 3000	
BU30JA3DG-CTL	3.0 V	SSOP5	Reel of 3000	
BU33JA3DG-CTL	3.3 V	SSOP5	Reel of 3000	

Contents

General Description	1
Features.....	1
Applications	1
Key Specifications	1
Package.....	1
Typical Application Circuit.....	1
Ordering Information.....	2
Lineup	2
Contents	3
Pin Configurations	4
Pin Descriptions.....	4
Block Diagram	5
Description of Blocks	5
Absolute Maximum Ratings	6
Thermal Resistance.....	6
Operating Conditions	7
Electrical Characteristics.....	8
Typical Performance Curves (BU12JA3DG-C)	9
Typical Performance Curves (BU15JA3DG-C)	21
Typical Performance Curves (BU18JA3DG-C)	33
Typical Performance Curves (BU25JA3DG-C)	45
Typical Performance Curves (BU30JA3DG-C)	57
Typical Performance Curves (BU33JA3DG-C)	68
Typical Performance Curves.....	79
Application and Implementation.....	81
Selection of External Components	81
Input Pin Capacitor	81
Output Pin Capacitor	81
Typical Application.....	82
Surge Voltage Protection for Linear Regulators	83
Positive Surge to the Input.....	83
Negative Surge to the Input.....	83
Reverse Voltage Protection for Linear Regulators	83
Protection Against Reverse Input/Output Voltage.....	83
Protection Against Input Reverse Voltage.....	84
Protection Against Reverse Output Voltage when Output Connect to an Inductor	85
Power Dissipation	86
SSOP5	86
Thermal Design	87
I/O Equivalence Circuits.....	88
Operational Notes.....	89
1. Reverse Connection of Power Supply	89
2. Power Supply Lines.....	89
3. Ground Voltage.....	89
4. Ground Wiring Pattern.....	89
5. Operating Conditions.....	89
6. Inrush Current.....	89
7. Thermal Consideration	89
8. Testing on Application Boards	89
9. Inter-pin Short and Mounting Errors	89
10. Unused Input Pins	89
11. Regarding the Input Pin of the IC	90
12. Ceramic Capacitor.....	90
13. Thermal Shutdown Protection Circuit (TSD).....	90
14. Over Current Protection Circuit (OCP)	90
15. Enable Pin.....	90
Marking Diagram	91
Physical Dimension and Packing Information	92
Revision History.....	93

Pin Configurations

SSOP5 (TOP VIEW)

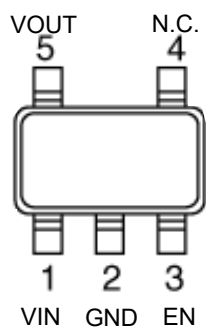

Pin Descriptions

Pin No.	Pin Name	Pin Function	Descriptions
1	VIN	Input Voltage Pin	Set a capacitor with a capacitance of 0.1 μF (Min) or higher between the VIN pin and GND. The selecting method is described in Selection of External Components . If the inductance of power supply line is high, please adjust input capacitor value.
2	GND	Ground Pin	Ground.
3	EN	Enable Input Pin	A logical "HIGH" ($V_{\text{ENH}} \geq 1.1 \text{ V}$) at the EN pin enables the device and "LOW" ($V_{\text{ENL}} \leq 0.5 \text{ V}$) at the EN pin disables the device.
4	N.C.	-	This pin is not connected to the chip. It can keep open or it's also possible to connect to GND.
5	VOUT	Output Voltage Pin	Set a capacitor with a capacitance of 0.47 μF (Min) or higher between the VOUT pin and GND. The selecting method is described in Selection of External Components .

Block Diagram

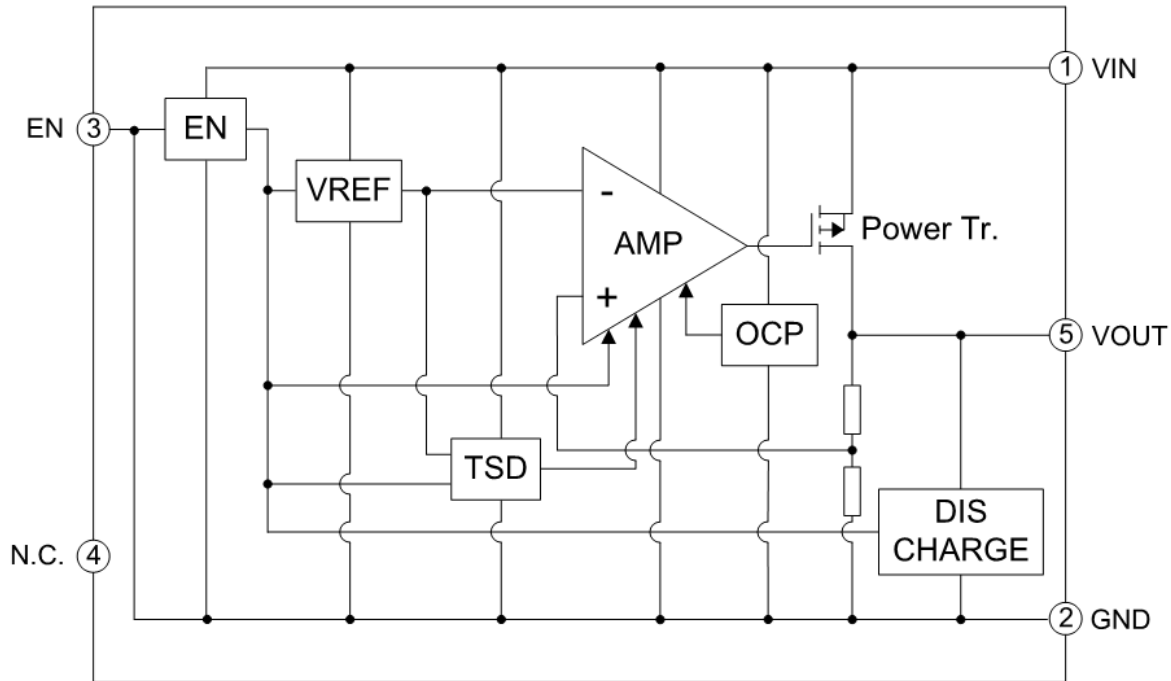

Description of Blocks

Block Name	Function	Description of Blocks
EN	Enable Input	A logical "HIGH" ($V_{ENH} \geq 1.1 \text{ V}$) at the EN pin enables the device and "LOW" ($V_{ENL} \leq 0.5 \text{ V}$) at the EN pin disables the device.
TSD	Thermal Shutdown Protection	In case maximum power dissipation exceeds or the ambient temperature is higher than the Maximum Junction Temperature, overheating causes the chip temperature (T_j) to rise. The TSD protection circuit detects this and forces the gate of output MOSFET(Power Tr.) to turn off in order to protect the device from overheating. When the junction temperature decreases to low, the output turns on automatically.
VREF	Reference Voltage	Generate the reference voltage.
AMP	Error Amplifier	The error amplifier amplifies the difference between the feedback voltage of the output voltage and the reference voltage.
OCP	Over Current Protection	If the output current increases higher than the maximum output current, it is limited by Over Current Protection to protect the device from damage caused by an over current. While this block is operating, the output voltage may decrease because the output current is limited. If an abnormal state is removed and the output current value returns to normal, the output voltage also returns to normal state.
DISCHARGE	Output Discharge Function	Output pin is discharged by the internal resistance (Typ: 40 Ω) when EN = "LOW" input.

Absolute Maximum Ratings

Parameter	Symbol	Ratings	Unit
VIN Pin Voltage ^(Note 1)	V _{IN}	-0.3 to +6.5	V
EN Pin Voltage ^(Note 2)	V _{EN}	-0.3 to +6.5	V
VOUT Pin Voltage	V _{OUT}	-0.3 to +6.5 (≤ V _{IN} + 0.3)	V
Junction Temperature Range	T _j	-40 to +150	°C
Storage Temperature Range	T _{stg}	-55 to +150	°C
Maximum Junction Temperature	T _{jmax}	150	°C
ESD Withstand Voltage (HBM) ^(Note 3)	V _{ESD_HBM}	±2000	V
ESD Withstand Voltage (CDM) ^(Note 4)	V _{ESD_CDM}	±750	V

Caution 1: Operating the IC over the absolute maximum ratings may damage the IC. The damage can either be a short circuit between pins or an open circuit between pins and the internal circuitry. Therefore, it is important to consider circuit protection measures, such as adding a fuse, in case the IC is operated over the absolute maximum ratings.

Caution 2: Should by any chance the maximum junction temperature rating be exceeded the rise in temperature of the chip may result in deterioration of the properties of the chip. In case of exceeding this absolute maximum rating, design a PCB with thermal resistance and power dissipation taken into consideration by increasing board size and copper area so as not to exceed the maximum junction temperature rating.

(Note 1) Do not exceed T_{jmax}.

(Note 2) The start-up orders of power supply (V_{IN}) and the V_{EN} do not influence if the voltage is within the operation power supply voltage range.

(Note 3) ESD susceptibility Human Body Model "HBM"; base on ANSI/ESDA/JEDEC JS001 (1.5 kΩ, 100 pF).

(Note 4) ESD susceptibility Charged Device Model "CDM"; base on JEDEC JESD22-C101.

Thermal Resistance^(Note 5)

Parameter	Symbol	Thermal Resistance (Typ)		Unit
		1s ^(Note 7)	2s2p ^(Note 8)	
SSOP5				
Junction to Ambient	θ _{JA}	264.4	135.7	°C/W
Junction to Top Characterization Parameter ^(Note 6)	Ψ _{JT}	34	27	°C/W

(Note 5) Based on JESD51-2A(Still-Air). Using BUxxJA3DG-C.

(Note 6) The thermal characterization parameter to report the difference between junction temperature and the temperature at the top center of the outside surface of the component package.

(Note 7) Using a PCB board based on JESD51-3.

(Note 8) Using a PCB board based on JESD51-7.

Layer Number of Measurement Board	Material	Board Size
Single	FR-4	114.3 mm x 76.2 mm x 1.57 mmt

Top	
Copper Pattern	Thickness
Footprints and Traces	70 μm

Layer Number of Measurement Board	Material	Board Size
4 Layers	FR-4	114.3 mm x 76.2 mm x 1.6 mmt

Top		2 Internal Layers		Bottom	
Copper Pattern	Thickness	Copper Pattern	Thickness	Copper Pattern	Thickness
Footprints and Traces	70 μm	74.2 mm x 74.2 mm	35 μm	74.2 mm x 74.2 mm	70 μm

Operating Conditions ($-40\text{ °C} \leq T_j \leq +150\text{ °C}$)

Parameter	Symbol	Min	Max	Unit
VIN Input Voltage ^(Note 1)	V _{IN}	V _{OUT} (Max) + ΔVd (Max)	6.0	V
Start-Up Voltage	V _{IN Start-Up}	1.7	-	V
Enable Input Voltage	V _{EN}	0	6.0	V
Output Current	I _{OUT}	0	300	mA
Input Capacitor ^(Note 2)	C _{IN}	0.1	-	μF
Output Capacitor ^(Note 3)	C _{OUT}	0.47	47	μF
Output Capacitor Equivalent Series Resistance	ESR(C _{OUT})	-	1	Ω
Operating Temperature	T _a	-40	+125	°C

(Note 1) Minimum Input Voltage must be 1.7 V or more.

Please consider that the output voltage would be dropped (Dropout voltage ΔVd) depending on the output current.

(Note 2) If the inductance of power supply line is high, please adjust input capacitor value in order to lower the input impedance.

A lower input impedance can bring out the ideal characteristic of IC as much as possible.

It also has the effect of preventing the voltage-drop at the input line.

(Note 3) Set capacitor value which do not fall below the minimum value. This value needs to consider the temperature characteristics and DC device characteristics.

Electrical Characteristics

Unless otherwise specified, $T_j = -40\text{ }^\circ\text{C}$ to $+150\text{ }^\circ\text{C}$, $V_{IN} = V_{OUT} + 1.0\text{ V}$ ^(Note 1), $I_{OUT} = 0\text{ mA}$, $V_{EN} = 1.5\text{ V}$

Typical values are defined at $T_j = 25\text{ }^\circ\text{C}$, $V_{IN} = V_{OUT} + 1.0\text{ V}$ ^(Note 1)

Parameter	Symbol	Limit			Unit	Conditions
		MIN	TYP	MAX		
Shutdown Current	I_{SD}	-	-	2	μA	$V_{EN} = 0\text{ V}$, $T_j = -40\text{ }^\circ\text{C}$ to $+85\text{ }^\circ\text{C}$
		-	-	10	μA	$V_{EN} = 0\text{ V}$, $T_j = -40\text{ }^\circ\text{C}$ to $+125\text{ }^\circ\text{C}$
Current Consumption	I_{CC}	-	37	55	μA	$I_{OUT} \leq 500\text{ }\mu\text{A}$, $V_{IN} \leq 5.5\text{ V}$ $T_j = +25\text{ }^\circ\text{C}$
		-	37	62	μA	$I_{OUT} \leq 500\text{ }\mu\text{A}$, $V_{IN} \leq 5.5\text{ V}$ $T_j = -40\text{ }^\circ\text{C}$ to $+85\text{ }^\circ\text{C}$
		-	37	80	μA	$I_{OUT} \leq 500\text{ }\mu\text{A}$ $T_j = -40\text{ }^\circ\text{C}$ to $+125\text{ }^\circ\text{C}$
Output Voltage	V_{OUT}	$V_{OUT} \times 0.98$	V_{OUT}	$V_{OUT} \times 1.02$	V	$I_{OUT} = 1\text{ mA}$ to 300 mA $V_{OUT} > 2.5\text{ V}$ $V_{IN} = V_{OUT} + 0.5\text{ V}$ to 5.5 V $V_{OUT} \leq 2.5\text{ V}$ $V_{IN} = 3.0\text{ V}$ to 5.5 V
Line Regulation	Reg.I	-	4	8	mV	$I_{OUT} = 10\text{ mA}$ $V_{OUT} \leq 2.5\text{ V}$ $V_{IN} = 3.0\text{ V}$ to 5.5 V
		-	6	12	mV	$I_{OUT} = 10\text{ mA}$ $V_{OUT} > 2.5\text{ V}$ $V_{IN} = V_{OUT} + 0.5\text{ V}$ to 5.5 V
Load Regulation	Reg.L	-	-	15	mV	$I_{OUT} = 1\text{ mA}$ to 300 mA
Dropout Voltage ^(Note 2)	ΔV_d	-	-	500	mV	$I_{OUT} = 300\text{ mA}$, $V_{OUT} = 1.2\text{ V}$
		-	-	365	mV	$I_{OUT} = 300\text{ mA}$, $V_{OUT} = 1.5\text{ V}$
		-	-	330	mV	$I_{OUT} = 300\text{ mA}$, $V_{OUT} = 1.8\text{ V}$
		-	-	240	mV	$I_{OUT} = 300\text{ mA}$, $V_{OUT} = 2.5\text{ V}$
		-	-	220	mV	$I_{OUT} = 300\text{ mA}$, $V_{OUT} = 3.0\text{ V}$
		-	-	200	mV	$I_{OUT} = 300\text{ mA}$, $V_{OUT} = 3.3\text{ V}$
Maximum Output Current	I_{OMAX}	300	-	-	mA	$V_{IN} > V_{OUT}(\text{Max}) + \Delta V_d(\text{Max})$
Over Current Protection ^(Note 3)	$I_{OUT(OC)}$	-	450	600	mA	Applied $V_{OUT} \times 0.95$ for the V_{OUT} Pin
Ripple Rejection Ratio	R.R.	-	60	-	dB	$V_{RR} = 1\text{ V}_{p-p}$, $f_{RR} = 1\text{ kHz}$ $I_{OUT} = 300\text{ mA}$, $V_{IN} = 5\text{ V}$
Output Noise ^(Note 3)	V_{NOISE}	-	30	-	μV_{rms}	$BW = 10\text{ Hz}$ to 100 kHz $V_{OUT} = 1.2\text{ V}$
Discharge Resistor	R_{DSC}	25	40	75	Ω	$V_{IN} = 4.0\text{ V}$, $V_{EN} = 0\text{ V}$ $V_{OUT} = 4.0\text{ V}$
Enable HIGH Voltage	V_{ENH}	1.1	-	6.0	V	-
Enable LOW Voltage	V_{ENL}	0	-	0.5	V	-
Enable Bias Current	I_{EN}	-	-	4	μA	-
Thermal Shutdown Temperature ^(Note 3)	T_{TSD}	155	175	195	$^\circ\text{C}$	-
Thermal Shutdown Hysteresis ^(Note 3)	T_{TSDHYS}	-	15	-	$^\circ\text{C}$	-

(Note 1) $V_{IN} = 3.0\text{ V}$ for $V_{OUT} < 2.5\text{ V}$.

(Note 2) $V_{IN} = V_{OUT} \times 0.98$. For outputs below 1.7 V , dropout voltage means the minimum input-to-output differential voltage with $I_{OUT} = 300\text{ mA}$ for regulate.

(Note 3) Not measured.

Typical Performance Curves (BU12JA3DG-C)

Unless otherwise specified, $V_{IN} = 3.0\text{ V}$, $V_{EN} = 1.5\text{ V}$, $C_{IN} = 0.1\text{ }\mu\text{F}$, $C_{OUT} = 1.0\text{ }\mu\text{F}$

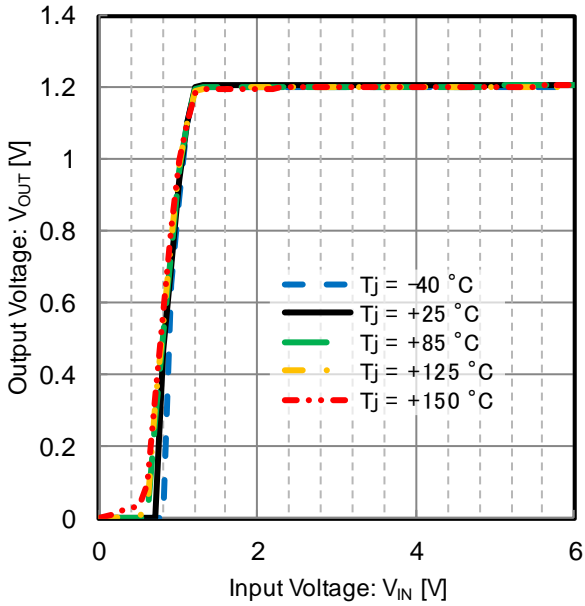

Figure 1. Output Voltage vs Input Voltage
 $V_{OUT} = 1.2\text{ V}$

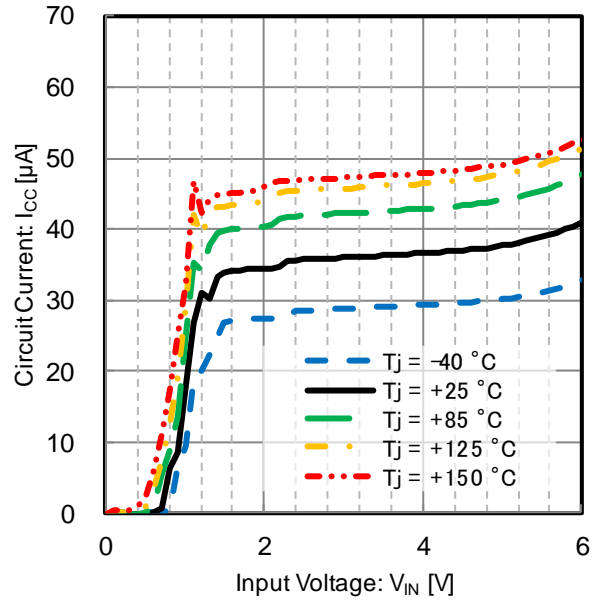

Figure 2. Circuit Current vs Input Voltage
 $V_{OUT} = 1.2\text{ V}$

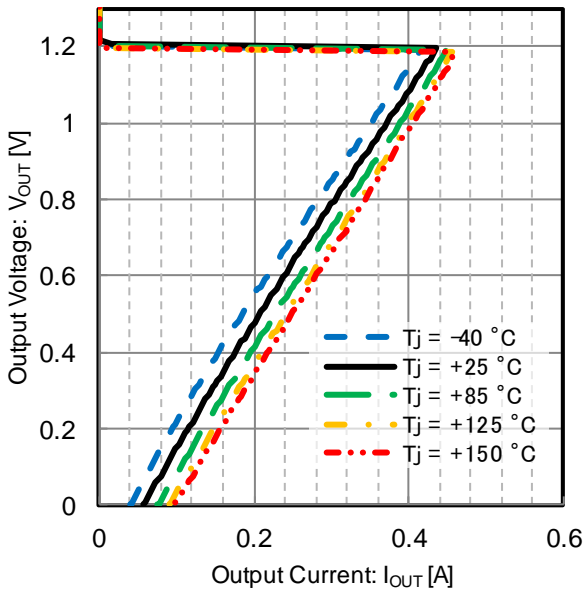

Figure 3. Output Current Limit
 $V_{OUT} = 1.2\text{ V}$

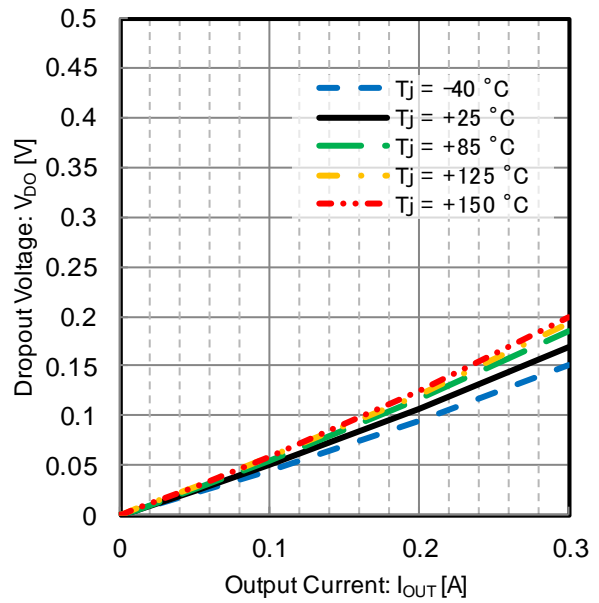

Figure 4. Dropout Voltage vs Output Current
 $V_{IN} = 1.7\text{ V}$, $V_{OUT} = 1.2\text{ V}$

Typical Performance Curves (BU12JA3DG-C) - continued

Unless otherwise specified, $V_{IN} = 3.0\text{ V}$, $V_{EN} = 1.5\text{ V}$, $C_{IN} = 0.1\text{ }\mu\text{F}$, $C_{OUT} = 1.0\text{ }\mu\text{F}$

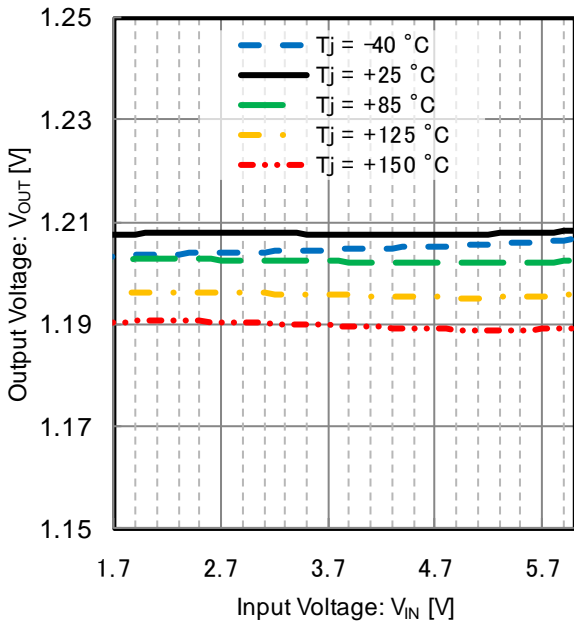

Figure 5. Line Regulation
 $V_{OUT} = 1.2\text{ V}$, $I_{OUT} = 50\text{ mA}$

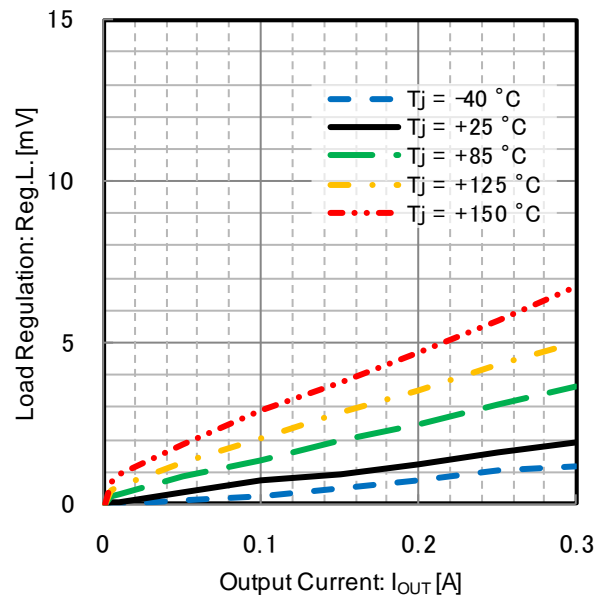

Figure 6. Load Regulation
 $V_{OUT} = 1.2\text{ V}$, $I_{OUT} = 1\text{ mA}$ to 300 mA

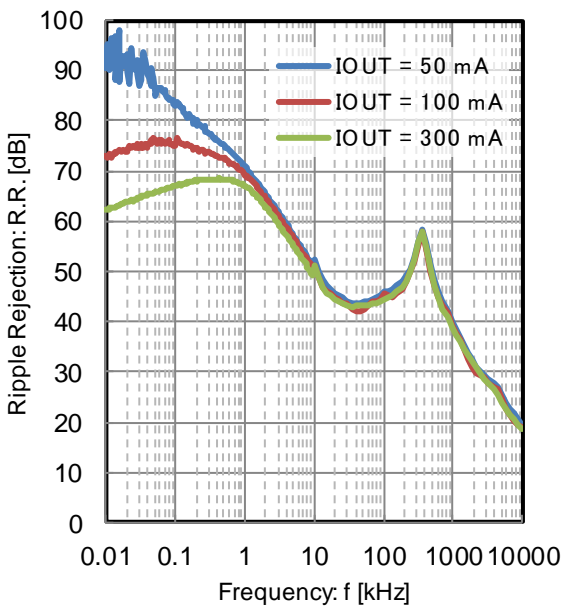

Figure 7. PSRR vs Frequency and Output Current
 $C_{IN} = 0\text{ }\mu\text{F}$, $C_{OUT} = 10\text{ }\mu\text{F}$
 $V_{OUT} = 1.2\text{ V}$

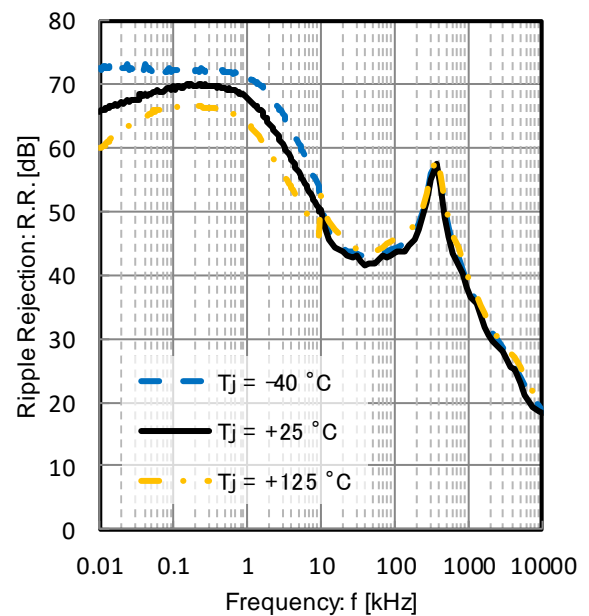

Figure 8. PSRR vs Frequency and Temperature
 $C_{IN} = 0\text{ }\mu\text{F}$, $C_{OUT} = 10\text{ }\mu\text{F}$
 $V_{IN} = 5\text{ V}$, $V_{OUT} = 1.2\text{ V}$, $I_{OUT} = 300\text{ mA}$

Typical Performance Curves (BU12JA3DG-C) - continued

Unless otherwise specified, $V_{IN} = 3.0\text{ V}$, $V_{EN} = 1.5\text{ V}$, $C_{IN} = 0.1\text{ }\mu\text{F}$, $C_{OUT} = 1.0\text{ }\mu\text{F}$

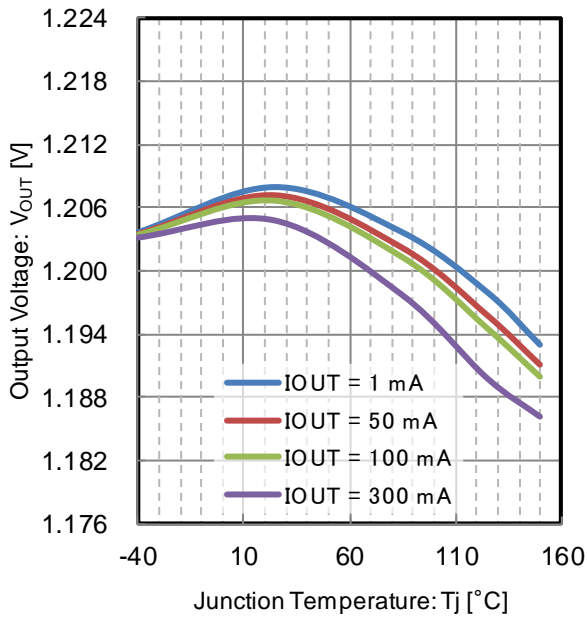

Figure 9. Output Voltage vs Junction temperature
 $V_{OUT} = 1.2\text{ V}$

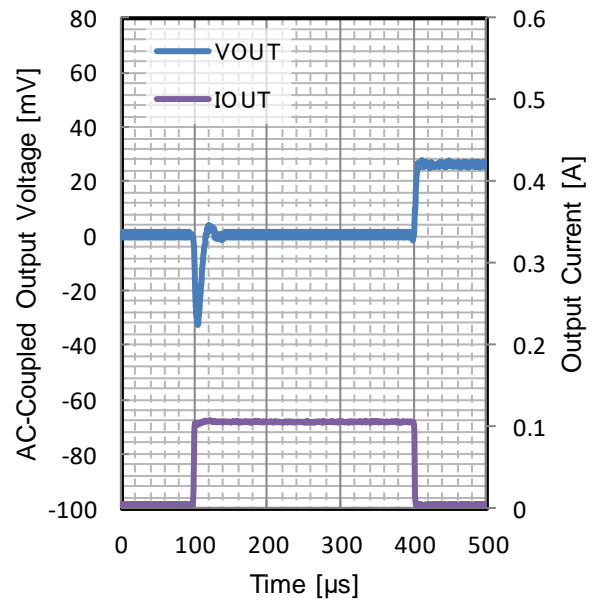

Figure 10. Load Transient
 $V_{OUT} = 1.2\text{ V}$
 $t_R = t_F = 1\text{ }\mu\text{s}$, $I_{OUT} = 0\text{ mA to }100\text{ mA}$, $C_{OUT} = 10\text{ }\mu\text{F}$
 $T_j = -40\text{ }^\circ\text{C}$

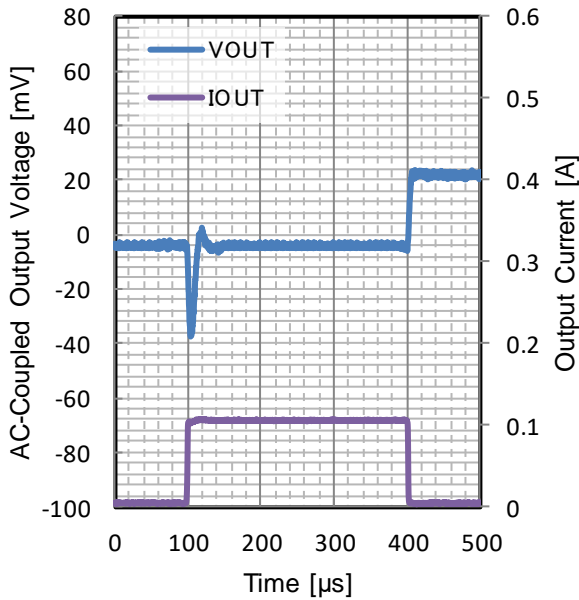

Figure 11. Load Transient
 $V_{OUT} = 1.2\text{ V}$
 $t_R = t_F = 1\text{ }\mu\text{s}$, $I_{OUT} = 0\text{ mA to }100\text{ mA}$, $C_{OUT} = 10\text{ }\mu\text{F}$
 $T_j = 25\text{ }^\circ\text{C}$

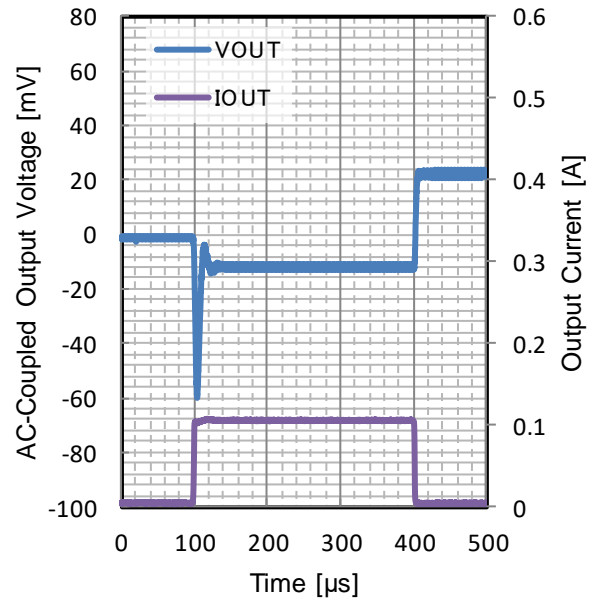

Figure 12. Load Transient
 $V_{OUT} = 1.2\text{ V}$
 $t_R = t_F = 1\text{ }\mu\text{s}$, $I_{OUT} = 0\text{ mA to }100\text{ mA}$, $C_{OUT} = 10\text{ }\mu\text{F}$
 $T_j = 150\text{ }^\circ\text{C}$

Typical Performance Curves (BU12JA3DG-C) - continued

Unless otherwise specified, $V_{IN} = 3.0\text{ V}$, $V_{EN} = 1.5\text{ V}$, $C_{IN} = 0.1\text{ }\mu\text{F}$, $C_{OUT} = 1.0\text{ }\mu\text{F}$

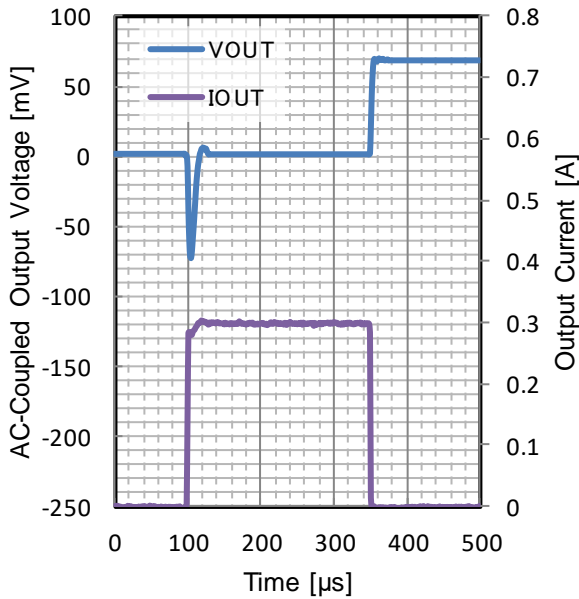

Figure 13. Load Transient

$V_{OUT} = 1.2\text{ V}$

$t_R = t_F = 1\text{ }\mu\text{s}$, $I_{OUT} = 0\text{ mA to }300\text{ mA}$, $C_{OUT} = 10\text{ }\mu\text{F}$
 $T_j = -40\text{ }^\circ\text{C}$

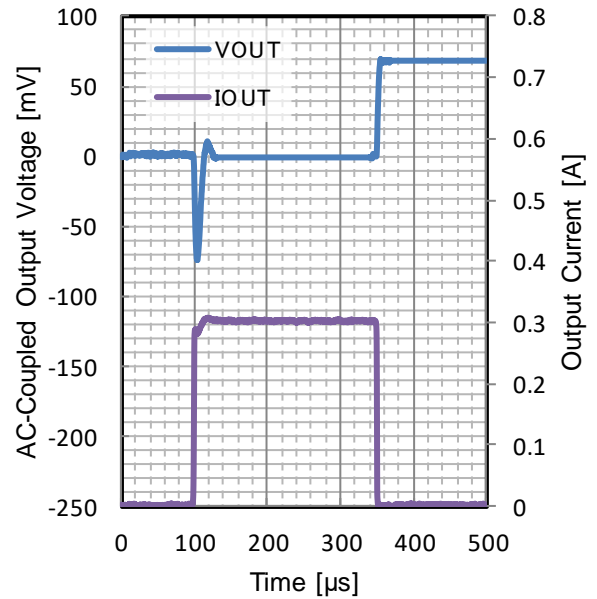

Figure 14. Load Transient

$V_{OUT} = 1.2\text{ V}$

$t_R = t_F = 1\text{ }\mu\text{s}$, $I_{OUT} = 0\text{ mA to }300\text{ mA}$, $C_{OUT} = 10\text{ }\mu\text{F}$
 $T_j = 25\text{ }^\circ\text{C}$

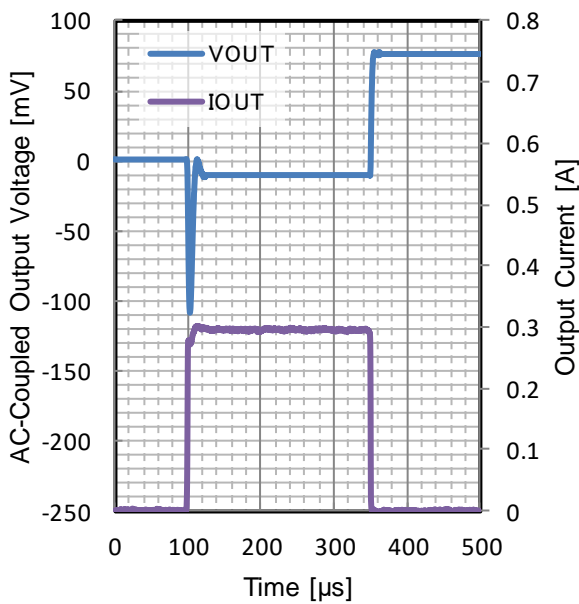

Figure 15. Load Transient

$V_{OUT} = 1.2\text{ V}$

$t_R = t_F = 1\text{ }\mu\text{s}$, $I_{OUT} = 0\text{ mA to }300\text{ mA}$, $C_{OUT} = 10\text{ }\mu\text{F}$
 $T_j = 150\text{ }^\circ\text{C}$

Typical Performance Curves (BU12JA3DG-C) - continued

Unless otherwise specified, $V_{IN} = 3.0\text{ V}$, $V_{EN} = 1.5\text{ V}$, $C_{IN} = 0.1\text{ }\mu\text{F}$, $C_{OUT} = 1.0\text{ }\mu\text{F}$

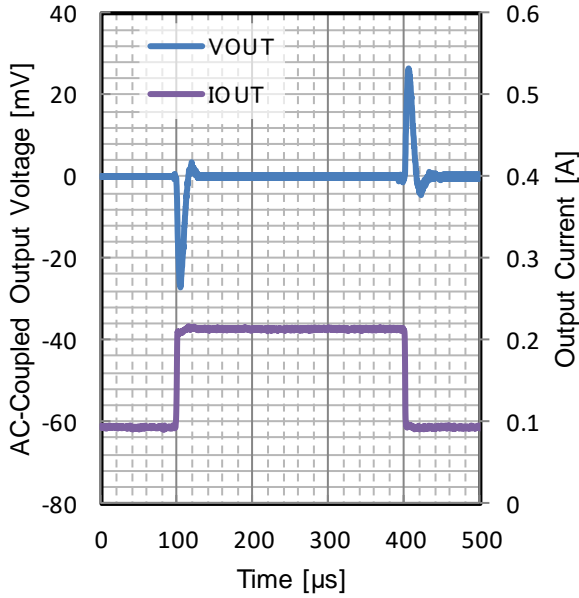

Figure 16. Load Transient

$V_{OUT} = 1.2\text{ V}$

$t_r = t_f = 1\text{ }\mu\text{s}$, $I_{OUT} = 90\text{ mA to }210\text{ mA}$, $C_{OUT} = 10\text{ }\mu\text{F}$
 $T_j = -40\text{ }^\circ\text{C}$

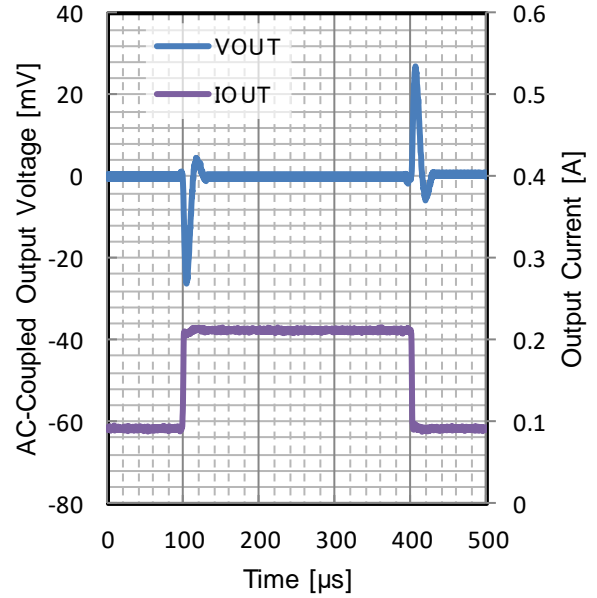

Figure 17. Load Transient

$V_{OUT} = 1.2\text{ V}$

$t_r = t_f = 1\text{ }\mu\text{s}$, $I_{OUT} = 90\text{ mA to }210\text{ mA}$, $C_{OUT} = 10\text{ }\mu\text{F}$
 $T_j = 25\text{ }^\circ\text{C}$

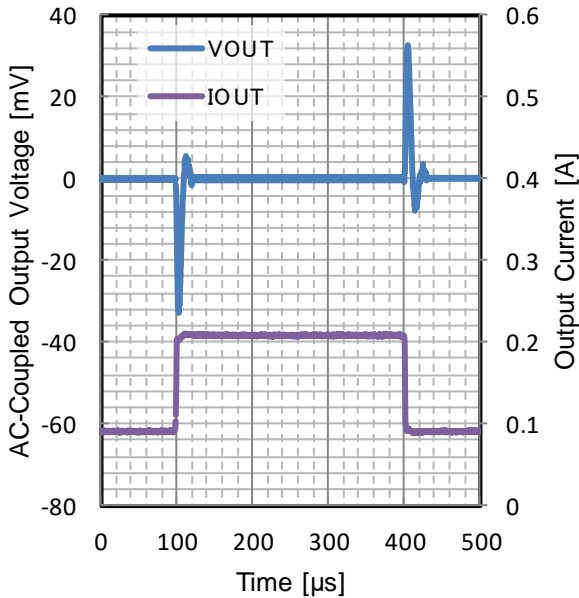

Figure 18. Load Transient

$V_{OUT} = 1.2\text{ V}$

$t_r = t_f = 1\text{ }\mu\text{s}$, $I_{OUT} = 90\text{ mA to }210\text{ mA}$, $C_{OUT} = 10\text{ }\mu\text{F}$
 $T_j = 150\text{ }^\circ\text{C}$

Typical Performance Curves (BU12JA3DG-C) - continued

Unless otherwise specified, $V_{IN} = 3.0\text{ V}$, $V_{EN} = 1.5\text{ V}$, $C_{IN} = 0.1\text{ }\mu\text{F}$, $C_{OUT} = 1.0\text{ }\mu\text{F}$

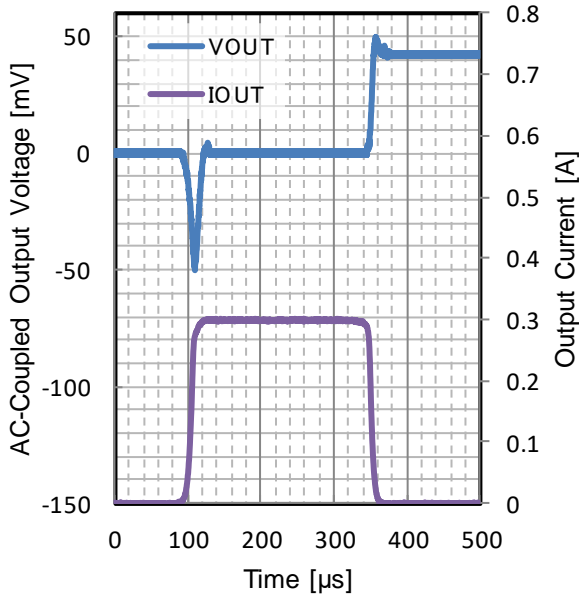

Figure 19. Load Transient

$V_{OUT} = 1.2\text{ V}$

$t_R = t_F = 10\text{ }\mu\text{s}$, $I_{OUT} = 0\text{ mA to }300\text{ mA}$, $C_{OUT} = 10\text{ }\mu\text{F}$
 $T_j = -40\text{ }^\circ\text{C}$

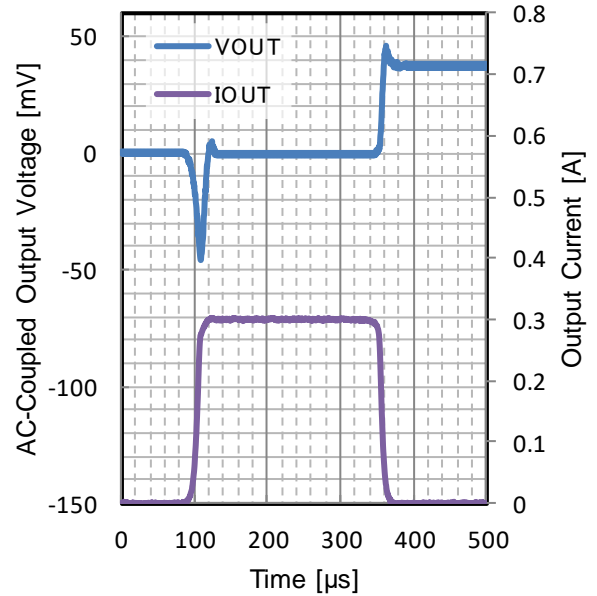

Figure 20. Load Transient

$V_{OUT} = 1.2\text{ V}$

$t_R = t_F = 10\text{ }\mu\text{s}$, $I_{OUT} = 0\text{ mA to }300\text{ mA}$, $C_{OUT} = 10\text{ }\mu\text{F}$
 $T_j = 25\text{ }^\circ\text{C}$

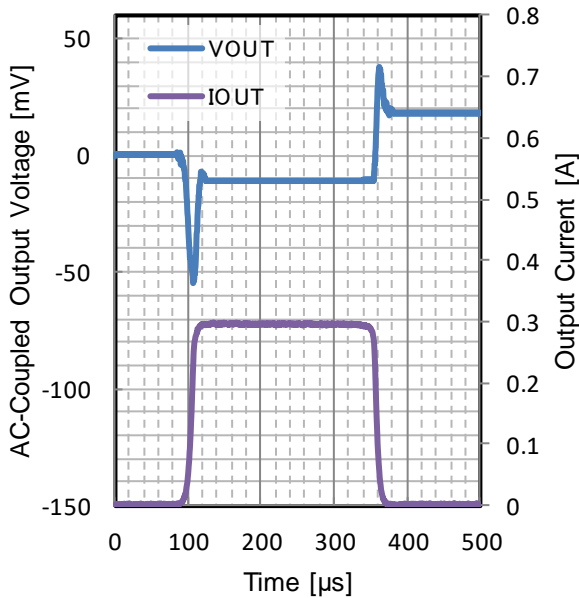

Figure 21. Load Transient

$V_{OUT} = 1.2\text{ V}$

$t_R = t_F = 10\text{ }\mu\text{s}$, $I_{OUT} = 0\text{ mA to }300\text{ mA}$, $C_{OUT} = 10\text{ }\mu\text{F}$
 $T_j = 150\text{ }^\circ\text{C}$

Typical Performance Curves (BU12JA3DG-C) - continued

Unless otherwise specified, $V_{IN} = 3.0\text{ V}$, $V_{EN} = 1.5\text{ V}$, $C_{IN} = 0.1\text{ }\mu\text{F}$, $C_{OUT} = 1.0\text{ }\mu\text{F}$

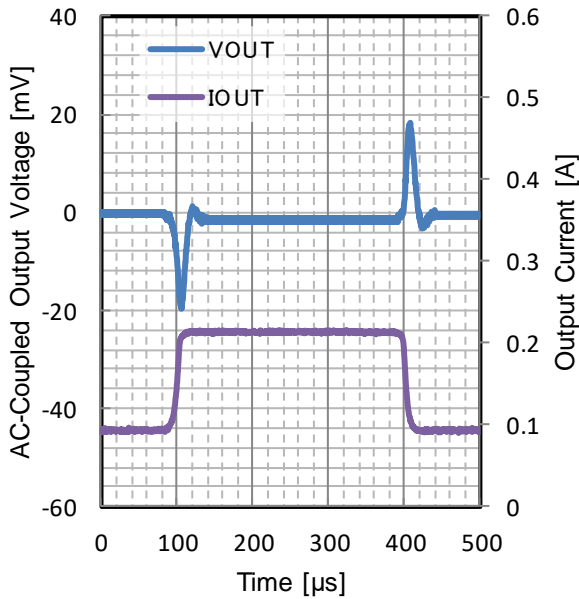

Figure 22. Load Transient

$V_{OUT} = 1.2\text{ V}$

$t_R = t_F = 10\text{ }\mu\text{s}$, $I_{OUT} = 90\text{ mA to }210\text{ mA}$, $C_{OUT} = 10\text{ }\mu\text{F}$
 $T_j = -40\text{ }^\circ\text{C}$

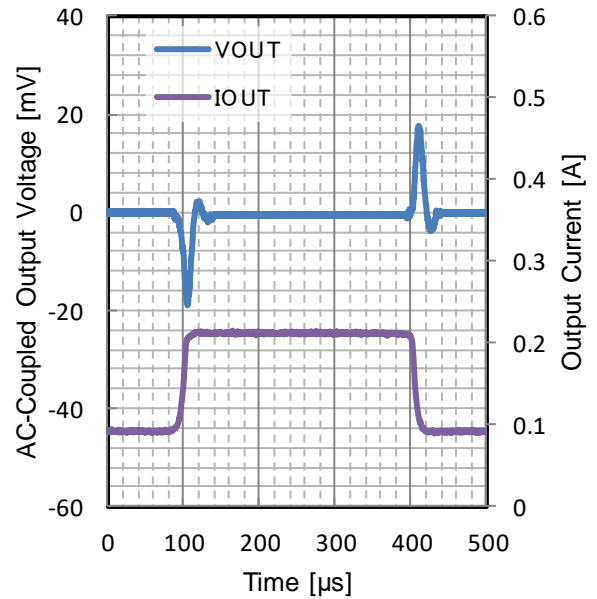

Figure 23. Load Transient

$V_{OUT} = 1.2\text{ V}$

$t_R = t_F = 10\text{ }\mu\text{s}$, $I_{OUT} = 90\text{ mA to }210\text{ mA}$, $C_{OUT} = 10\text{ }\mu\text{F}$
 $T_j = 25\text{ }^\circ\text{C}$

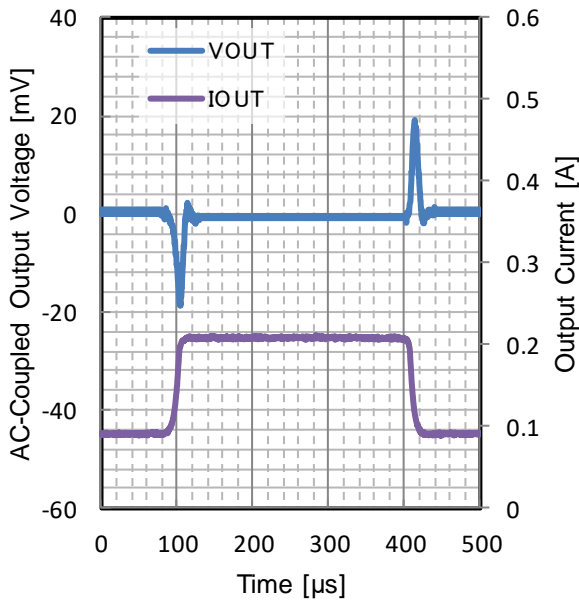

Figure 24. Load Transient

$V_{OUT} = 1.2\text{ V}$

$t_R = t_F = 10\text{ }\mu\text{s}$, $I_{OUT} = 90\text{ mA to }210\text{ mA}$, $C_{OUT} = 10\text{ }\mu\text{F}$
 $T_j = 150\text{ }^\circ\text{C}$

Typical Performance Curves (BU12JA3DG-C) - continued

Unless otherwise specified, $V_{IN} = 3.0\text{ V}$, $V_{EN} = 1.5\text{ V}$, $C_{IN} = 0.1\text{ }\mu\text{F}$, $C_{OUT} = 1.0\text{ }\mu\text{F}$

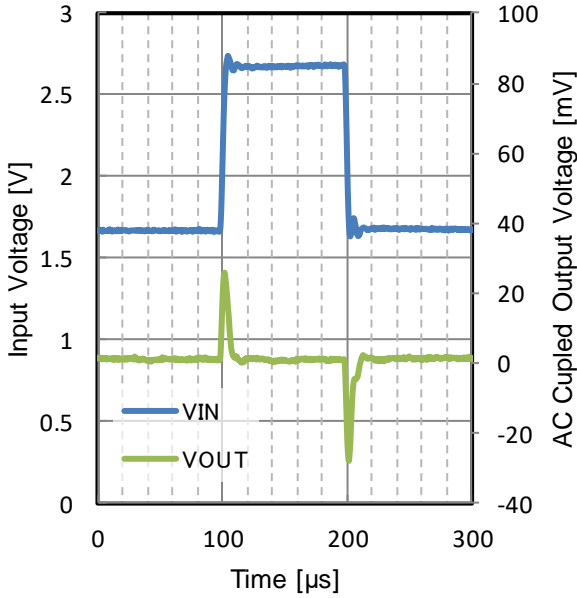

Figure 25. Line Transient
 $V_{OUT} = 1.2\text{ V}$
 $t_R = t_F = 1\text{ V}/\mu\text{s}$, $I_{OUT} = 50\text{ mA}$, $C_{OUT} = 10\text{ }\mu\text{F}$
 $T_j = -40\text{ }^\circ\text{C}$

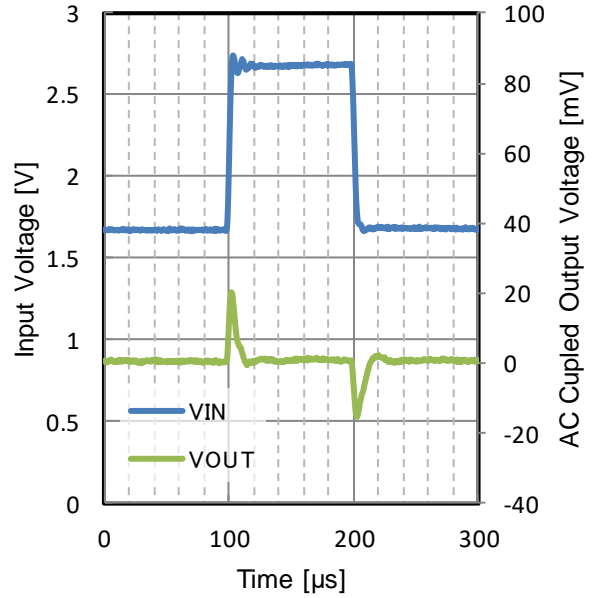

Figure 26. Line Transient
 $V_{OUT} = 1.2\text{ V}$
 $t_R = t_F = 1\text{ V}/\mu\text{s}$, $I_{OUT} = 50\text{ mA}$, $C_{OUT} = 10\text{ }\mu\text{F}$
 $T_j = 25\text{ }^\circ\text{C}$

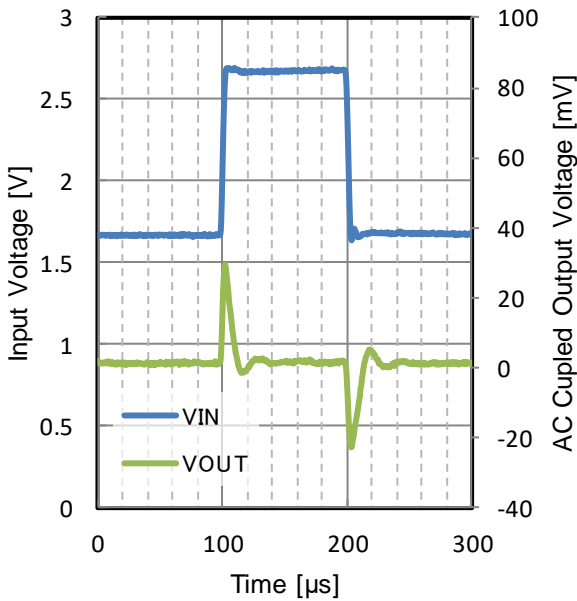

Figure 27. Line Transient
 $V_{OUT} = 1.2\text{ V}$
 $t_R = t_F = 1\text{ V}/\mu\text{s}$, $I_{OUT} = 50\text{ mA}$, $C_{OUT} = 10\text{ }\mu\text{F}$
 $T_j = 85\text{ }^\circ\text{C}$

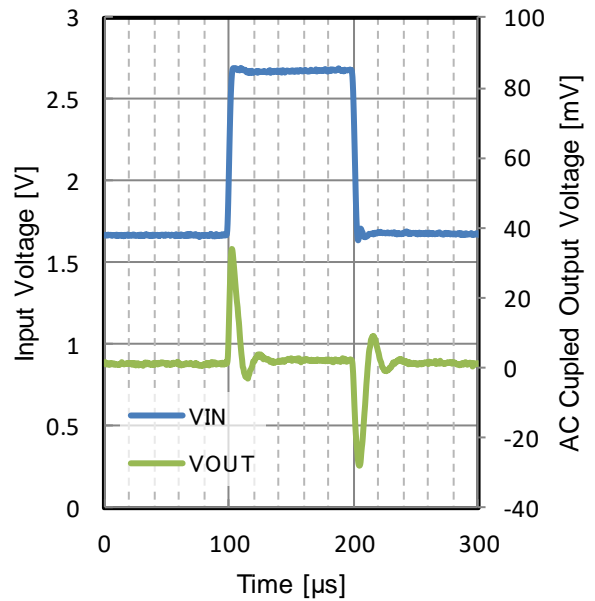

Figure 28. Line Transient
 $V_{OUT} = 1.2\text{ V}$
 $t_R = t_F = 1\text{ V}/\mu\text{s}$, $I_{OUT} = 50\text{ mA}$, $C_{OUT} = 10\text{ }\mu\text{F}$
 $T_j = 150\text{ }^\circ\text{C}$

Typical Performance Curves (BU12JA3DG-C) - continued

Unless otherwise specified, $V_{IN} = 3.0\text{ V}$, $V_{EN} = 1.5\text{ V}$, $C_{IN} = 0.1\text{ }\mu\text{F}$, $C_{OUT} = 1.0\text{ }\mu\text{F}$

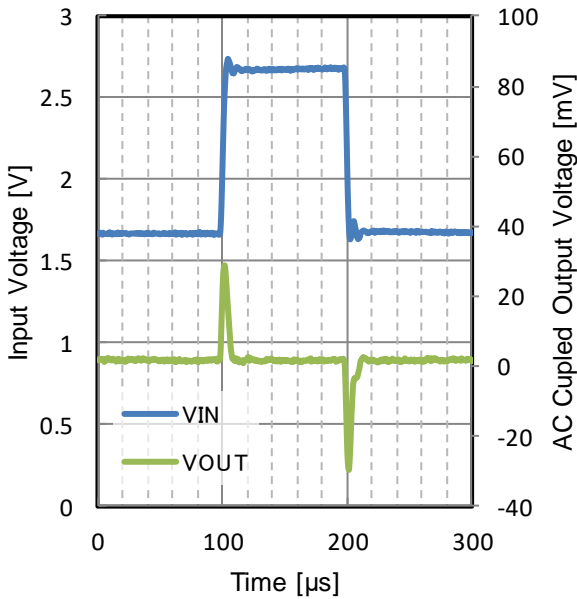

Figure 29. Line Transient
 $V_{OUT} = 1.2\text{ V}$
 $t_R = t_F = 1\text{ V}/\mu\text{s}$, $I_{OUT} = 100\text{ mA}$, $C_{OUT} = 10\text{ }\mu\text{F}$
 $T_j = -40\text{ }^\circ\text{C}$

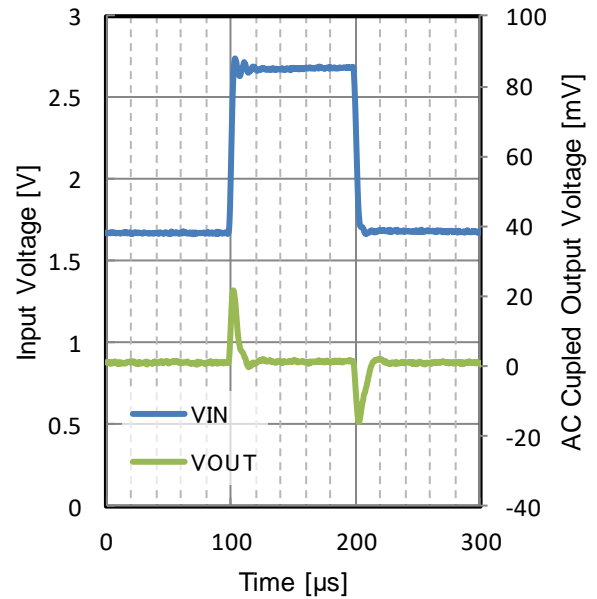

Figure 30. Line Transient
 $V_{OUT} = 1.2\text{ V}$
 $t_R = t_F = 1\text{ V}/\mu\text{s}$, $I_{OUT} = 100\text{ mA}$, $C_{OUT} = 10\text{ }\mu\text{F}$
 $T_j = 25\text{ }^\circ\text{C}$

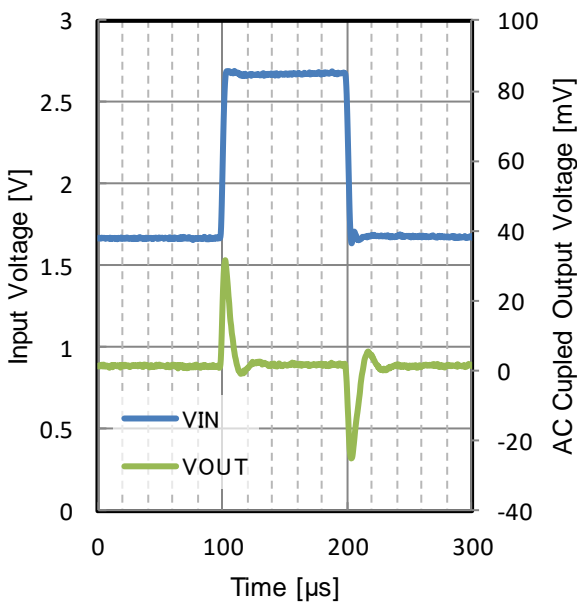

Figure 31. Line Transient
 $V_{OUT} = 1.2\text{ V}$
 $t_R = t_F = 1\text{ V}/\mu\text{s}$, $I_{OUT} = 100\text{ mA}$, $C_{OUT} = 10\text{ }\mu\text{F}$
 $T_j = 85\text{ }^\circ\text{C}$

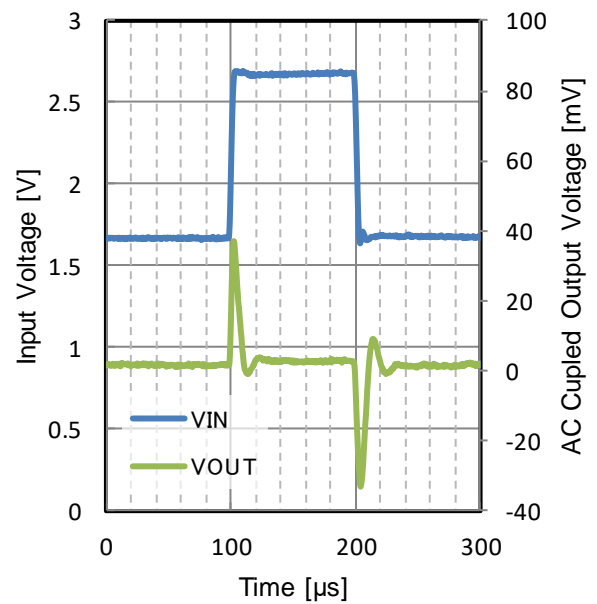

Figure 32. Line Transient
 $V_{OUT} = 1.2\text{ V}$
 $t_R = t_F = 1\text{ V}/\mu\text{s}$, $I_{OUT} = 100\text{ mA}$, $C_{OUT} = 10\text{ }\mu\text{F}$
 $T_j = 150\text{ }^\circ\text{C}$

Typical Performance Curves (BU12JA3DG-C) - continued

Unless otherwise specified, $V_{IN} = 3.0\text{ V}$, $V_{EN} = 1.5\text{ V}$, $C_{IN} = 0.1\text{ }\mu\text{F}$, $C_{OUT} = 1.0\text{ }\mu\text{F}$

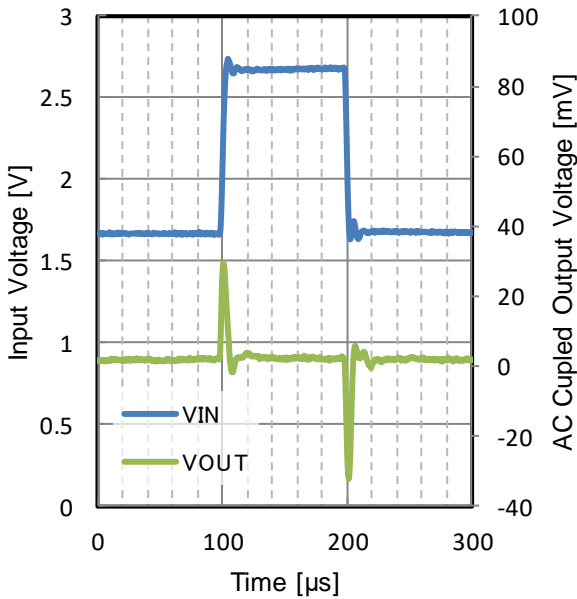

Figure 33. Line Transient
 $V_{OUT} = 1.2\text{ V}$
 $t_R = t_F = 1\text{ V}/\mu\text{s}$, $I_{OUT} = 300\text{ mA}$, $C_{OUT} = 10\text{ }\mu\text{F}$
 $T_j = -40\text{ }^\circ\text{C}$

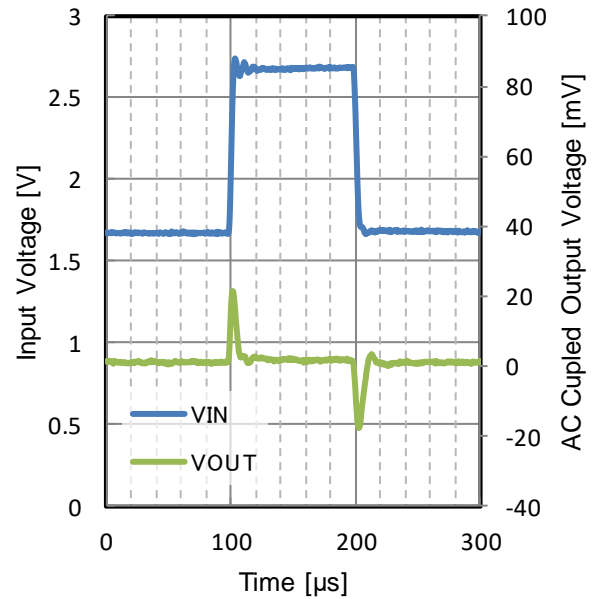

Figure 34. Line Transient
 $V_{OUT} = 1.2\text{ V}$
 $t_R = t_F = 1\text{ V}/\mu\text{s}$, $I_{OUT} = 300\text{ mA}$, $C_{OUT} = 10\text{ }\mu\text{F}$
 $T_j = 25\text{ }^\circ\text{C}$

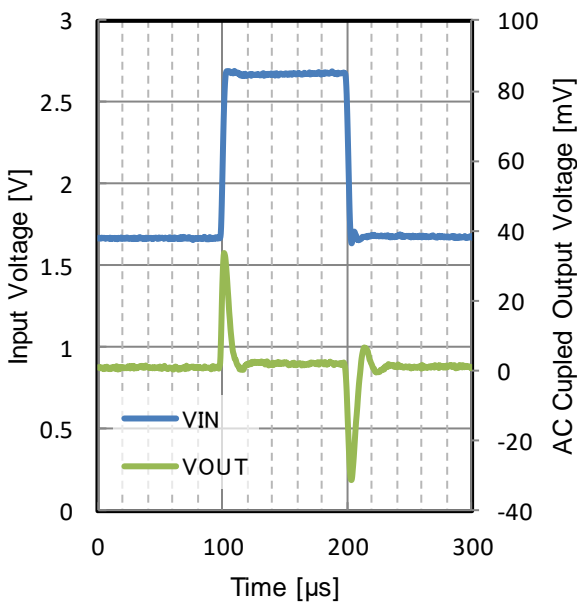

Figure 35. Line Transient
 $V_{OUT} = 1.2\text{ V}$
 $t_R = t_F = 1\text{ V}/\mu\text{s}$, $I_{OUT} = 300\text{ mA}$, $C_{OUT} = 10\text{ }\mu\text{F}$
 $T_j = 85\text{ }^\circ\text{C}$

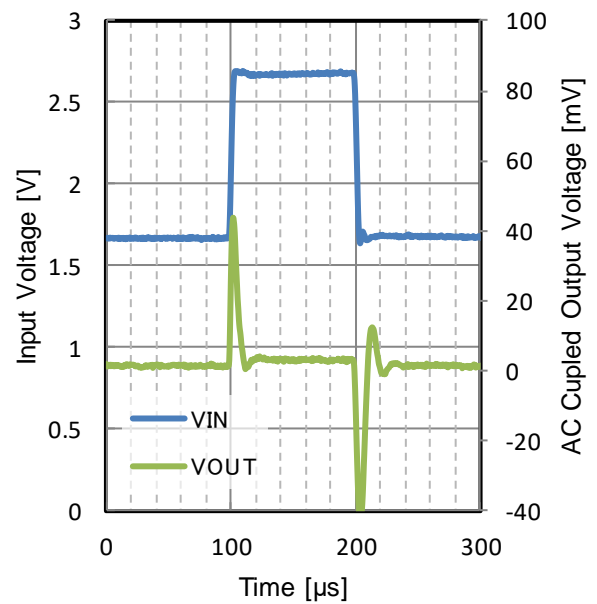

Figure 36. Line Transient
 $V_{OUT} = 1.2\text{ V}$
 $t_R = t_F = 1\text{ V}/\mu\text{s}$, $I_{OUT} = 300\text{ mA}$, $C_{OUT} = 10\text{ }\mu\text{F}$
 $T_j = 150\text{ }^\circ\text{C}$

Typical Performance Curves (BU12JA3DG-C) - continued

Unless otherwise specified, $V_{IN} = 3.0\text{ V}$, $V_{EN} = 1.5\text{ V}$, $C_{IN} = 0.1\ \mu\text{F}$, $C_{OUT} = 1.0\ \mu\text{F}$

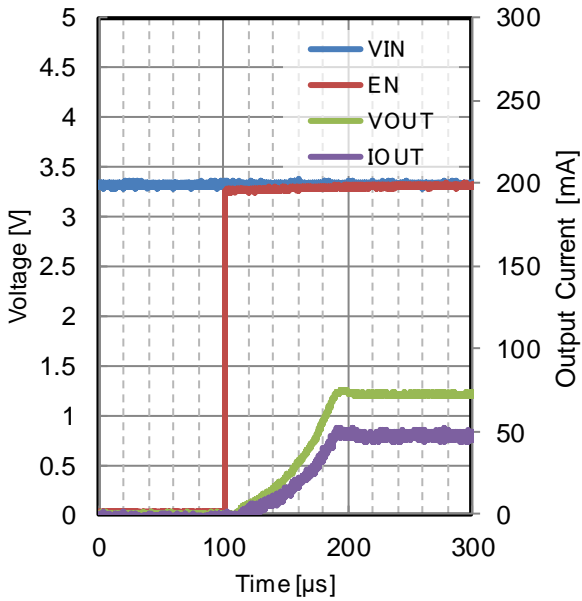

Figure 37. Start Up Waveform
 $V_{OUT} = 1.2\text{ V}$, $I_{OUT} = 50\text{ mA}$
 $V_{IN} = 3.3\text{ V}$, $C_{OUT} = 10\ \mu\text{F}$
 $T_j = -40\text{ }^\circ\text{C}$

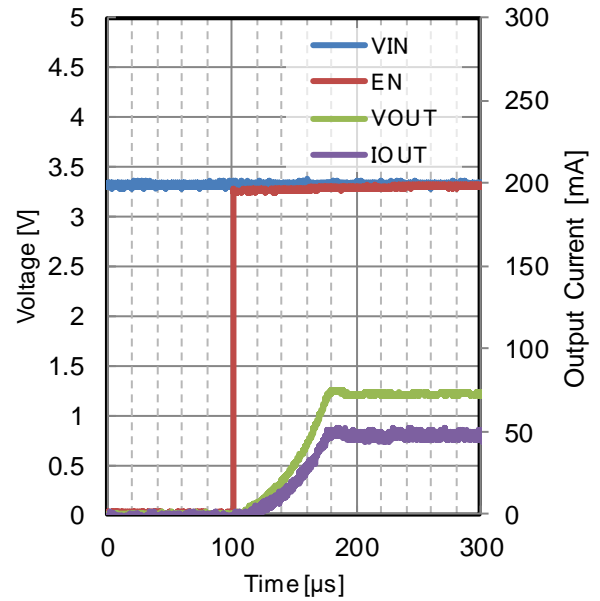

Figure 38. Start Up Waveform
 $V_{OUT} = 1.2\text{ V}$, $I_{OUT} = 50\text{ mA}$
 $V_{IN} = 3.3\text{ V}$, $C_{OUT} = 10\ \mu\text{F}$
 $T_j = 25\text{ }^\circ\text{C}$

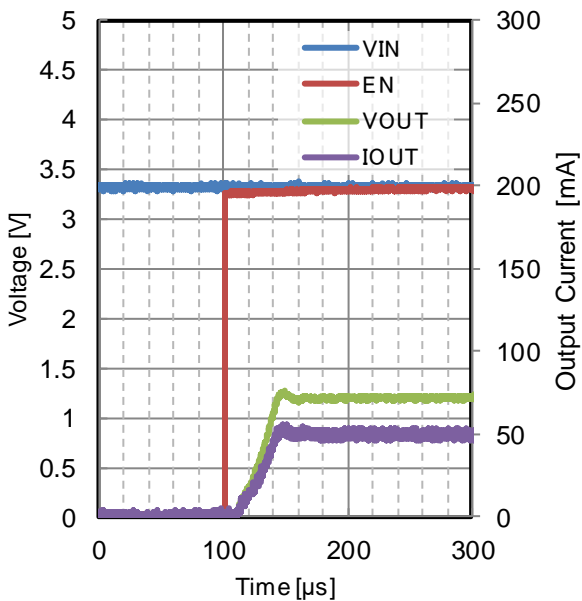

Figure 39. Start Up Waveform
 $V_{OUT} = 1.2\text{ V}$, $I_{OUT} = 50\text{ mA}$
 $V_{IN} = 3.3\text{ V}$, $C_{OUT} = 10\ \mu\text{F}$
 $T_j = 150\text{ }^\circ\text{C}$

Typical Performance Curves (BU12JA3DG-C) - continued

Unless otherwise specified, $V_{IN} = 3.0\text{ V}$, $V_{EN} = 1.5\text{ V}$, $C_{IN} = 0.1\text{ }\mu\text{F}$, $C_{OUT} = 1.0\text{ }\mu\text{F}$

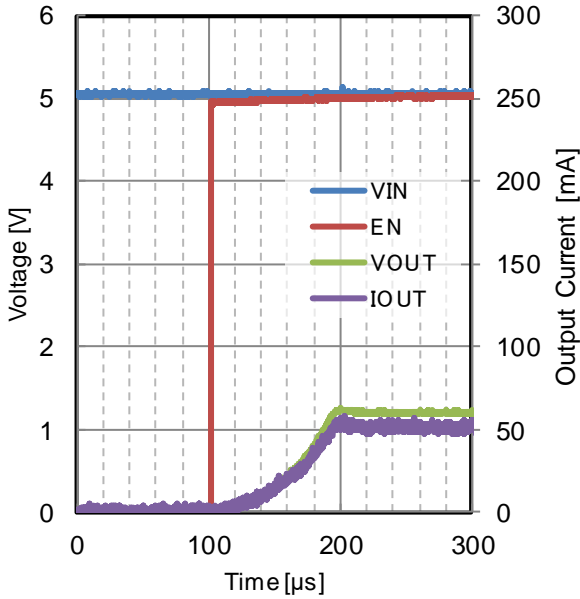

Figure 40. Start Up Waveform
 $V_{OUT} = 1.2\text{ V}$, $I_{OUT} = 50\text{ mA}$
 $V_{IN} = 5.0\text{ V}$, $C_{OUT} = 10\text{ }\mu\text{F}$
 $T_j = -40\text{ }^\circ\text{C}$

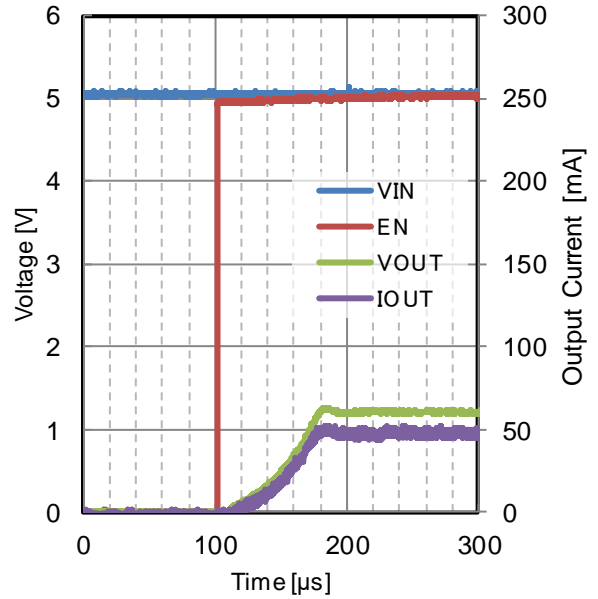

Figure 41. Start Up Waveform
 $V_{OUT} = 1.2\text{ V}$, $I_{OUT} = 50\text{ mA}$
 $V_{IN} = 5.0\text{ V}$, $C_{OUT} = 10\text{ }\mu\text{F}$
 $T_j = 25\text{ }^\circ\text{C}$

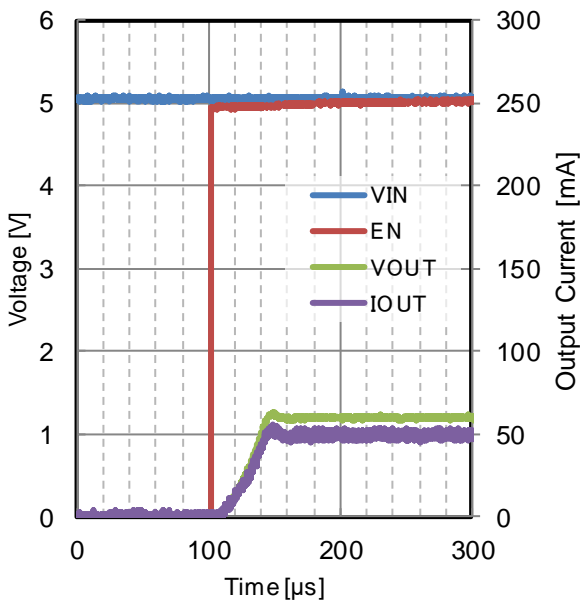

Figure 42. Start Up Waveform
 $V_{OUT} = 1.2\text{ V}$, $I_{OUT} = 50\text{ mA}$
 $V_{IN} = 5.0\text{ V}$, $C_{OUT} = 10\text{ }\mu\text{F}$
 $T_j = 150\text{ }^\circ\text{C}$

Typical Performance Curves (BU15JA3DG-C)

Unless otherwise specified, $V_{IN} = 3.0\text{ V}$, $V_{EN} = 1.5\text{ V}$, $C_{IN} = 0.1\text{ }\mu\text{F}$, $C_{OUT} = 1.0\text{ }\mu\text{F}$

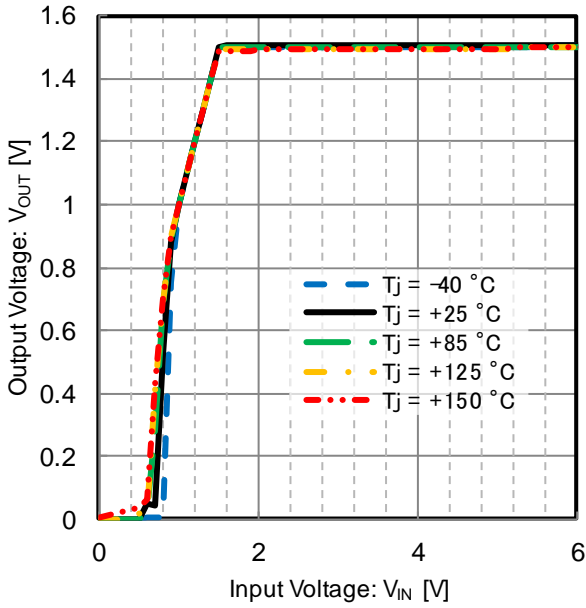

Figure 43. Output Voltage vs Input Voltage
 $V_{OUT} = 1.5\text{ V}$

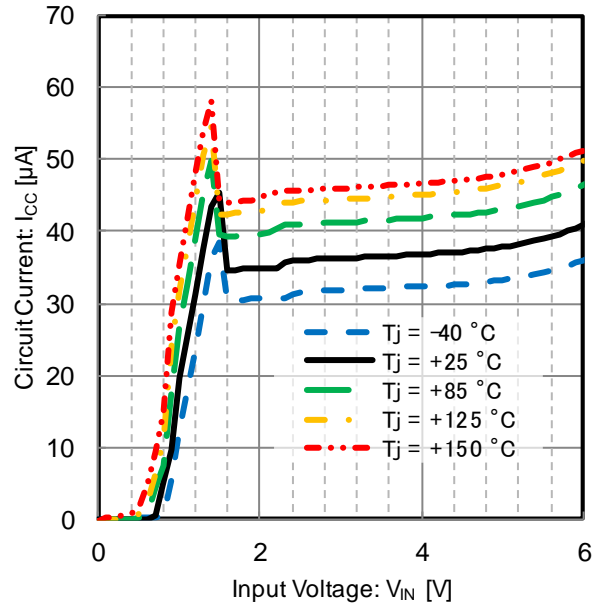

Figure 44. Circuit Current vs Input Voltage
 $V_{OUT} = 1.5\text{ V}$

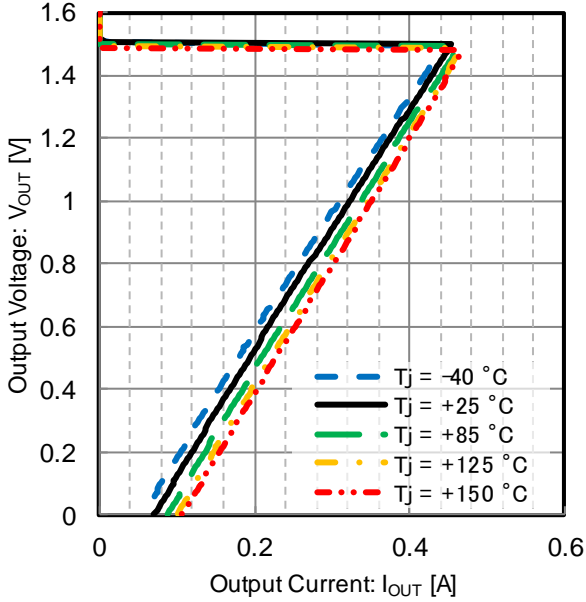

Figure 45. Output Current Limit
 $V_{OUT} = 1.5\text{ V}$

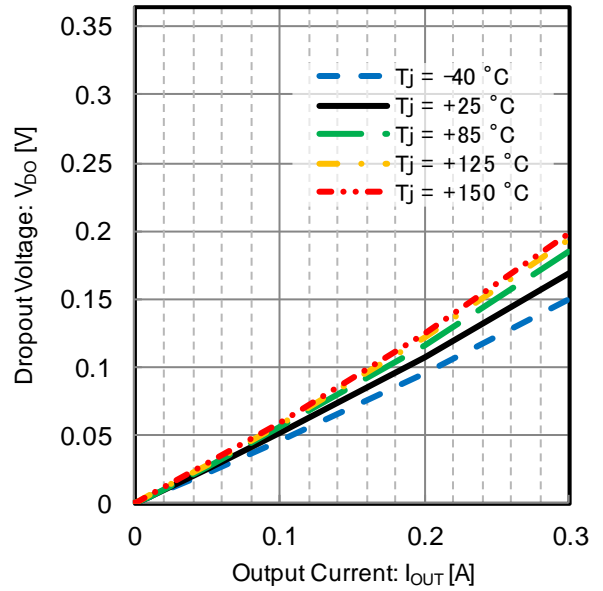

Figure 46. Dropout Voltage vs Output Current
 $V_{IN} = 1.7\text{ V}$, $V_{OUT} = 1.5\text{ V}$

Typical Performance Curves (BU15JA3DG-C) - continued

Unless otherwise specified, $V_{IN} = 3.0\text{ V}$, $V_{EN} = 1.5\text{ V}$, $C_{IN} = 0.1\text{ }\mu\text{F}$, $C_{OUT} = 1.0\text{ }\mu\text{F}$

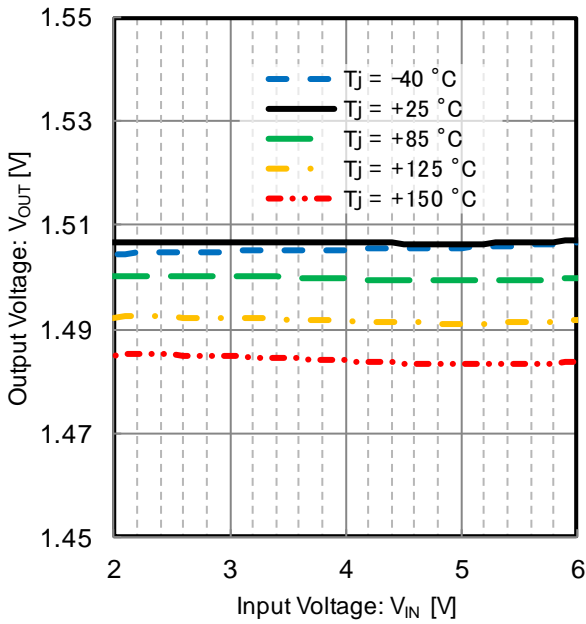

Figure 47. Line Regulation
 $V_{OUT} = 1.5\text{ V}$, $I_{OUT} = 50\text{ mA}$

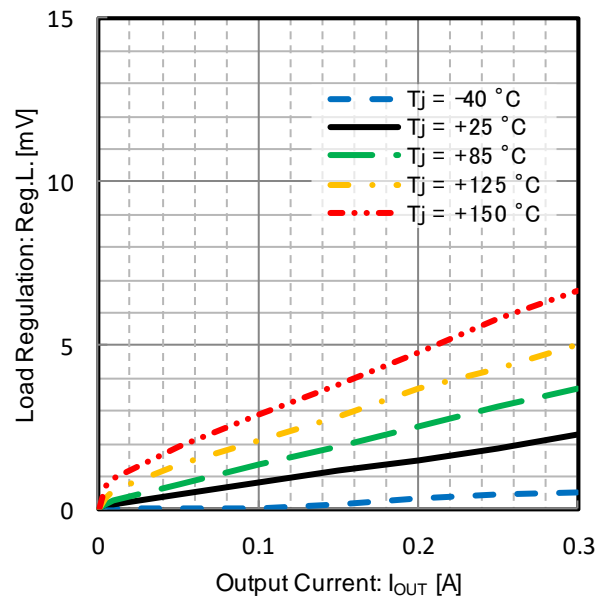

Figure 48. Load Regulation
 $V_{OUT} = 1.5\text{ V}$, $I_{OUT} = 1\text{ mA}$ to 300 mA

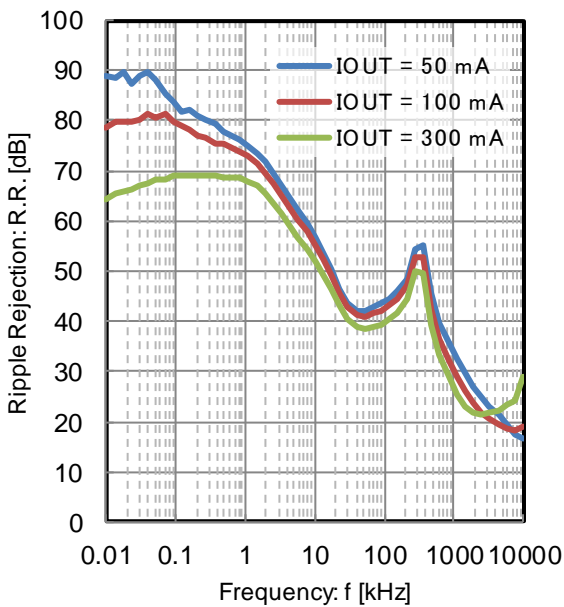

Figure 49. PSRR vs Frequency and Output Current
 $C_{IN} = 0\text{ }\mu\text{F}$, $C_{OUT} = 10\text{ }\mu\text{F}$
 $V_{OUT} = 1.5\text{ V}$

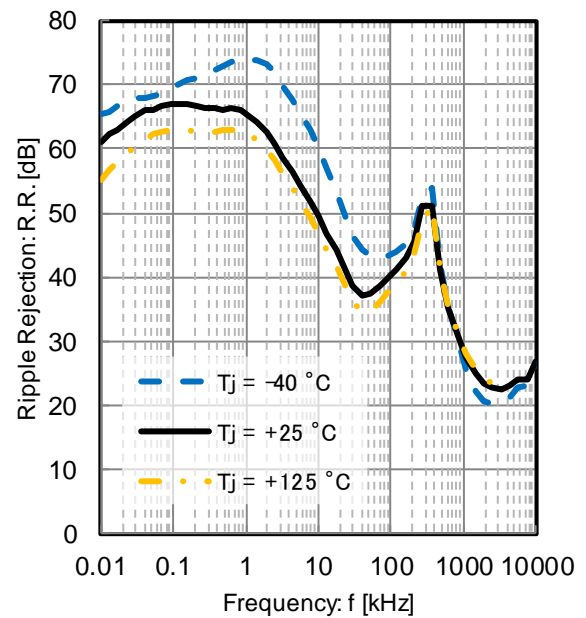

Figure 50. PSRR vs Frequency and Temperature
 $C_{IN} = 0\text{ }\mu\text{F}$, $C_{OUT} = 10\text{ }\mu\text{F}$
 $V_{IN} = 5\text{ V}$, $V_{OUT} = 1.5\text{ V}$, $I_{OUT} = 300\text{ mA}$

Typical Performance Curves (BU15JA3DG-C) - continued

Unless otherwise specified, $V_{IN} = 3.0\text{ V}$, $V_{EN} = 1.5\text{ V}$, $C_{IN} = 0.1\text{ }\mu\text{F}$, $C_{OUT} = 1.0\text{ }\mu\text{F}$

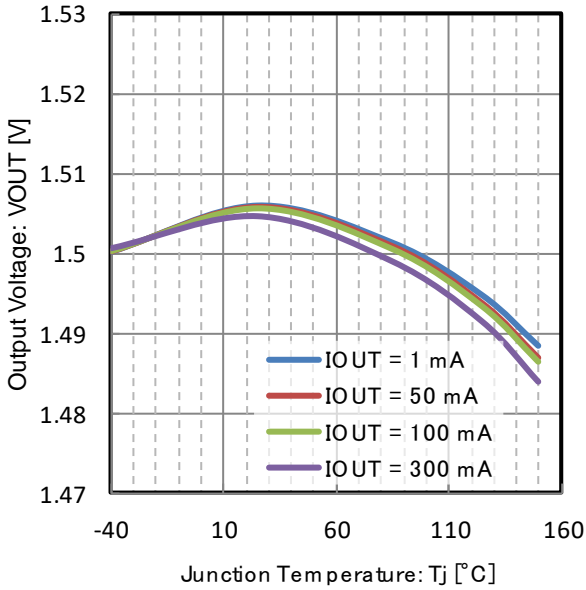

Figure 51. Output Voltage vs Junction temperature
 $V_{OUT} = 1.5\text{ V}$

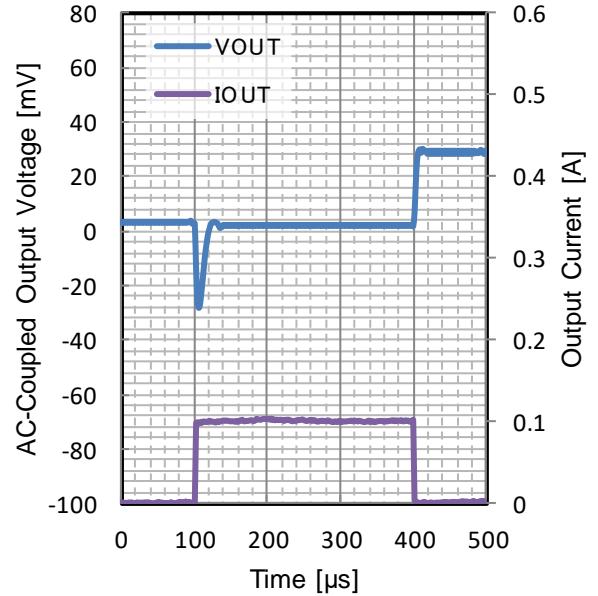

Figure 52. Load Transient
 $V_{OUT} = 1.5\text{ V}$
 $t_R = t_F = 1\text{ }\mu\text{s}$, $I_{OUT} = 0\text{ mA to }100\text{ mA}$, $C_{OUT} = 10\text{ }\mu\text{F}$
 $T_j = -40\text{ }^\circ\text{C}$

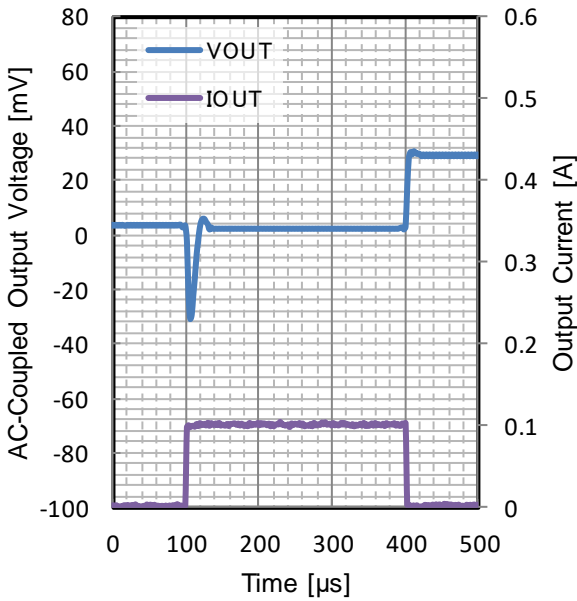

Figure 53. Load Transient
 $V_{OUT} = 1.5\text{ V}$
 $t_R = t_F = 1\text{ }\mu\text{s}$, $I_{OUT} = 0\text{ mA to }100\text{ mA}$, $C_{OUT} = 10\text{ }\mu\text{F}$
 $T_j = 25\text{ }^\circ\text{C}$

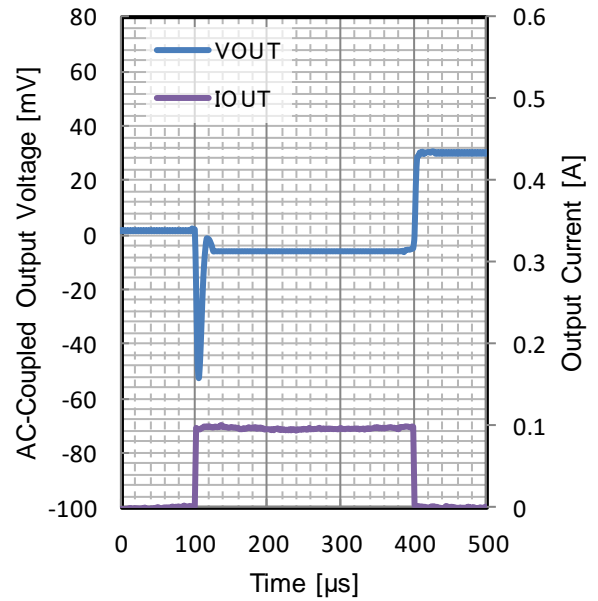

Figure 54. Load Transient
 $V_{OUT} = 1.5\text{ V}$
 $t_R = t_F = 1\text{ }\mu\text{s}$, $I_{OUT} = 0\text{ mA to }100\text{ mA}$, $C_{OUT} = 10\text{ }\mu\text{F}$
 $T_j = 150\text{ }^\circ\text{C}$

Typical Performance Curves (BU15JA3DG-C) - continued

Unless otherwise specified, $V_{IN} = 3.0\text{ V}$, $V_{EN} = 1.5\text{ V}$, $C_{IN} = 0.1\text{ }\mu\text{F}$, $C_{OUT} = 1.0\text{ }\mu\text{F}$

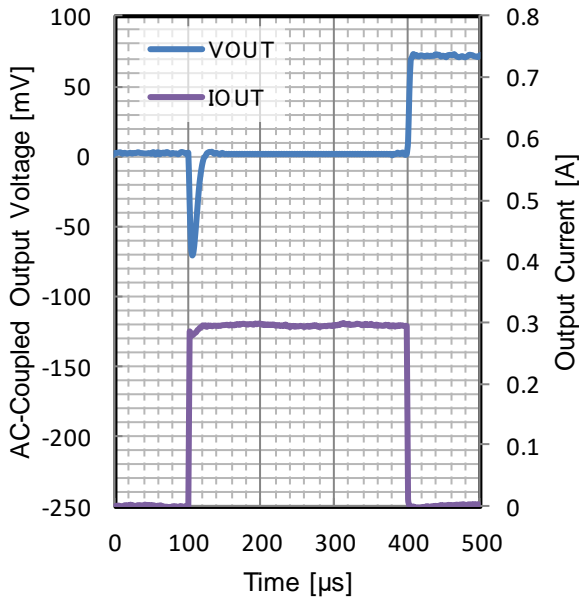

Figure 55. Load Transient

$V_{OUT} = 1.5\text{ V}$

$t_R = t_F = 1\text{ }\mu\text{s}$, $I_{OUT} = 0\text{ mA to }300\text{ mA}$, $C_{OUT} = 10\text{ }\mu\text{F}$
 $T_j = -40\text{ }^\circ\text{C}$

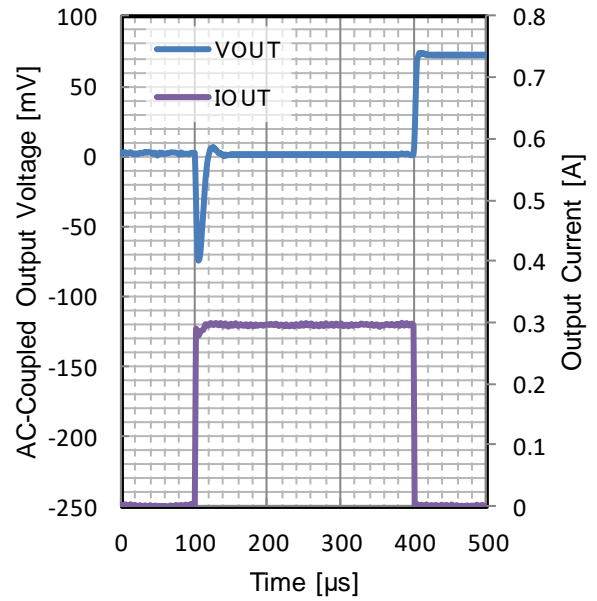

Figure 56. Load Transient

$V_{OUT} = 1.5\text{ V}$

$t_R = t_F = 1\text{ }\mu\text{s}$, $I_{OUT} = 0\text{ mA to }300\text{ mA}$, $C_{OUT} = 10\text{ }\mu\text{F}$
 $T_j = 25\text{ }^\circ\text{C}$

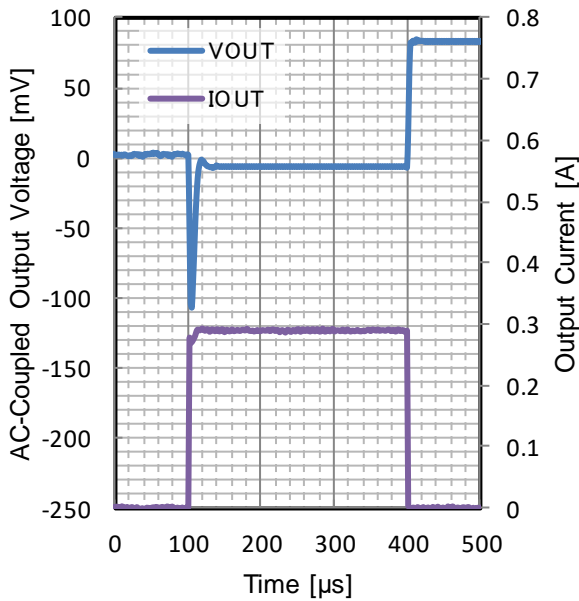

Figure 57. Load Transient

$V_{OUT} = 1.5\text{ V}$

$t_R = t_F = 1\text{ }\mu\text{s}$, $I_{OUT} = 0\text{ mA to }300\text{ mA}$, $C_{OUT} = 10\text{ }\mu\text{F}$
 $T_j = 150\text{ }^\circ\text{C}$

Typical Performance Curves (BU15JA3DG-C) - continued

Unless otherwise specified, $V_{IN} = 3.0\text{ V}$, $V_{EN} = 1.5\text{ V}$, $C_{IN} = 0.1\text{ }\mu\text{F}$, $C_{OUT} = 1.0\text{ }\mu\text{F}$

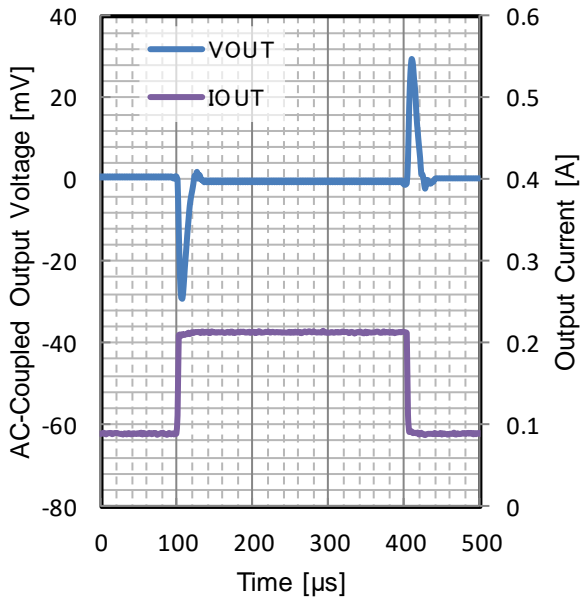

Figure 58. Load Transient

$V_{OUT} = 1.5\text{ V}$

$t_r = t_f = 1\text{ }\mu\text{s}$, $I_{OUT} = 90\text{ mA to }210\text{ mA}$, $C_{OUT} = 10\text{ }\mu\text{F}$
 $T_j = -40\text{ }^\circ\text{C}$

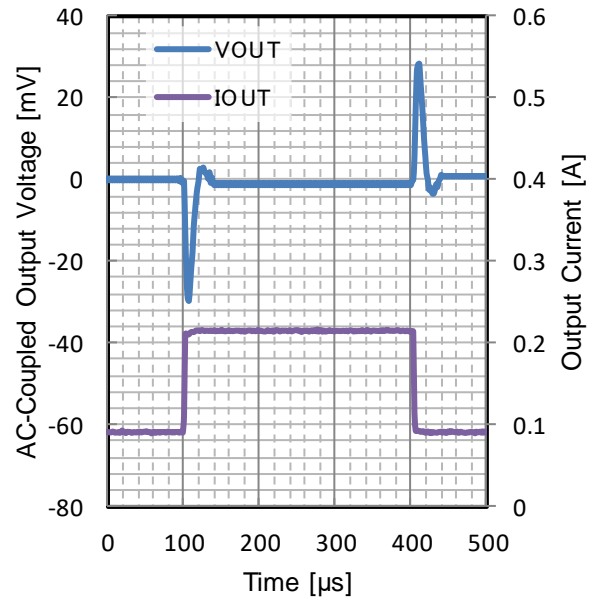

Figure 59. Load Transient

$V_{OUT} = 1.5\text{ V}$

$t_r = t_f = 1\text{ }\mu\text{s}$, $I_{OUT} = 90\text{ mA to }210\text{ mA}$, $C_{OUT} = 10\text{ }\mu\text{F}$
 $T_j = 25\text{ }^\circ\text{C}$

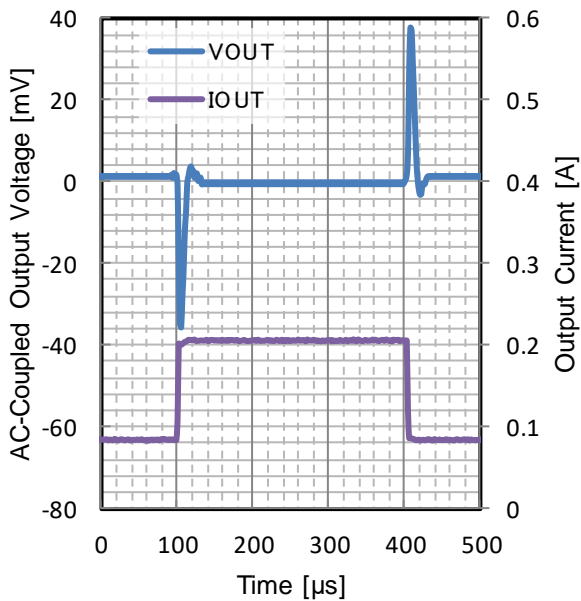

Figure 60. Load Transient

$V_{OUT} = 1.5\text{ V}$

$t_r = t_f = 1\text{ }\mu\text{s}$, $I_{OUT} = 90\text{ mA to }210\text{ mA}$, $C_{OUT} = 10\text{ }\mu\text{F}$
 $T_j = 150\text{ }^\circ\text{C}$

Typical Performance Curves (BU15JA3DG-C) - continued

Unless otherwise specified, $V_{IN} = 3.0\text{ V}$, $V_{EN} = 1.5\text{ V}$, $C_{IN} = 0.1\text{ }\mu\text{F}$, $C_{OUT} = 1.0\text{ }\mu\text{F}$

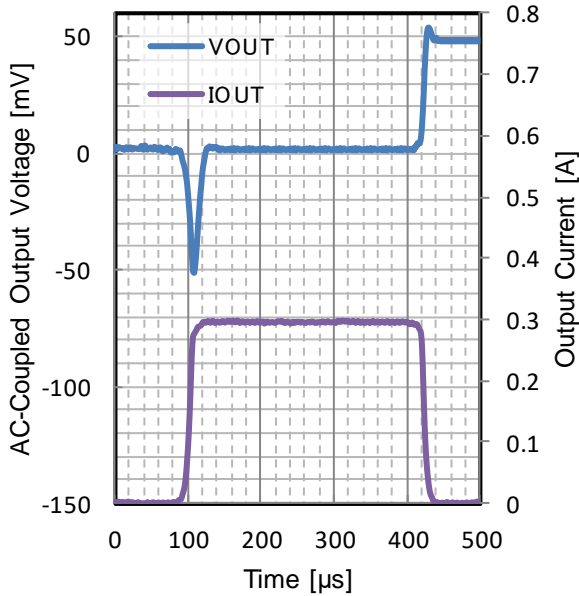

Figure 61. Load Transient

$V_{OUT} = 1.5\text{ V}$

$t_R = t_F = 10\text{ }\mu\text{s}$, $I_{OUT} = 0\text{ mA to }300\text{ mA}$, $C_{OUT} = 10\text{ }\mu\text{F}$
 $T_j = -40\text{ }^\circ\text{C}$

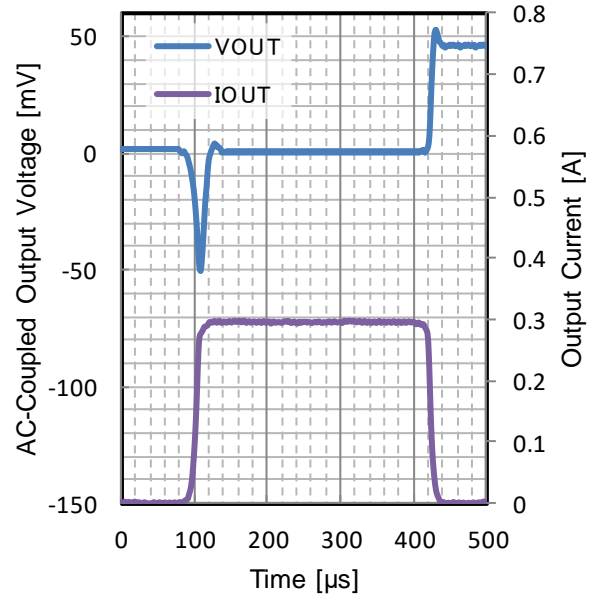

Figure 62. Load Transient

$V_{OUT} = 1.5\text{ V}$

$t_R = t_F = 10\text{ }\mu\text{s}$, $I_{OUT} = 0\text{ mA to }300\text{ mA}$, $C_{OUT} = 10\text{ }\mu\text{F}$
 $T_j = 25\text{ }^\circ\text{C}$

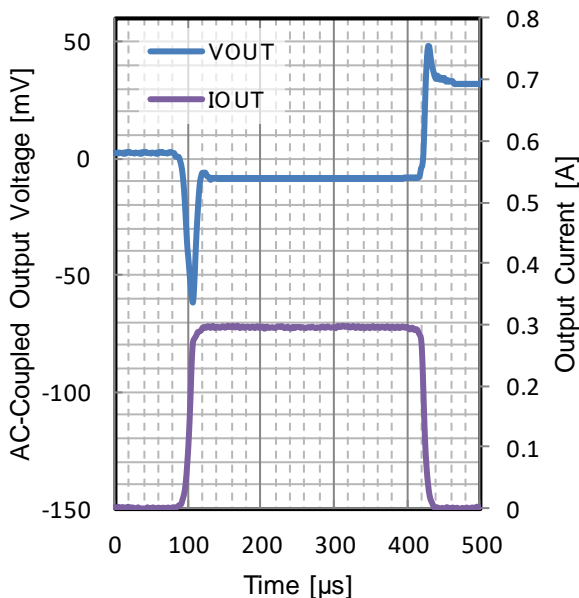

Figure 63. Load Transient

$V_{OUT} = 1.5\text{ V}$

$t_R = t_F = 10\text{ }\mu\text{s}$, $I_{OUT} = 0\text{ mA to }300\text{ mA}$, $C_{OUT} = 10\text{ }\mu\text{F}$
 $T_j = 150\text{ }^\circ\text{C}$

Typical Performance Curves (BU15JA3DG-C) - continued

Unless otherwise specified, $V_{IN} = 3.0\text{ V}$, $V_{EN} = 1.5\text{ V}$, $C_{IN} = 0.1\text{ }\mu\text{F}$, $C_{OUT} = 1.0\text{ }\mu\text{F}$

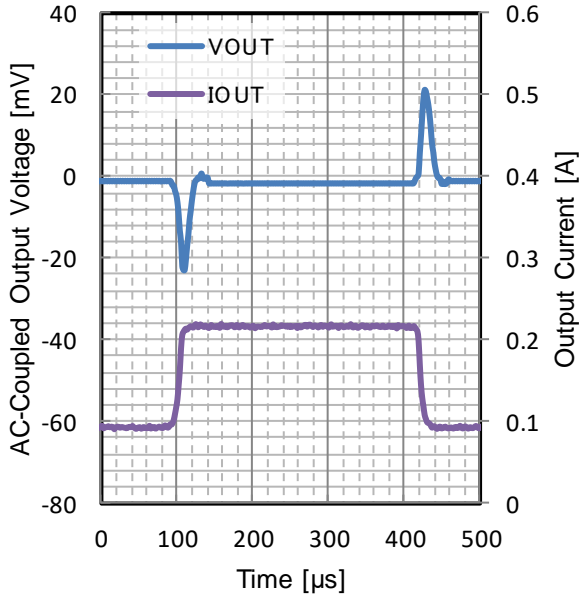

Figure 64. Load Transient

$V_{OUT} = 1.5\text{ V}$

$t_R = t_F = 10\text{ }\mu\text{s}$, $I_{OUT} = 90\text{ mA to }210\text{ mA}$, $C_{OUT} = 10\text{ }\mu\text{F}$
 $T_j = -40\text{ }^\circ\text{C}$

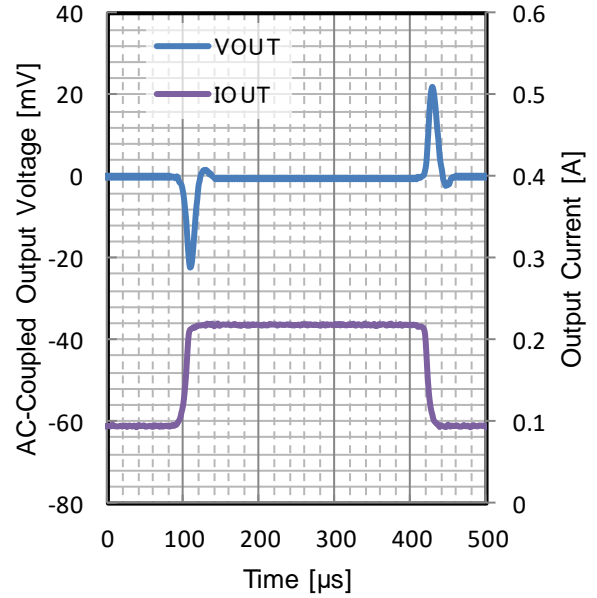

Figure 65. Load Transient

$V_{OUT} = 1.5\text{ V}$

$t_R = t_F = 10\text{ }\mu\text{s}$, $I_{OUT} = 90\text{ mA to }210\text{ mA}$, $C_{OUT} = 10\text{ }\mu\text{F}$
 $T_j = 25\text{ }^\circ\text{C}$

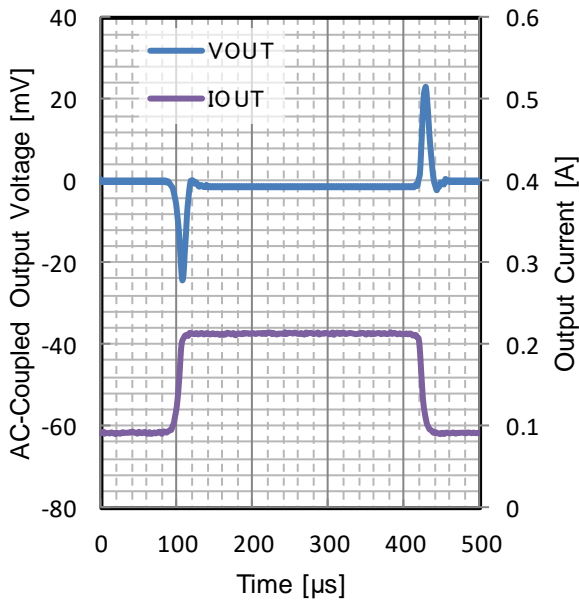

Figure 66. Load Transient

$V_{OUT} = 1.5\text{ V}$

$t_R = t_F = 10\text{ }\mu\text{s}$, $I_{OUT} = 90\text{ mA to }210\text{ mA}$, $C_{OUT} = 10\text{ }\mu\text{F}$
 $T_j = 150\text{ }^\circ\text{C}$

Typical Performance Curves (BU15JA3DG-C) - continued

Unless otherwise specified, $V_{IN} = 3.0\text{ V}$, $V_{EN} = 1.5\text{ V}$, $C_{IN} = 0.1\text{ }\mu\text{F}$, $C_{OUT} = 1.0\text{ }\mu\text{F}$

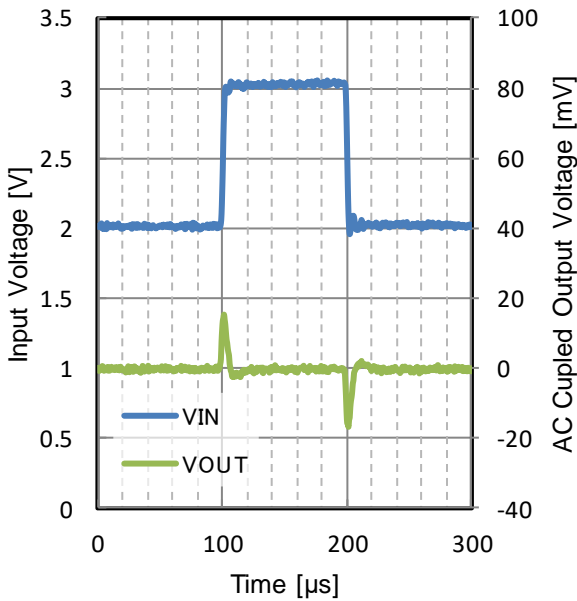

Figure 67. Line Transient
 $V_{OUT} = 1.5\text{ V}$
 $t_R = t_F = 1\text{ V}/\mu\text{s}$, $I_{OUT} = 50\text{ mA}$, $C_{OUT} = 10\text{ }\mu\text{F}$
 $T_j = -40\text{ }^\circ\text{C}$

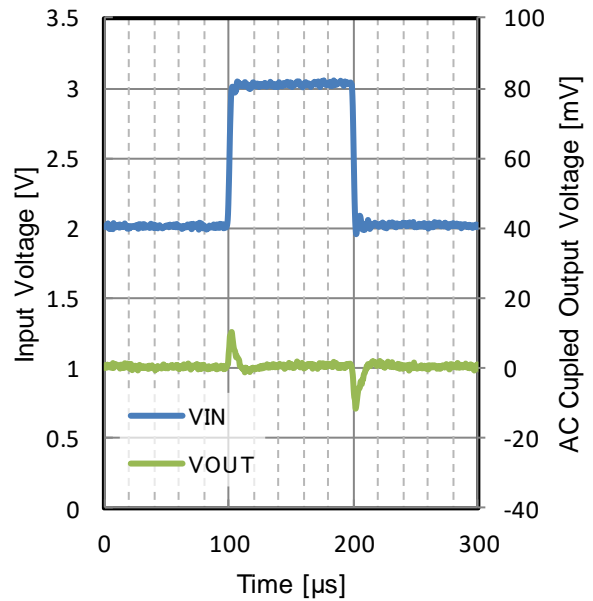

Figure 68. Line Transient
 $V_{OUT} = 1.5\text{ V}$
 $t_R = t_F = 1\text{ V}/\mu\text{s}$, $I_{OUT} = 50\text{ mA}$, $C_{OUT} = 10\text{ }\mu\text{F}$
 $T_j = 25\text{ }^\circ\text{C}$

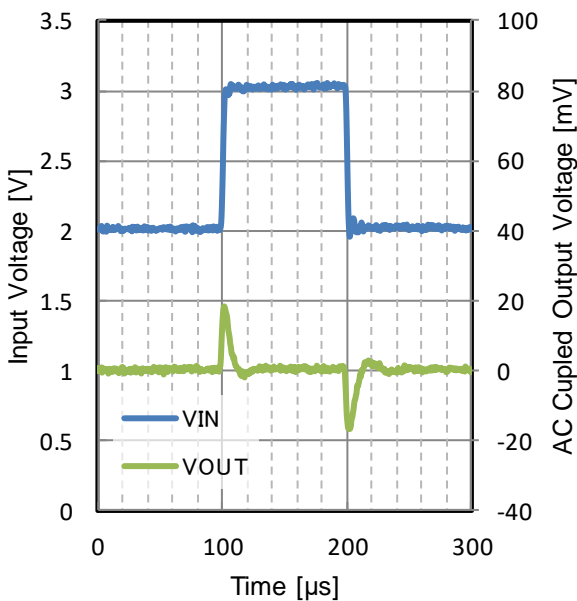

Figure 69. Line Transient
 $V_{OUT} = 1.5\text{ V}$
 $t_R = t_F = 1\text{ V}/\mu\text{s}$, $I_{OUT} = 50\text{ mA}$, $C_{OUT} = 10\text{ }\mu\text{F}$
 $T_j = 85\text{ }^\circ\text{C}$

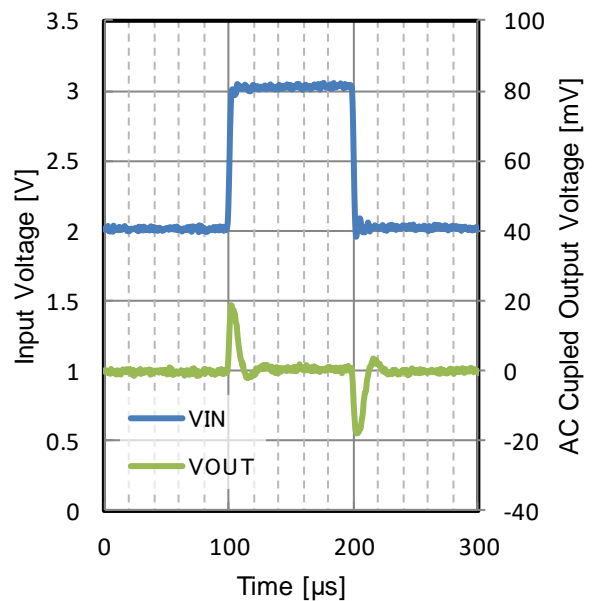

Figure 70. Line Transient
 $V_{OUT} = 1.5\text{ V}$
 $t_R = t_F = 1\text{ V}/\mu\text{s}$, $I_{OUT} = 50\text{ mA}$, $C_{OUT} = 10\text{ }\mu\text{F}$
 $T_j = 150\text{ }^\circ\text{C}$

Typical Performance Curves (BU15JA3DG-C) - continued

Unless otherwise specified, $V_{IN} = 3.0\text{ V}$, $V_{EN} = 1.5\text{ V}$, $C_{IN} = 0.1\text{ }\mu\text{F}$, $C_{OUT} = 1.0\text{ }\mu\text{F}$

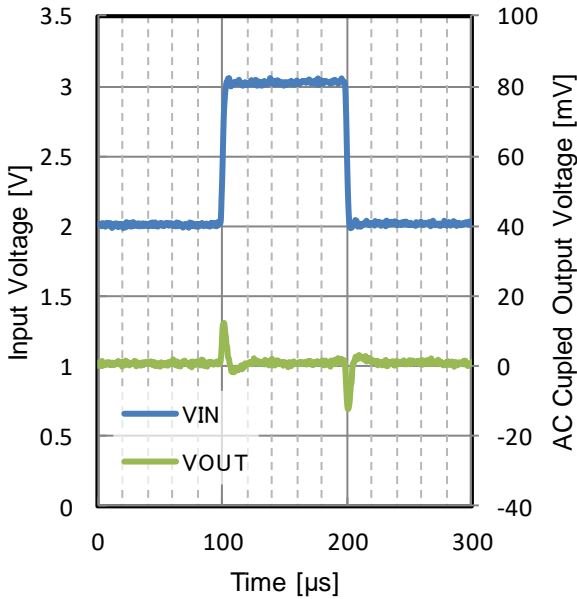

Figure 71. Line Transient
 $V_{OUT} = 1.5\text{ V}$
 $t_R = t_F = 1\text{ V}/\mu\text{s}$, $I_{OUT} = 100\text{ mA}$, $C_{OUT} = 10\text{ }\mu\text{F}$
 $T_j = -40\text{ }^\circ\text{C}$

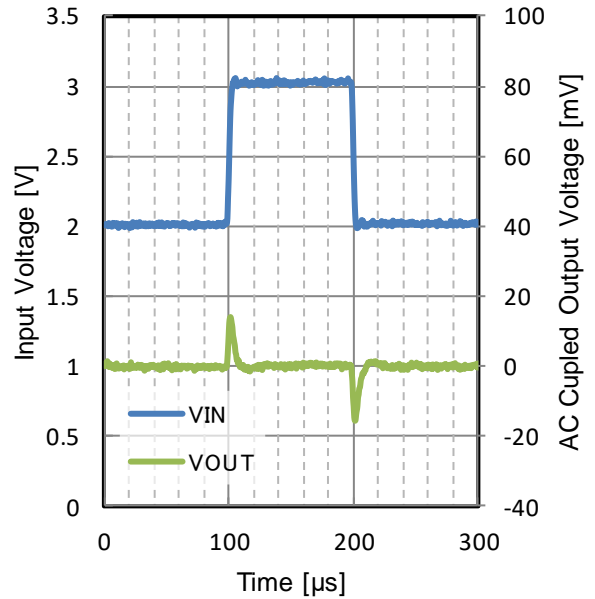

Figure 72. Line Transient
 $V_{OUT} = 1.5\text{ V}$
 $t_R = t_F = 1\text{ V}/\mu\text{s}$, $I_{OUT} = 100\text{ mA}$, $C_{OUT} = 10\text{ }\mu\text{F}$
 $T_j = 25\text{ }^\circ\text{C}$

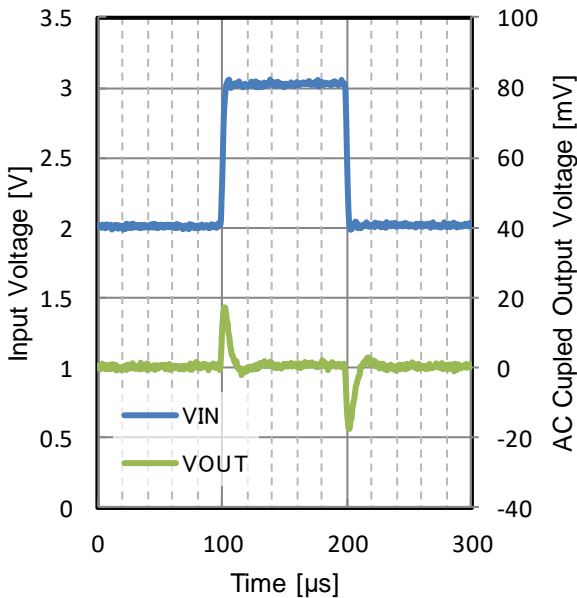

Figure 73. Line Transient
 $V_{OUT} = 1.5\text{ V}$
 $t_R = t_F = 1\text{ V}/\mu\text{s}$, $I_{OUT} = 100\text{ mA}$, $C_{OUT} = 10\text{ }\mu\text{F}$
 $T_j = 85\text{ }^\circ\text{C}$

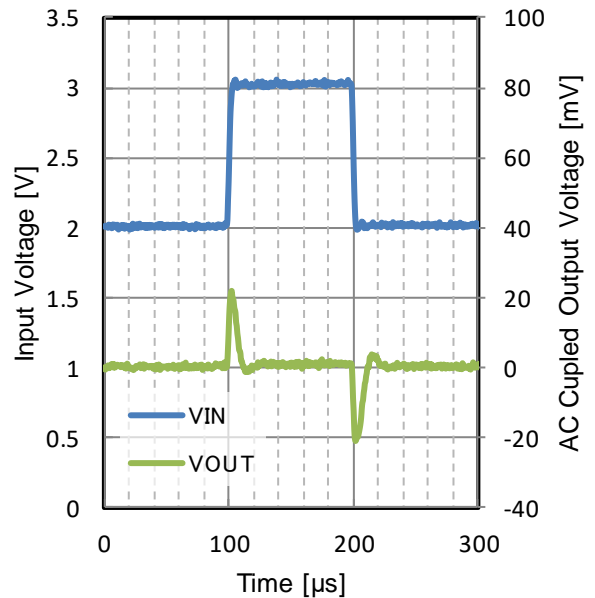

Figure 74. Line Transient
 $V_{OUT} = 1.5\text{ V}$
 $t_R = t_F = 1\text{ V}/\mu\text{s}$, $I_{OUT} = 100\text{ mA}$, $C_{OUT} = 10\text{ }\mu\text{F}$
 $T_j = 150\text{ }^\circ\text{C}$

Typical Performance Curves (BU15JA3DG-C) - continued

Unless otherwise specified, $V_{IN} = 3.0\text{ V}$, $V_{EN} = 1.5\text{ V}$, $C_{IN} = 0.1\text{ }\mu\text{F}$, $C_{OUT} = 1.0\text{ }\mu\text{F}$

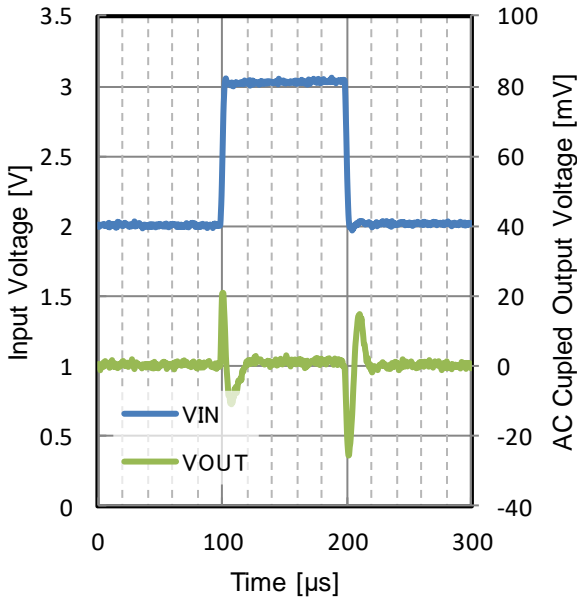

Figure 75. Line Transient
 $V_{OUT} = 1.5\text{ V}$
 $t_R = t_F = 1\text{ V}/\mu\text{s}$, $I_{OUT} = 300\text{ mA}$, $C_{OUT} = 10\text{ }\mu\text{F}$
 $T_j = -40\text{ }^\circ\text{C}$

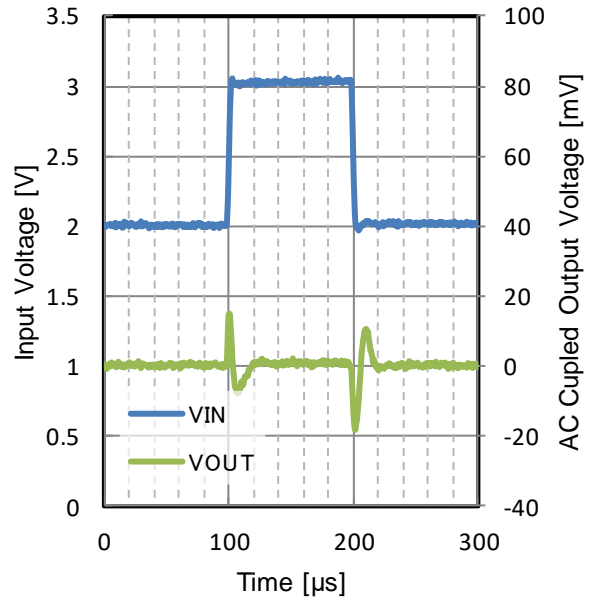

Figure 76. Line Transient
 $V_{OUT} = 1.5\text{ V}$
 $t_R = t_F = 1\text{ V}/\mu\text{s}$, $I_{OUT} = 300\text{ mA}$, $C_{OUT} = 10\text{ }\mu\text{F}$
 $T_j = 25\text{ }^\circ\text{C}$

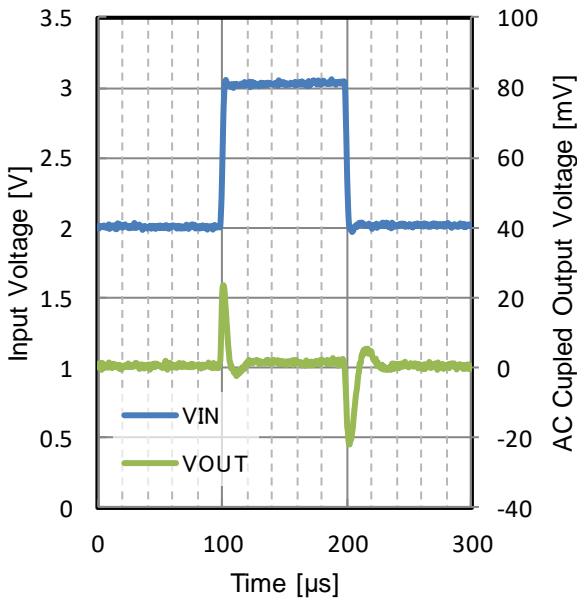

Figure 77. Line Transient
 $V_{OUT} = 1.5\text{ V}$
 $t_R = t_F = 1\text{ V}/\mu\text{s}$, $I_{OUT} = 300\text{ mA}$, $C_{OUT} = 10\text{ }\mu\text{F}$
 $T_j = 85\text{ }^\circ\text{C}$

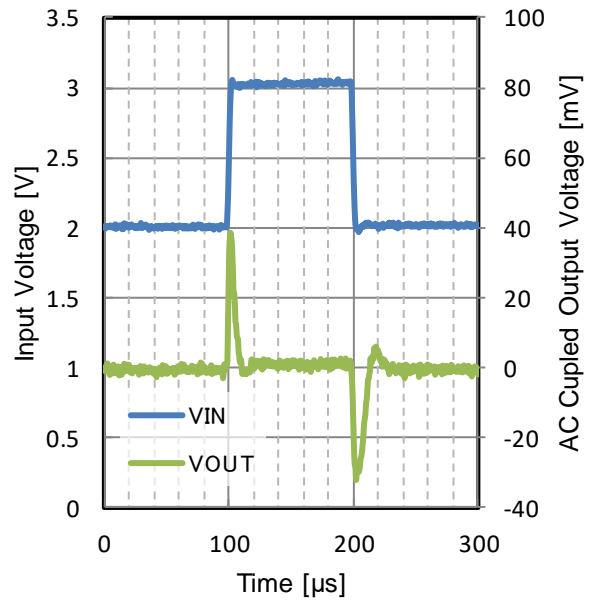

Figure 78. Line Transient
 $V_{OUT} = 1.5\text{ V}$
 $t_R = t_F = 1\text{ V}/\mu\text{s}$, $I_{OUT} = 300\text{ mA}$, $C_{OUT} = 10\text{ }\mu\text{F}$
 $T_j = 150\text{ }^\circ\text{C}$

Typical Performance Curves (BU15JA3DG-C) - continued

Unless otherwise specified, $V_{IN} = 3.0\text{ V}$, $V_{EN} = 1.5\text{ V}$, $C_{IN} = 0.1\text{ }\mu\text{F}$, $C_{OUT} = 1.0\text{ }\mu\text{F}$

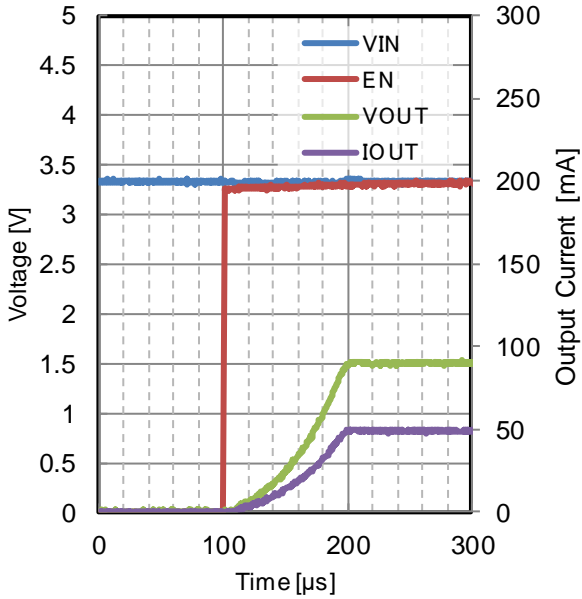

Figure 79. Start Up Waveform
 $V_{OUT} = 1.5\text{ V}$, $I_{OUT} = 50\text{ mA}$
 $V_{IN} = 3.3\text{ V}$, $C_{OUT} = 10\text{ }\mu\text{F}$
 $T_j = -40\text{ }^\circ\text{C}$

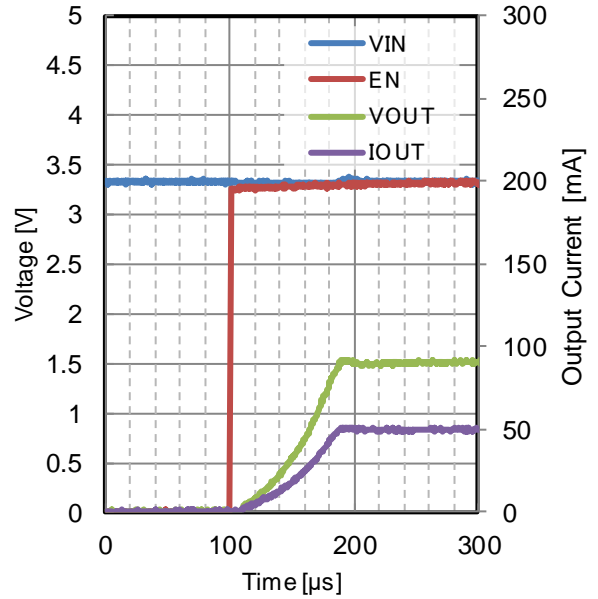

Figure 80. Start Up Waveform
 $V_{OUT} = 1.5\text{ V}$, $I_{OUT} = 50\text{ mA}$
 $V_{IN} = 3.3\text{ V}$, $C_{OUT} = 10\text{ }\mu\text{F}$
 $T_j = 25\text{ }^\circ\text{C}$

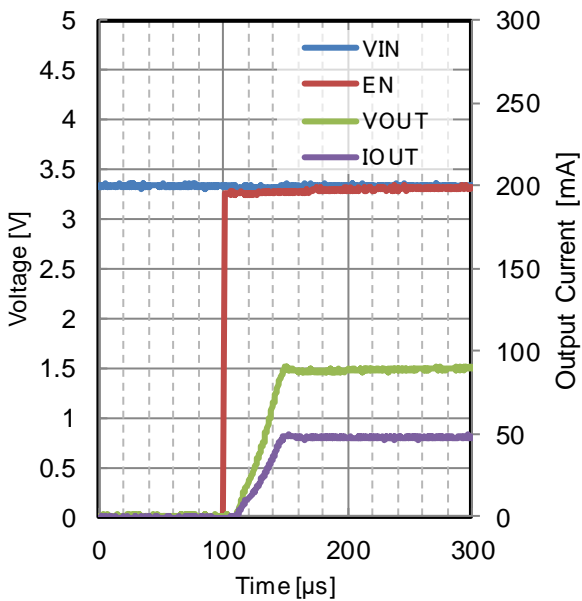

Figure 81. Start Up Waveform
 $V_{OUT} = 1.5\text{ V}$, $I_{OUT} = 50\text{ mA}$
 $V_{IN} = 3.3\text{ V}$, $C_{OUT} = 10\text{ }\mu\text{F}$
 $T_j = 150\text{ }^\circ\text{C}$

Typical Performance Curves (BU15JA3DG-C) - continued

Unless otherwise specified, $V_{IN} = 3.0\text{ V}$, $V_{EN} = 1.5\text{ V}$, $C_{IN} = 0.1\text{ }\mu\text{F}$, $C_{OUT} = 1.0\text{ }\mu\text{F}$

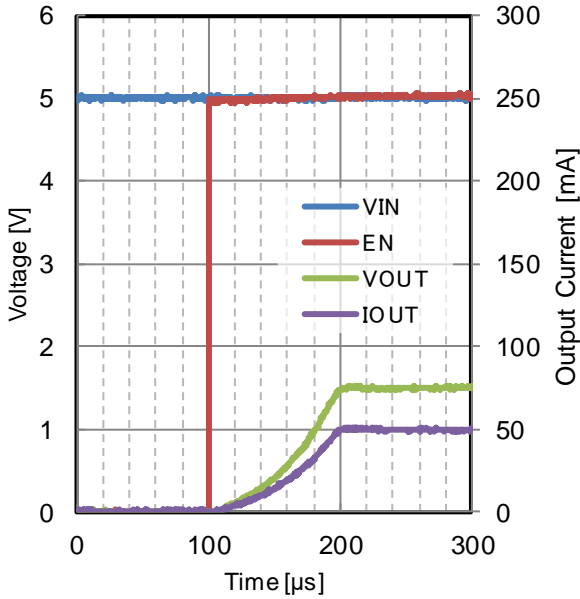

Figure 82. Start Up Waveform
 $V_{OUT} = 1.5\text{ V}$, $I_{OUT} = 50\text{ mA}$
 $V_{IN} = 5.0\text{ V}$, $C_{OUT} = 10\text{ }\mu\text{F}$
 $T_j = -40\text{ }^\circ\text{C}$

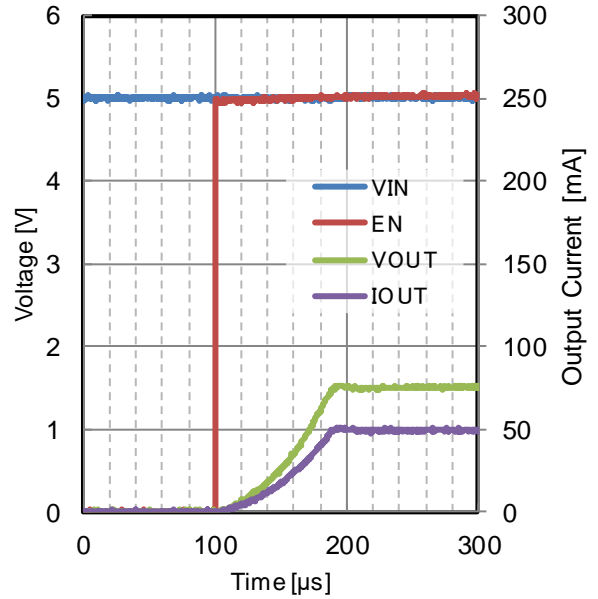

Figure 83. Start Up Waveform
 $V_{OUT} = 1.5\text{ V}$, $I_{OUT} = 50\text{ mA}$
 $V_{IN} = 5.0\text{ V}$, $C_{OUT} = 10\text{ }\mu\text{F}$
 $T_j = 25\text{ }^\circ\text{C}$

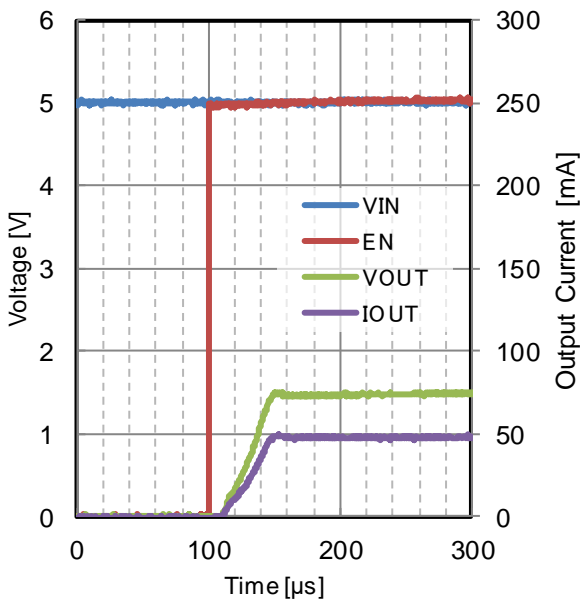

Figure 84. Start Up Waveform
 $V_{OUT} = 1.5\text{ V}$, $I_{OUT} = 50\text{ mA}$
 $V_{IN} = 5.0\text{ V}$, $C_{OUT} = 10\text{ }\mu\text{F}$
 $T_j = 150\text{ }^\circ\text{C}$

Typical Performance Curves (BU18JA3DG-C)

Unless otherwise specified, $V_{IN} = 3.0\text{ V}$, $V_{EN} = 1.5\text{ V}$, $C_{IN} = 0.1\text{ }\mu\text{F}$, $C_{OUT} = 1.0\text{ }\mu\text{F}$

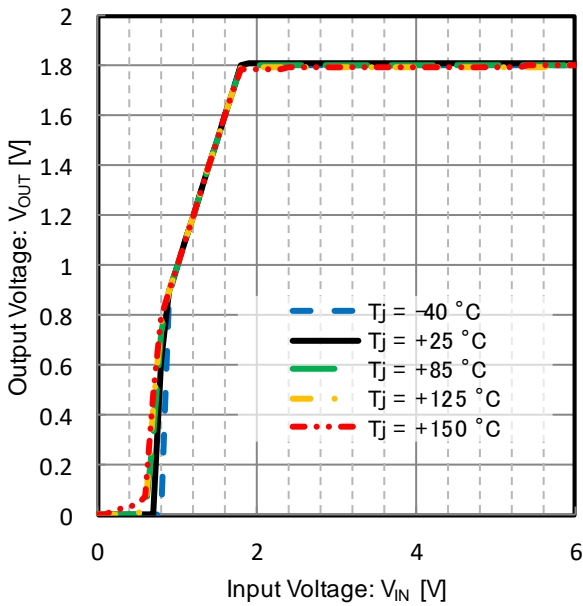

Figure 85. Output Voltage vs Input Voltage
 $V_{OUT} = 1.8\text{ V}$

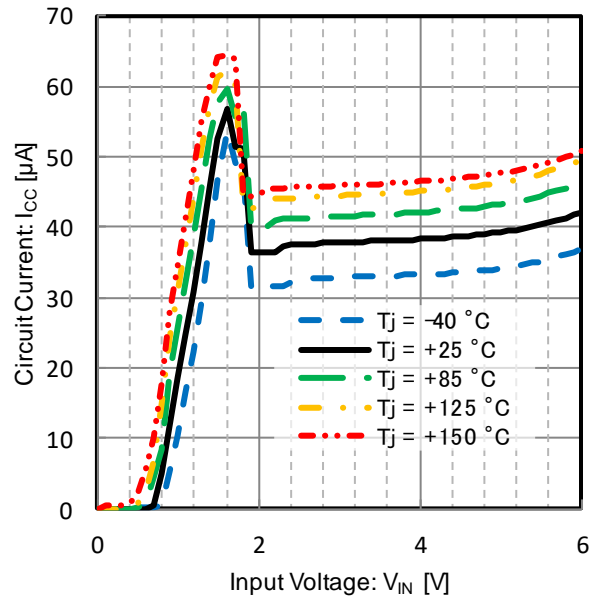

Figure 86. Circuit Current vs Input Voltage
 $V_{OUT} = 1.8\text{ V}$

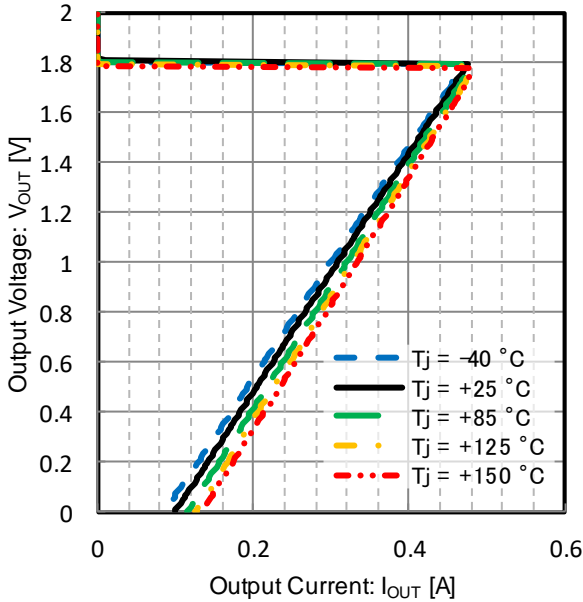

Figure 87. Output Current Limit
 $V_{OUT} = 1.8\text{ V}$

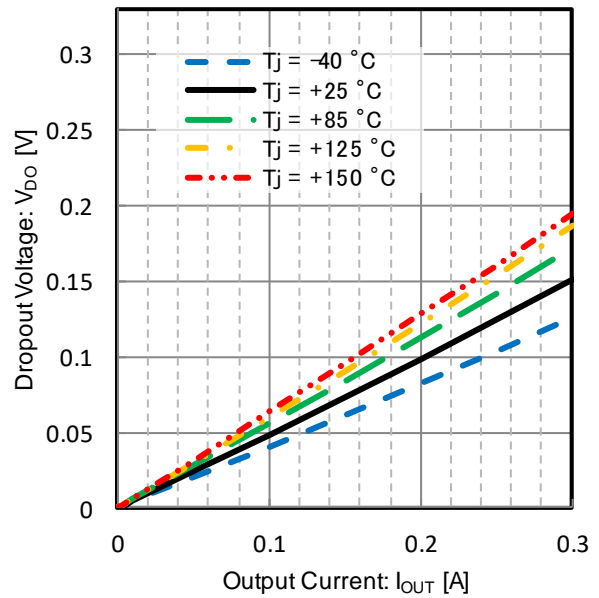

Figure 88. Dropout Voltage vs Output Current
 $V_{IN} = 1.764\text{ V}$, $V_{OUT} = 1.8\text{ V}$

Typical Performance Curves (BU18JA3DG-C) - continued

Unless otherwise specified, $V_{IN} = 3.0\text{ V}$, $V_{EN} = 1.5\text{ V}$, $C_{IN} = 0.1\text{ }\mu\text{F}$, $C_{OUT} = 1.0\text{ }\mu\text{F}$

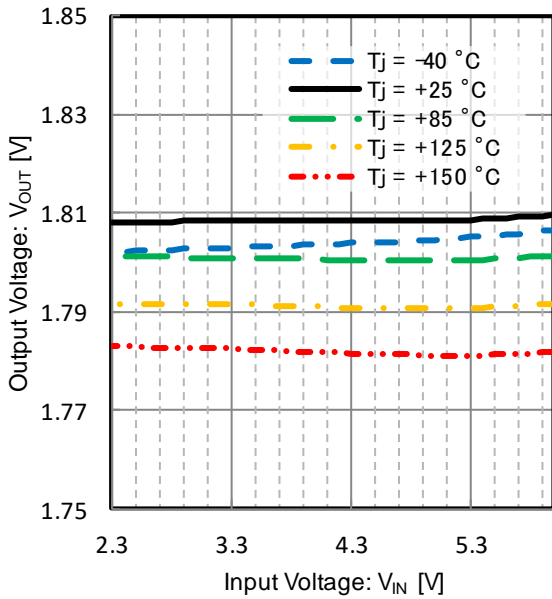

Figure 89. Line Regulation
 $V_{OUT} = 1.8\text{ V}$, $I_{OUT} = 50\text{ mA}$

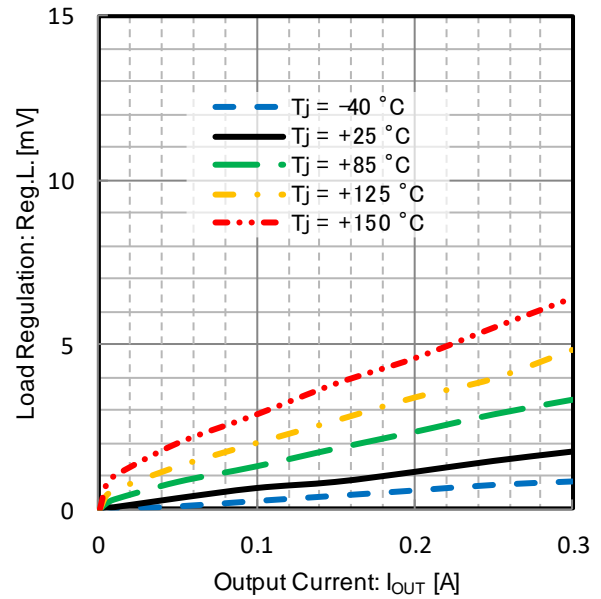

Figure 90. Load Regulation
 $V_{OUT} = 1.8\text{ V}$, $I_{OUT} = 1\text{ mA to } 300\text{ mA}$

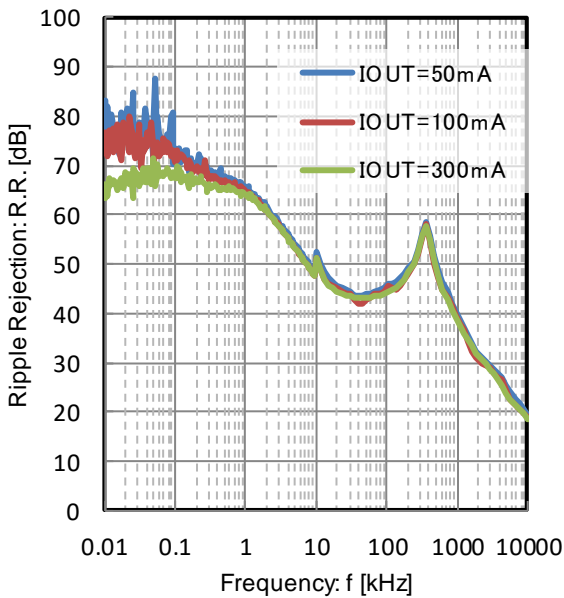

Figure 91. PSRR vs Frequency and Output Current
 $C_{IN} = 0\text{ }\mu\text{F}$, $C_{OUT} = 10\text{ }\mu\text{F}$
 $V_{OUT} = 1.8\text{ V}$

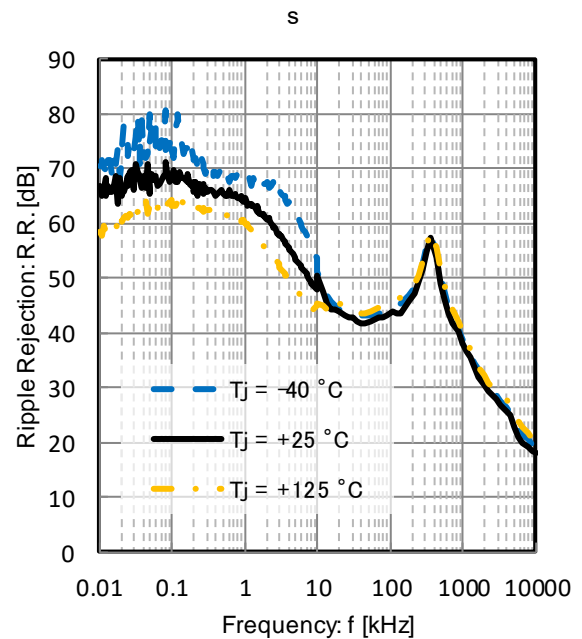

Figure 92. PSRR vs Frequency and Temperature
 $C_{IN} = 0\text{ }\mu\text{F}$, $C_{OUT} = 10\text{ }\mu\text{F}$
 $V_{IN} = 5\text{ V}$, $V_{OUT} = 1.8\text{ V}$, $I_{OUT} = 300\text{ mA}$

Typical Performance Curves (BU18JA3DG-C) - continued

Unless otherwise specified, $V_{IN} = 3.0\text{ V}$, $V_{EN} = 1.5\text{ V}$, $C_{IN} = 0.1\text{ }\mu\text{F}$, $C_{OUT} = 1.0\text{ }\mu\text{F}$

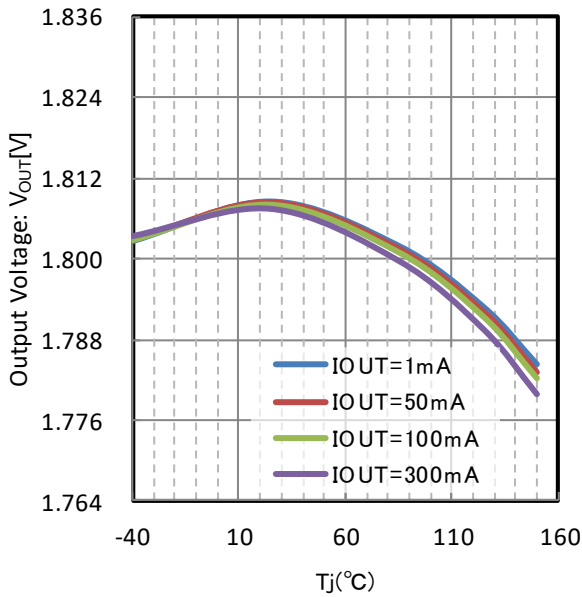

Figure 93. Output Voltage vs Junction temperature
 $V_{OUT} = 1.8\text{ V}$

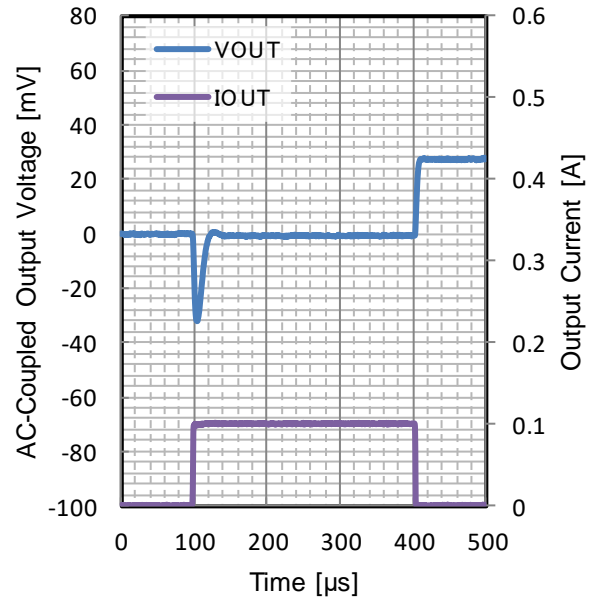

Figure 94. Load Transient
 $V_{OUT} = 1.8\text{ V}$
 $t_R = t_F = 1\text{ }\mu\text{s}$, $I_{OUT} = 0\text{ mA to }100\text{ mA}$, $C_{OUT} = 10\text{ }\mu\text{F}$
 $T_j = -40\text{ }^\circ\text{C}$

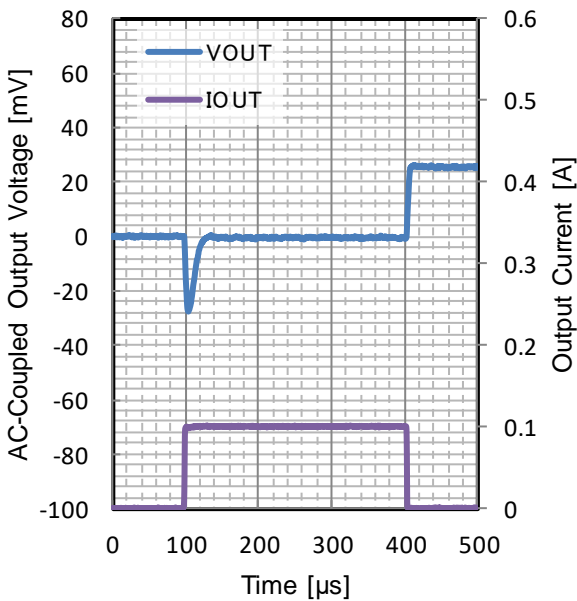

Figure 95. Load Transient
 $V_{OUT} = 1.8\text{ V}$
 $t_R = t_F = 1\text{ }\mu\text{s}$, $I_{OUT} = 0\text{ mA to }100\text{ mA}$, $C_{OUT} = 10\text{ }\mu\text{F}$
 $T_j = 25\text{ }^\circ\text{C}$

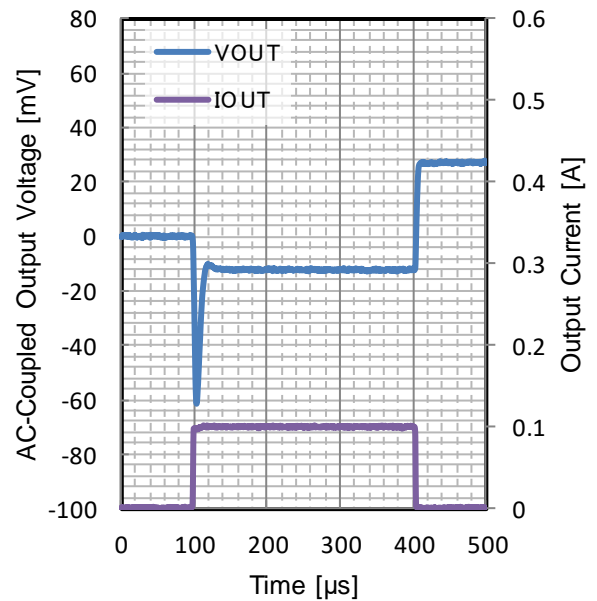

Figure 96. Load Transient
 $V_{OUT} = 1.8\text{ V}$
 $t_R = t_F = 1\text{ }\mu\text{s}$, $I_{OUT} = 0\text{ mA to }100\text{ mA}$, $C_{OUT} = 10\text{ }\mu\text{F}$
 $T_j = 150\text{ }^\circ\text{C}$

Typical Performance Curves (BU18JA3DG-C) - continued

Unless otherwise specified, $V_{IN} = 3.0\text{ V}$, $V_{EN} = 1.5\text{ V}$, $C_{IN} = 0.1\text{ }\mu\text{F}$, $C_{OUT} = 1.0\text{ }\mu\text{F}$

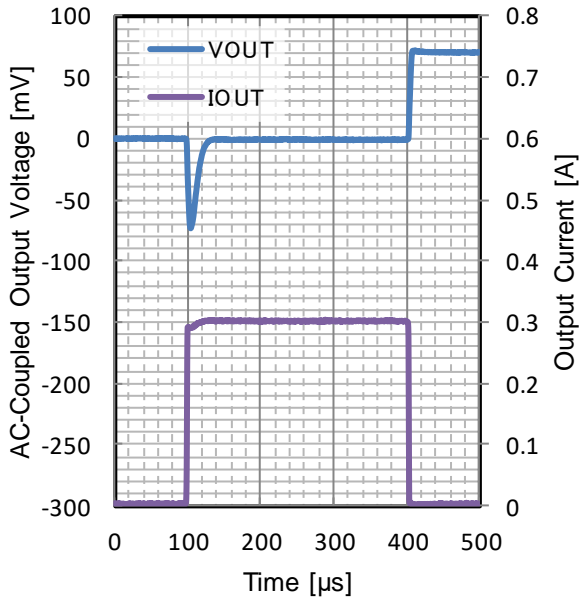

Figure 97. Load Transient

$V_{OUT} = 1.8\text{ V}$

$t_R = t_F = 1\text{ }\mu\text{s}$, $I_{OUT} = 0\text{ mA to }300\text{ mA}$, $C_{OUT} = 10\text{ }\mu\text{F}$
 $T_j = -40\text{ }^\circ\text{C}$

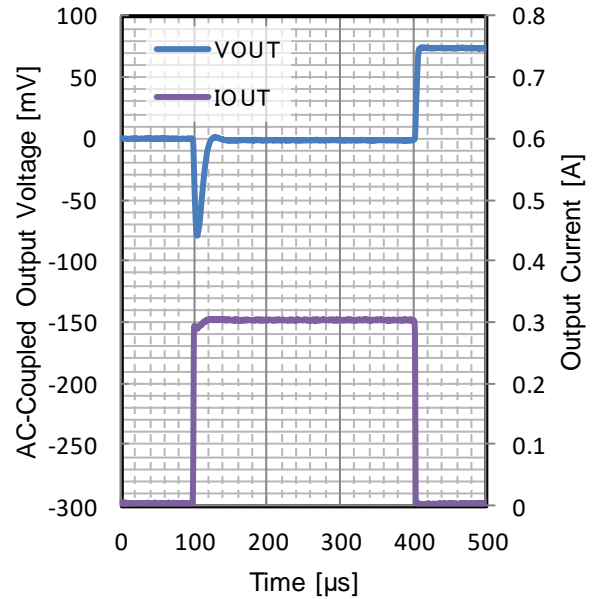

Figure 98. Load Transient

$V_{OUT} = 1.8\text{ V}$

$t_R = t_F = 1\text{ }\mu\text{s}$, $I_{OUT} = 0\text{ mA to }300\text{ mA}$, $C_{OUT} = 10\text{ }\mu\text{F}$
 $T_j = 25\text{ }^\circ\text{C}$

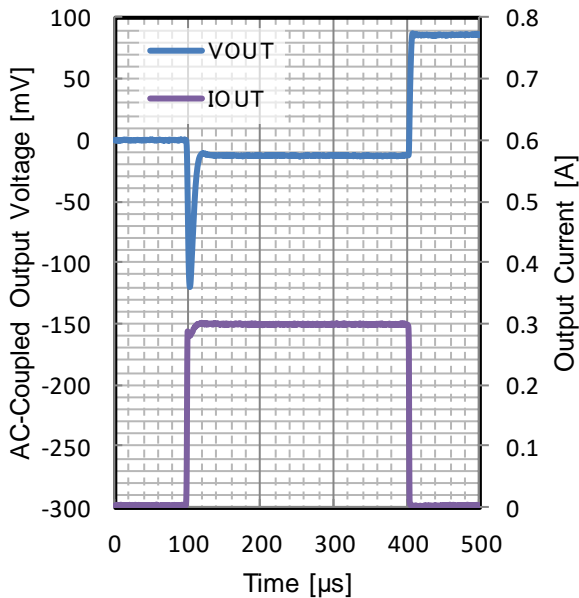

Figure 99. Load Transient

$V_{OUT} = 1.8\text{ V}$

$t_R = t_F = 1\text{ }\mu\text{s}$, $I_{OUT} = 0\text{ mA to }300\text{ mA}$, $C_{OUT} = 10\text{ }\mu\text{F}$
 $T_j = 150\text{ }^\circ\text{C}$

Typical Performance Curves (BU18JA3DG-C) - continued

Unless otherwise specified, $V_{IN} = 3.0\text{ V}$, $V_{EN} = 1.5\text{ V}$, $C_{IN} = 0.1\text{ }\mu\text{F}$, $C_{OUT} = 1.0\text{ }\mu\text{F}$

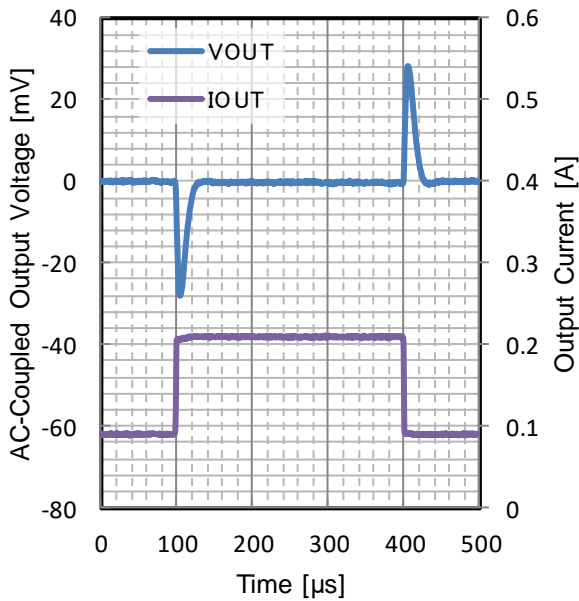

Figure 100. Load Transient

$V_{OUT} = 1.8\text{ V}$

$t_r = t_f = 1\text{ }\mu\text{s}$, $I_{OUT} = 90\text{ mA to }210\text{ mA}$, $C_{OUT} = 10\text{ }\mu\text{F}$
 $T_j = -40\text{ }^\circ\text{C}$

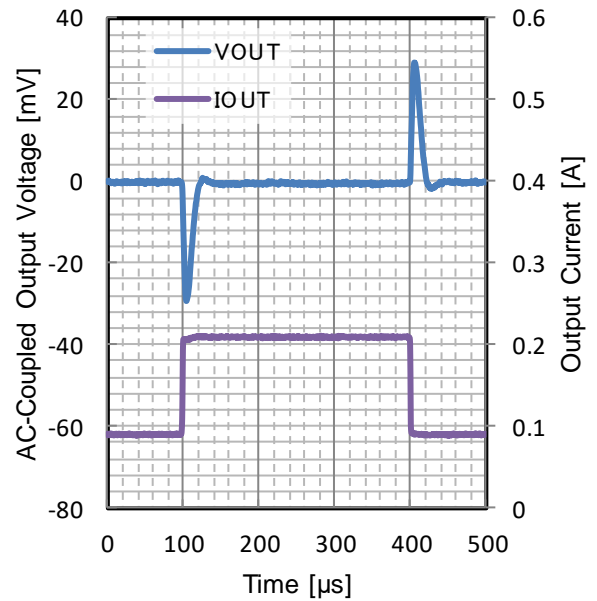

Figure 101. Load Transient

$V_{OUT} = 1.8\text{ V}$

$t_r = t_f = 1\text{ }\mu\text{s}$, $I_{OUT} = 90\text{ mA to }210\text{ mA}$, $C_{OUT} = 10\text{ }\mu\text{F}$
 $T_j = 25\text{ }^\circ\text{C}$

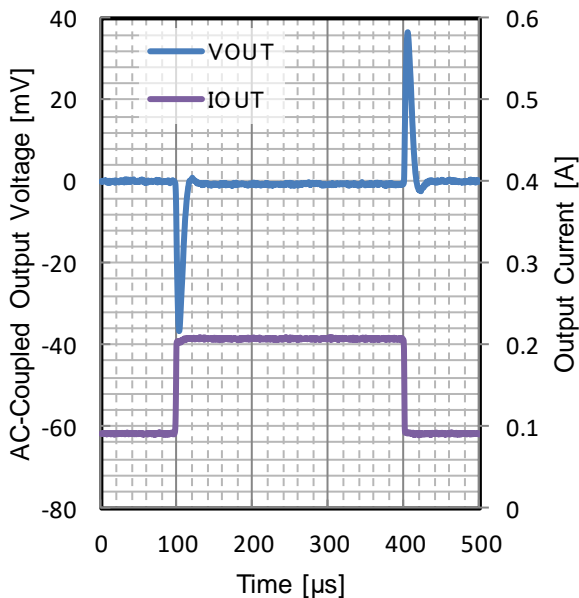

Figure 102. Load Transient

$V_{OUT} = 1.8\text{ V}$

$t_r = t_f = 1\text{ }\mu\text{s}$, $I_{OUT} = 90\text{ mA to }210\text{ mA}$, $C_{OUT} = 10\text{ }\mu\text{F}$
 $T_j = 150\text{ }^\circ\text{C}$

Typical Performance Curves (BU18JA3DG-C) - continued

Unless otherwise specified, $V_{IN} = 3.0\text{ V}$, $V_{EN} = 1.5\text{ V}$, $C_{IN} = 0.1\text{ }\mu\text{F}$, $C_{OUT} = 1.0\text{ }\mu\text{F}$

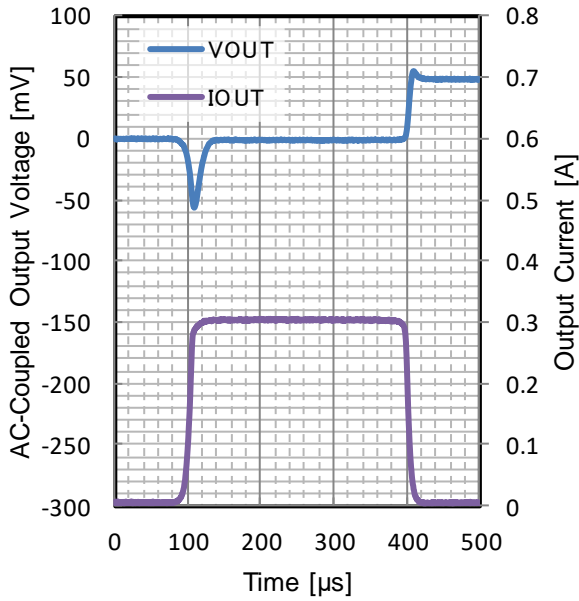

Figure 103. Load Transient

$V_{OUT} = 1.8\text{ V}$

$t_{r} = t_{f} = 10\text{ }\mu\text{s}$, $I_{OUT} = 0\text{ mA to }300\text{ mA}$, $C_{OUT} = 10\text{ }\mu\text{F}$
 $T_j = -40\text{ }^{\circ}\text{C}$

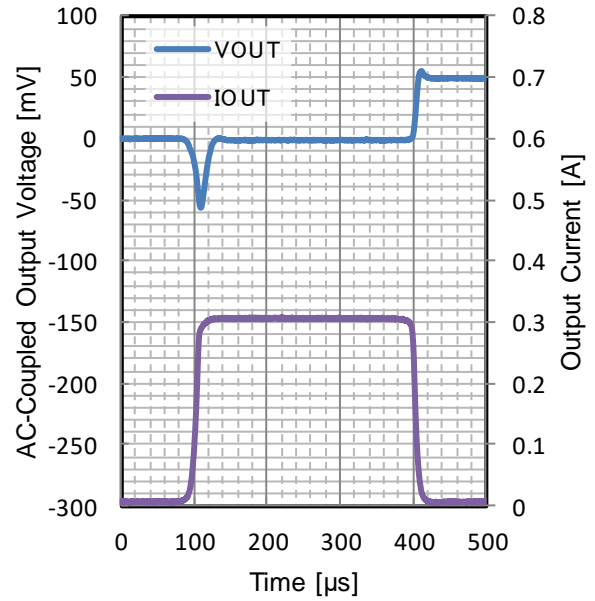

Figure 104. Load Transient

$V_{OUT} = 1.8\text{ V}$

$t_{r} = t_{f} = 10\text{ }\mu\text{s}$, $I_{OUT} = 0\text{ mA to }300\text{ mA}$, $C_{OUT} = 10\text{ }\mu\text{F}$
 $T_j = 25\text{ }^{\circ}\text{C}$

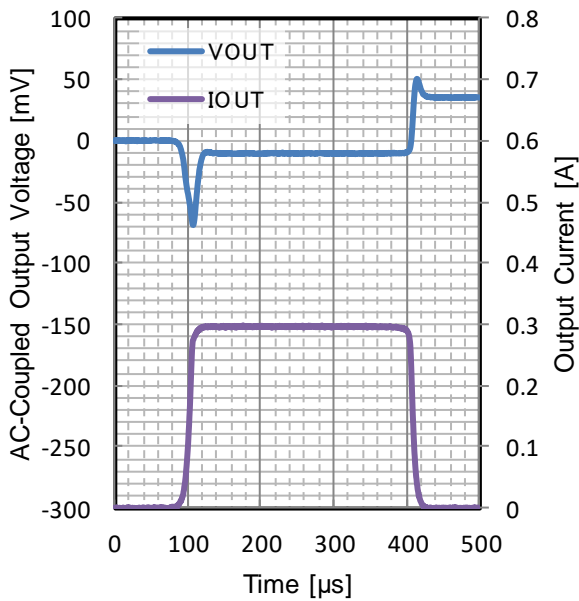

Figure 105. Load Transient

$V_{OUT} = 1.8\text{ V}$

$t_{r} = t_{f} = 10\text{ }\mu\text{s}$, $I_{OUT} = 0\text{ mA to }300\text{ mA}$, $C_{OUT} = 10\text{ }\mu\text{F}$
 $T_j = 150\text{ }^{\circ}\text{C}$

Typical Performance Curves (BU18JA3DG-C) - continued

Unless otherwise specified, $V_{IN} = 3.0\text{ V}$, $V_{EN} = 1.5\text{ V}$, $C_{IN} = 0.1\text{ }\mu\text{F}$, $C_{OUT} = 1.0\text{ }\mu\text{F}$

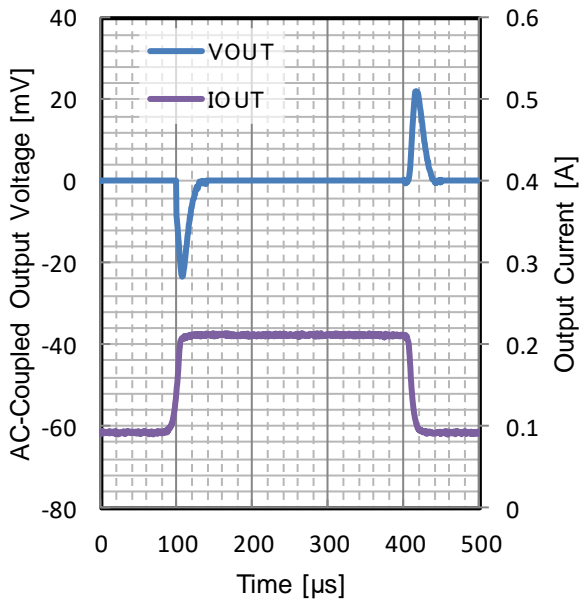

Figure 106. Load Transient

$V_{OUT} = 1.8\text{ V}$

$t_R = t_F = 10\text{ }\mu\text{s}$, $I_{OUT} = 90\text{ mA to }210\text{ mA}$, $C_{OUT} = 10\text{ }\mu\text{F}$
 $T_j = -40\text{ }^\circ\text{C}$

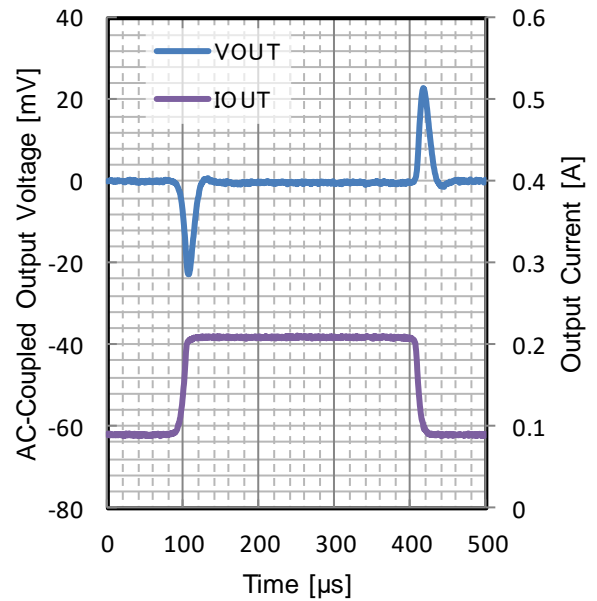

Figure 107. Load Transient

$V_{OUT} = 1.8\text{ V}$

$t_R = t_F = 10\text{ }\mu\text{s}$, $I_{OUT} = 90\text{ mA to }210\text{ mA}$, $C_{OUT} = 10\text{ }\mu\text{F}$
 $T_j = 25\text{ }^\circ\text{C}$

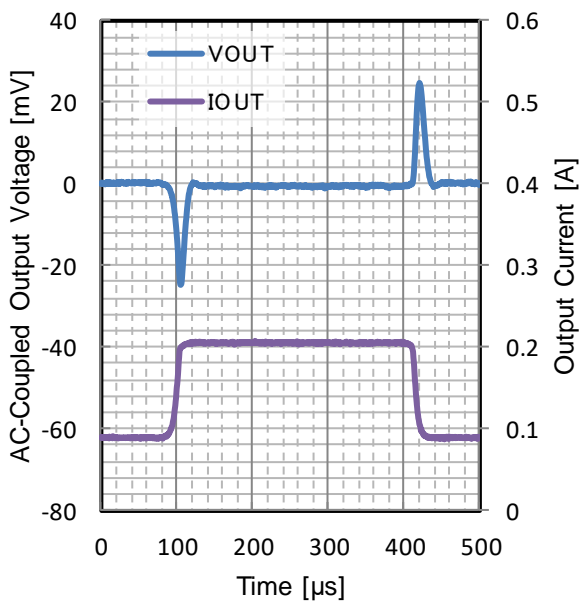

Figure 108. Load Transient

$V_{OUT} = 1.8\text{ V}$

$t_R = t_F = 10\text{ }\mu\text{s}$, $I_{OUT} = 90\text{ mA to }210\text{ mA}$, $C_{OUT} = 10\text{ }\mu\text{F}$
 $T_j = 150\text{ }^\circ\text{C}$

Typical Performance Curves (BU18JA3DG-C) - continued

Unless otherwise specified, $V_{IN} = 3.0\text{ V}$, $V_{EN} = 1.5\text{ V}$, $C_{IN} = 0.1\text{ }\mu\text{F}$, $C_{OUT} = 1.0\text{ }\mu\text{F}$

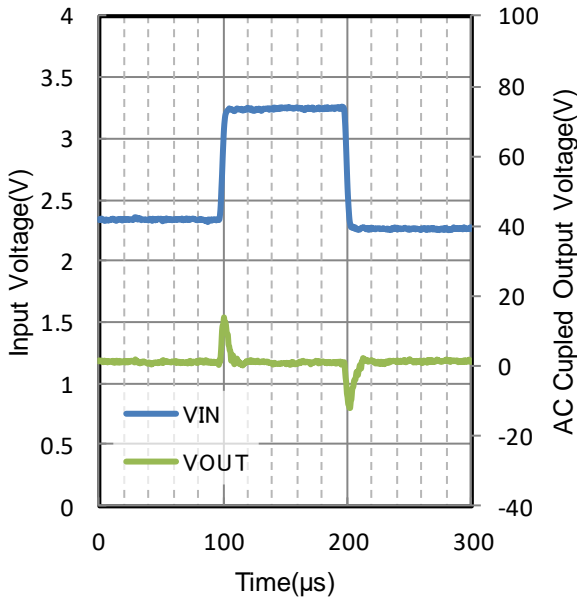

Figure 109. Line Transient
 $V_{OUT} = 1.8\text{ V}$
 $t_R = t_F = 1\text{ V}/\mu\text{s}$, $I_{OUT} = 50\text{ mA}$, $C_{OUT} = 10\text{ }\mu\text{F}$
 $T_j = -40\text{ }^\circ\text{C}$

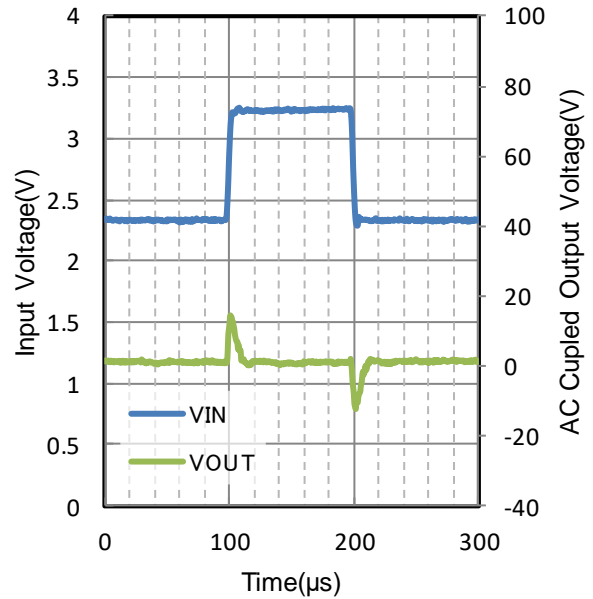

Figure 110. Line Transient
 $V_{OUT} = 1.8\text{ V}$
 $t_R = t_F = 1\text{ V}/\mu\text{s}$, $I_{OUT} = 50\text{ mA}$, $C_{OUT} = 10\text{ }\mu\text{F}$
 $T_j = 25\text{ }^\circ\text{C}$

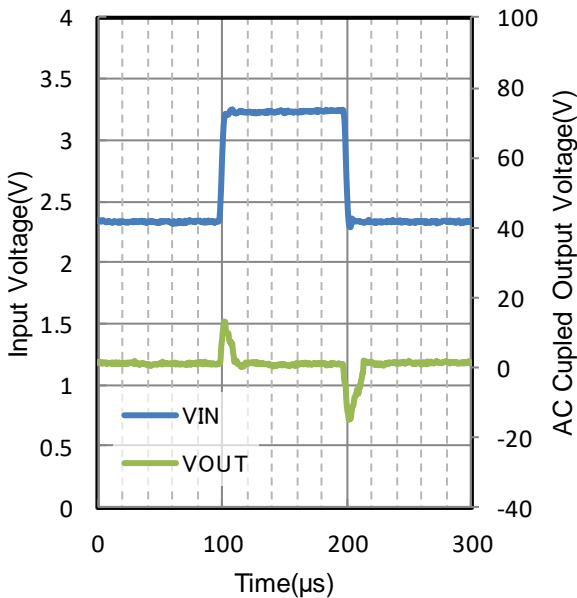

Figure 111. Line Transient
 $V_{OUT} = 1.8\text{ V}$
 $t_R = t_F = 1\text{ V}/\mu\text{s}$, $I_{OUT} = 50\text{ mA}$, $C_{OUT} = 10\text{ }\mu\text{F}$
 $T_j = 85\text{ }^\circ\text{C}$

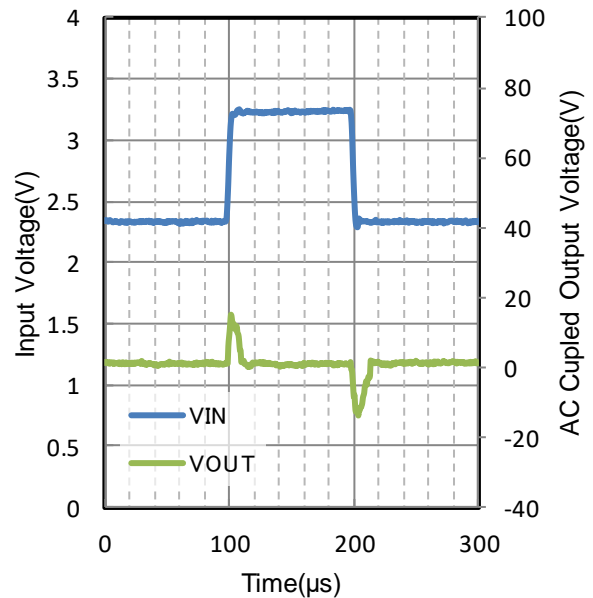

Figure 112. Line Transient
 $V_{OUT} = 1.8\text{ V}$
 $t_R = t_F = 1\text{ V}/\mu\text{s}$, $I_{OUT} = 50\text{ mA}$, $C_{OUT} = 10\text{ }\mu\text{F}$
 $T_j = 150\text{ }^\circ\text{C}$

Typical Performance Curves (BU18JA3DG-C) - continued

Unless otherwise specified, $V_{IN} = 3.0\text{ V}$, $V_{EN} = 1.5\text{ V}$, $C_{IN} = 0.1\text{ }\mu\text{F}$, $C_{OUT} = 1.0\text{ }\mu\text{F}$

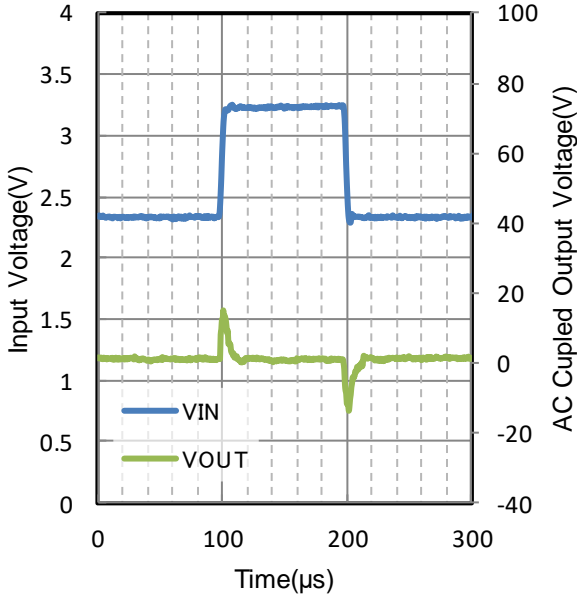

Figure 113. Line Transient
 $V_{OUT} = 1.8\text{ V}$
 $t_R = t_F = 1\text{ V}/\mu\text{s}$, $I_{OUT} = 100\text{ mA}$, $C_{OUT} = 10\text{ }\mu\text{F}$
 $T_j = -40\text{ }^\circ\text{C}$

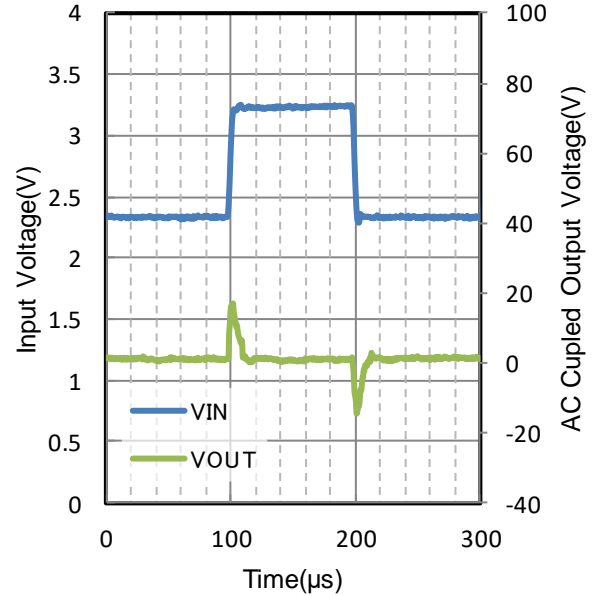

Figure 114. Line Transient
 $V_{OUT} = 1.8\text{ V}$
 $t_R = t_F = 1\text{ V}/\mu\text{s}$, $I_{OUT} = 100\text{ mA}$, $C_{OUT} = 10\text{ }\mu\text{F}$
 $T_j = 25\text{ }^\circ\text{C}$

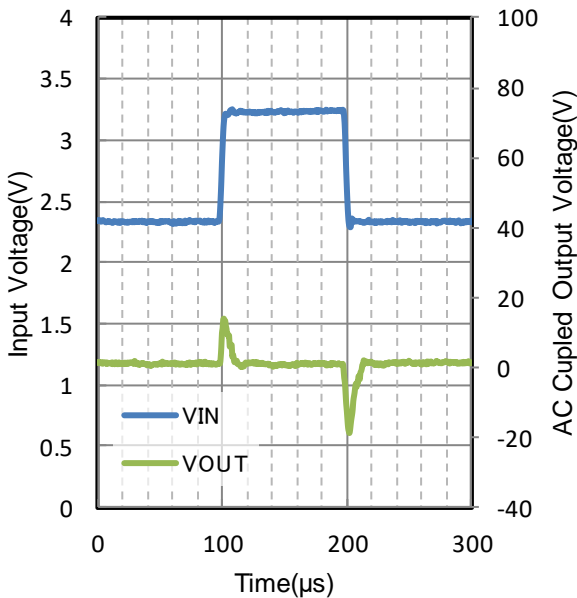

Figure 115. Line Transient
 $V_{OUT} = 1.8\text{ V}$
 $t_R = t_F = 1\text{ V}/\mu\text{s}$, $I_{OUT} = 100\text{ mA}$, $C_{OUT} = 10\text{ }\mu\text{F}$
 $T_j = 85\text{ }^\circ\text{C}$

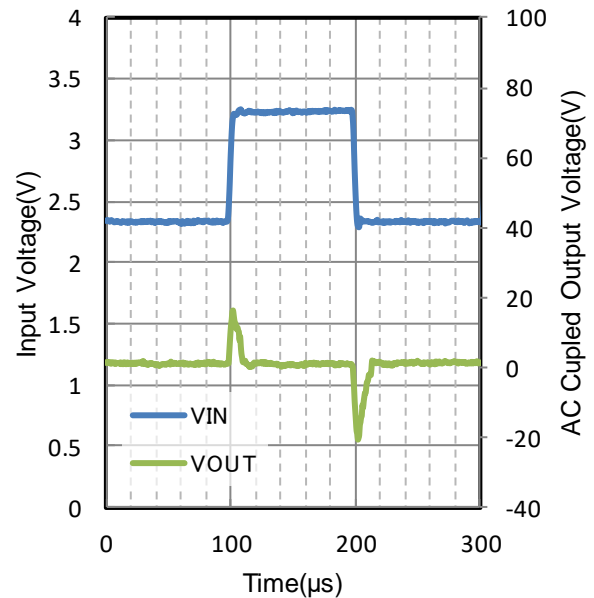

Figure 116. Line Transient
 $V_{OUT} = 1.8\text{ V}$
 $t_R = t_F = 1\text{ V}/\mu\text{s}$, $I_{OUT} = 100\text{ mA}$, $C_{OUT} = 10\text{ }\mu\text{F}$
 $T_j = 150\text{ }^\circ\text{C}$

Typical Performance Curves (BU18JA3DG-C) - continued

Unless otherwise specified, $V_{IN} = 3.0\text{ V}$, $V_{EN} = 1.5\text{ V}$, $C_{IN} = 0.1\text{ }\mu\text{F}$, $C_{OUT} = 1.0\text{ }\mu\text{F}$

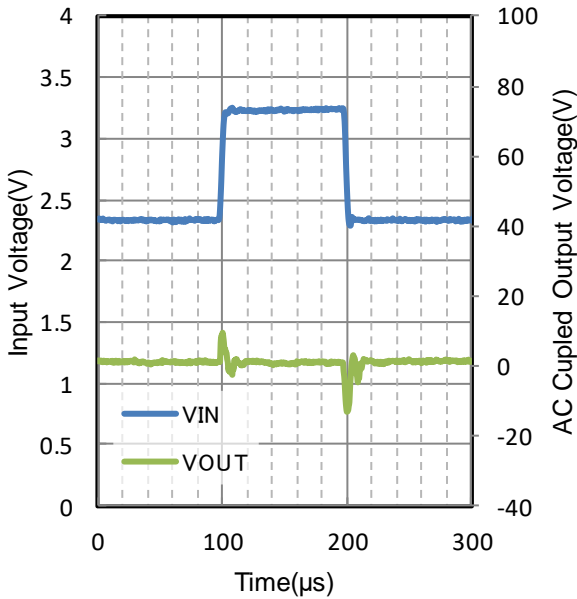

Figure 117. Line Transient

$V_{OUT} = 1.8\text{ V}$

$t_R = t_F = 1\text{ V}/\mu\text{s}$, $I_{OUT} = 300\text{ mA}$, $C_{OUT} = 10\text{ }\mu\text{F}$
 $T_j = -40\text{ }^\circ\text{C}$

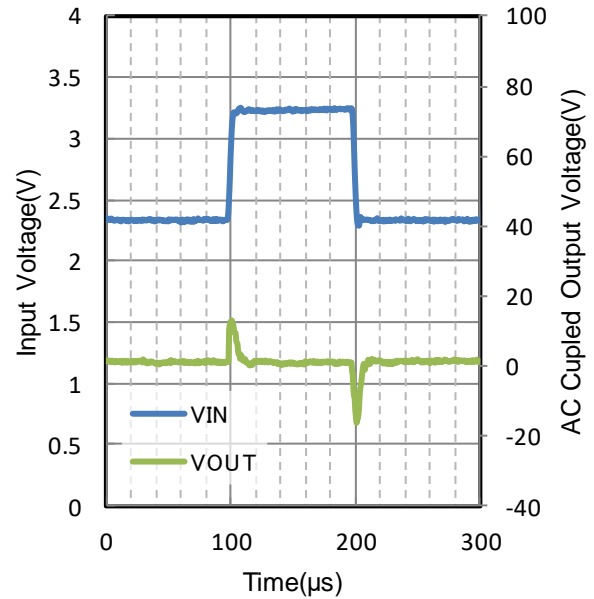

Figure 118. Line Transient

$V_{OUT} = 1.8\text{ V}$

$t_R = t_F = 1\text{ V}/\mu\text{s}$, $I_{OUT} = 300\text{ mA}$, $C_{OUT} = 10\text{ }\mu\text{F}$
 $T_j = 25\text{ }^\circ\text{C}$

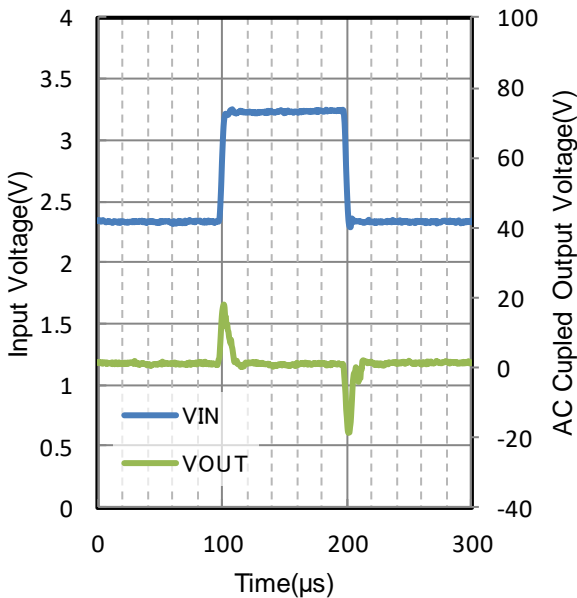

Figure 119. Line Transient

$V_{OUT} = 1.8\text{ V}$

$t_R = t_F = 1\text{ V}/\mu\text{s}$, $I_{OUT} = 300\text{ mA}$, $C_{OUT} = 10\text{ }\mu\text{F}$
 $T_j = 85\text{ }^\circ\text{C}$

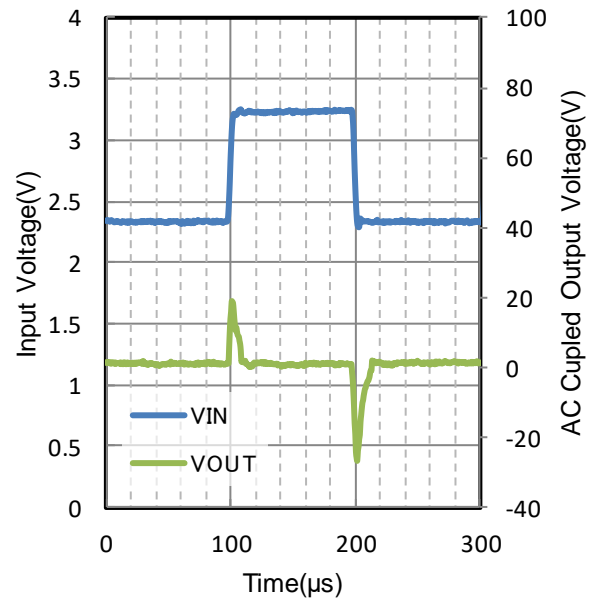

Figure 120. Line Transient

$V_{OUT} = 1.8\text{ V}$

$t_R = t_F = 1\text{ V}/\mu\text{s}$, $I_{OUT} = 300\text{ mA}$, $C_{OUT} = 10\text{ }\mu\text{F}$
 $T_j = 150\text{ }^\circ\text{C}$

Typical Performance Curves (BU18JA3DG-C) - continued

Unless otherwise specified, $V_{IN} = 3.0\text{ V}$, $V_{EN} = 1.5\text{ V}$, $C_{IN} = 0.1\ \mu\text{F}$, $C_{OUT} = 1.0\ \mu\text{F}$

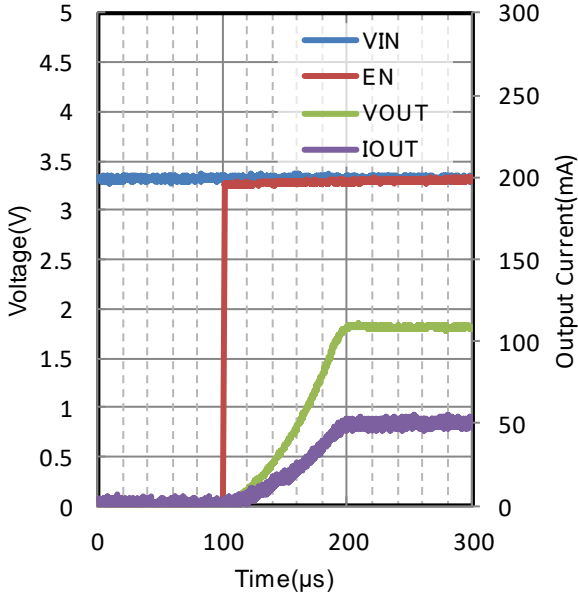

Figure 121. Start Up Waveform
 $V_{OUT} = 1.8\text{ V}$, $I_{OUT} = 50\text{ mA}$
 $V_{IN} = 3.3\text{ V}$, $C_{OUT} = 10\ \mu\text{F}$
 $T_j = -40\text{ }^\circ\text{C}$

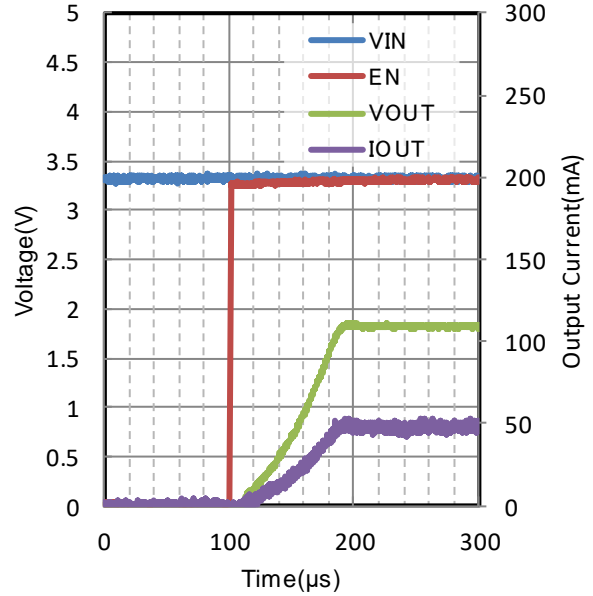

Figure 122. Start Up Waveform
 $V_{OUT} = 1.8\text{ V}$, $I_{OUT} = 50\text{ mA}$
 $V_{IN} = 3.3\text{ V}$, $C_{OUT} = 10\ \mu\text{F}$
 $T_j = 25\text{ }^\circ\text{C}$

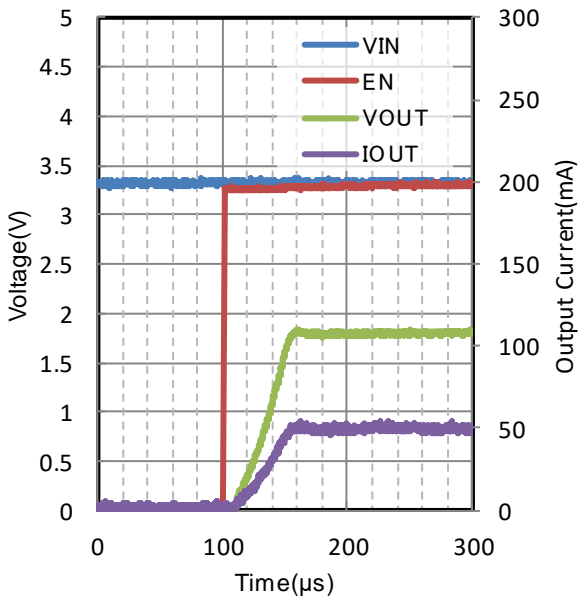

Figure 123. Start Up Waveform
 $V_{OUT} = 1.8\text{ V}$, $I_{OUT} = 50\text{ mA}$
 $V_{IN} = 3.3\text{ V}$, $C_{OUT} = 10\ \mu\text{F}$
 $T_j = 150\text{ }^\circ\text{C}$

Typical Performance Curves (BU18JA3DG-C) - continued

Unless otherwise specified, $V_{IN} = 3.0\text{ V}$, $V_{EN} = 1.5\text{ V}$, $C_{IN} = 0.1\text{ }\mu\text{F}$, $C_{OUT} = 1.0\text{ }\mu\text{F}$

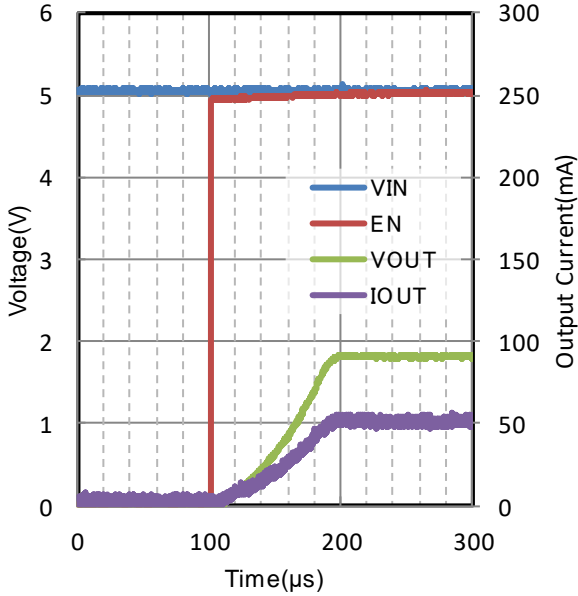

Figure 124. Start Up Waveform
 $V_{OUT} = 1.8\text{ V}$, $I_{OUT} = 50\text{ mA}$
 $V_{IN} = 5.0\text{ V}$, $C_{OUT} = 10\text{ }\mu\text{F}$
 $T_j = -40\text{ }^\circ\text{C}$

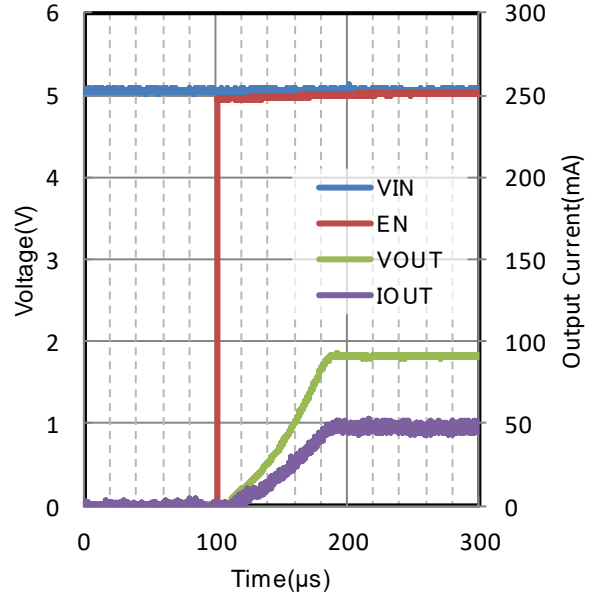

Figure 125. Start Up Waveform
 $V_{OUT} = 1.8\text{ V}$, $I_{OUT} = 50\text{ mA}$
 $V_{IN} = 5.0\text{ V}$, $C_{OUT} = 10\text{ }\mu\text{F}$
 $T_j = 25\text{ }^\circ\text{C}$

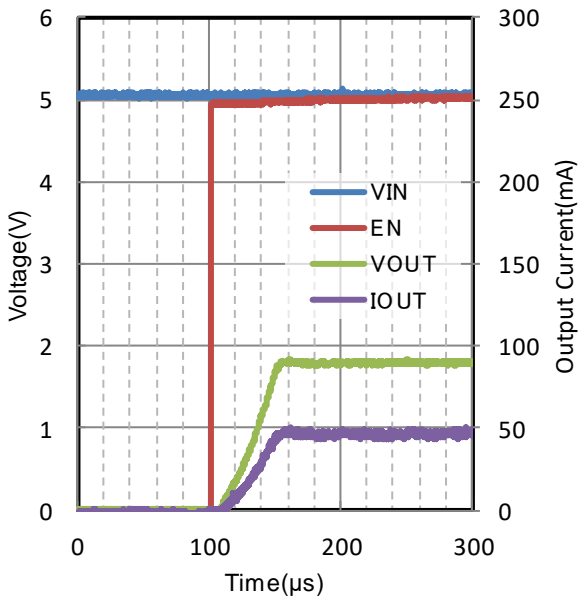

Figure 126. Start Up Waveform
 $V_{OUT} = 1.8\text{ V}$, $I_{OUT} = 50\text{ mA}$
 $V_{IN} = 5.0\text{ V}$, $C_{OUT} = 10\text{ }\mu\text{F}$
 $T_j = 150\text{ }^\circ\text{C}$

Typical Performance Curves (BU25JA3DG-C)

Unless otherwise specified, $V_{IN} = 3.5\text{ V}$, $V_{EN} = 1.5\text{ V}$, $C_{IN} = 0.1\text{ }\mu\text{F}$, $C_{OUT} = 1.0\text{ }\mu\text{F}$

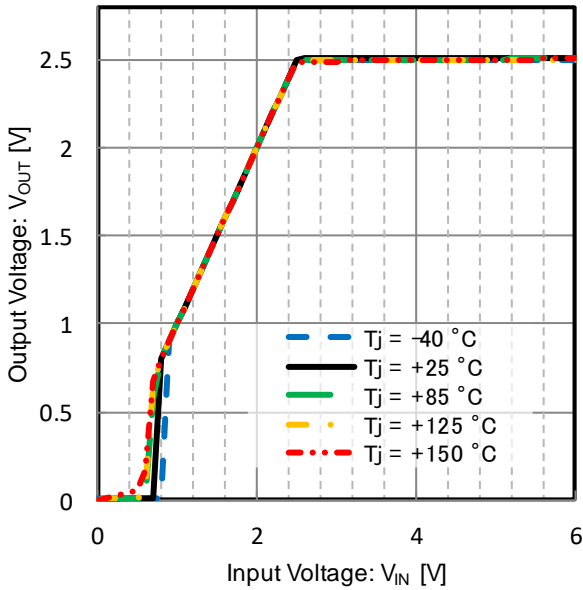

Figure 127. Output Voltage vs Input Voltage
 $V_{OUT} = 2.5\text{ V}$

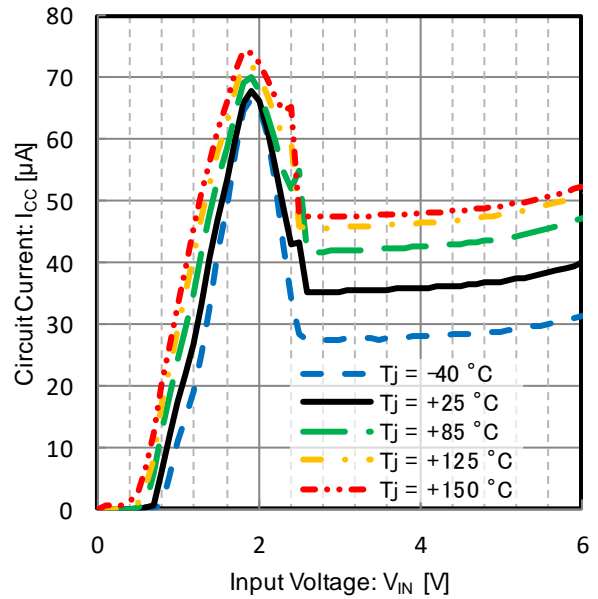

Figure 128. Circuit Current vs Input Voltage
 $V_{OUT} = 2.5\text{ V}$

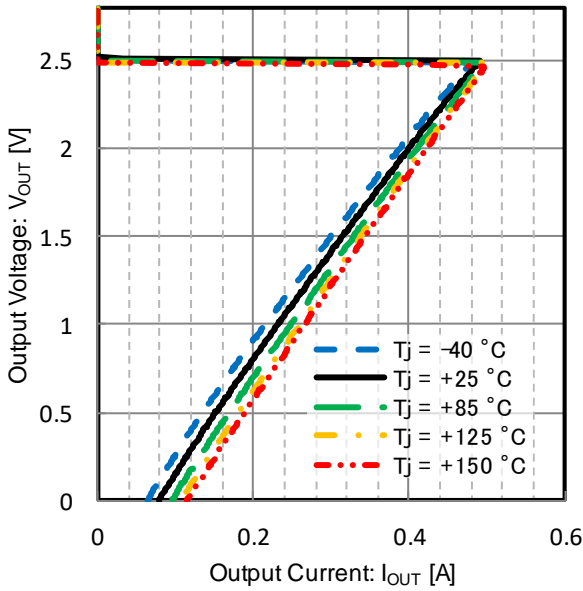

Figure 129. Output Current Limit
 $V_{OUT} = 2.5\text{ V}$

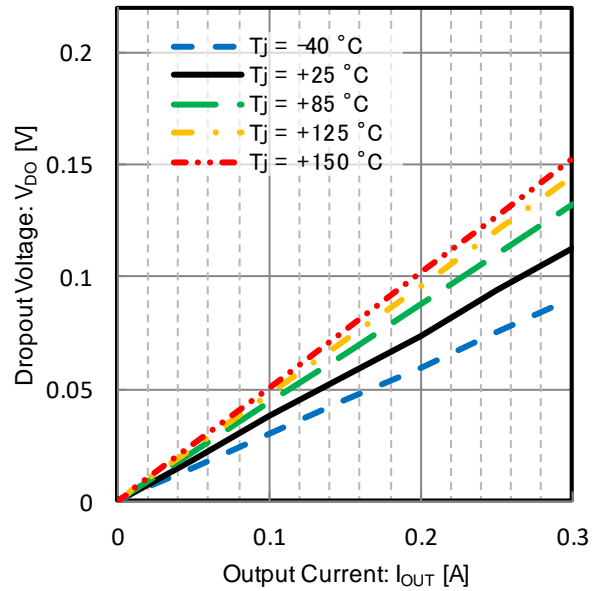

Figure 130. Dropout Voltage vs Output Current
 $V_{IN} = 2.45\text{ V}$, $V_{OUT} = 2.5\text{ V}$

Typical Performance Curves (BU25JA3DG-C) - continued

Unless otherwise specified, $V_{IN} = 3.5\text{ V}$, $V_{EN} = 1.5\text{ V}$, $C_{IN} = 0.1\text{ }\mu\text{F}$, $C_{OUT} = 1.0\text{ }\mu\text{F}$

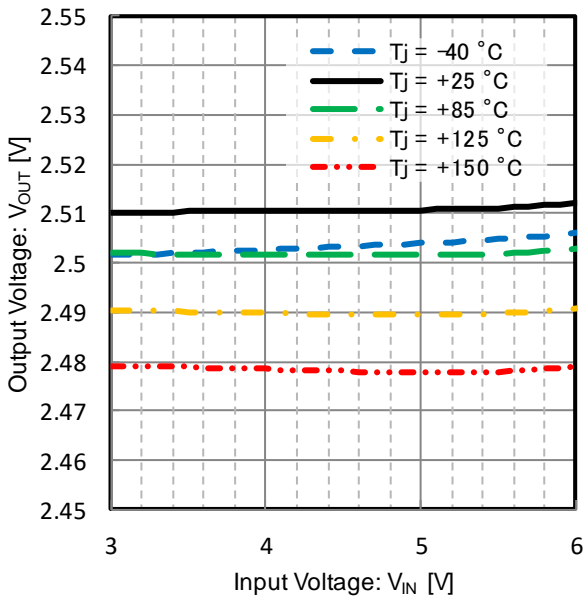

Figure 131. Line Regulation
 $V_{OUT} = 2.5\text{ V}$, $I_{OUT} = 50\text{ mA}$

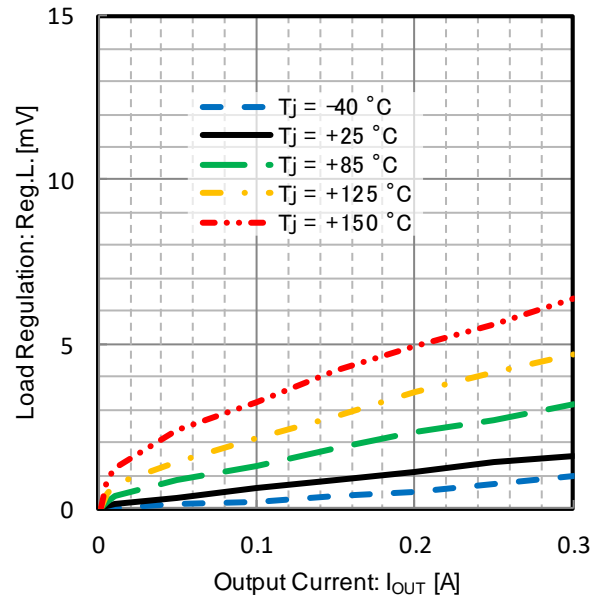

Figure 132. Load Regulation
 $V_{OUT} = 2.5\text{ V}$, $I_{OUT} = 1\text{ mA}$ to 300 mA

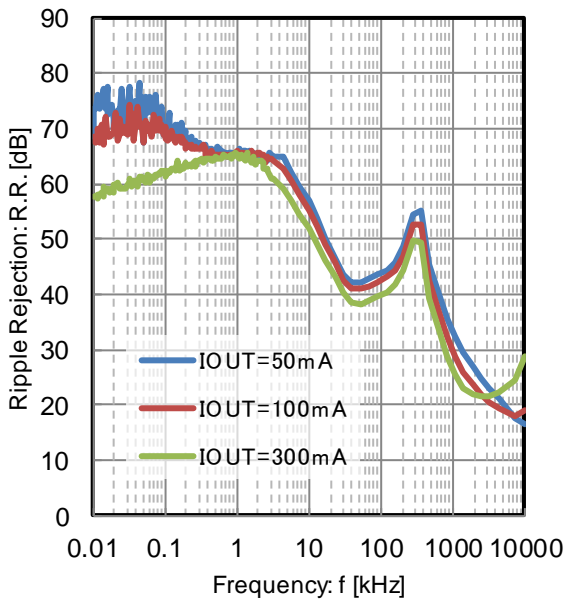

Figure 133. PSRR vs Frequency and Output Current
 $C_{IN} = 0\text{ }\mu\text{F}$, $C_{OUT} = 10\text{ }\mu\text{F}$
 $V_{OUT} = 2.5\text{ V}$

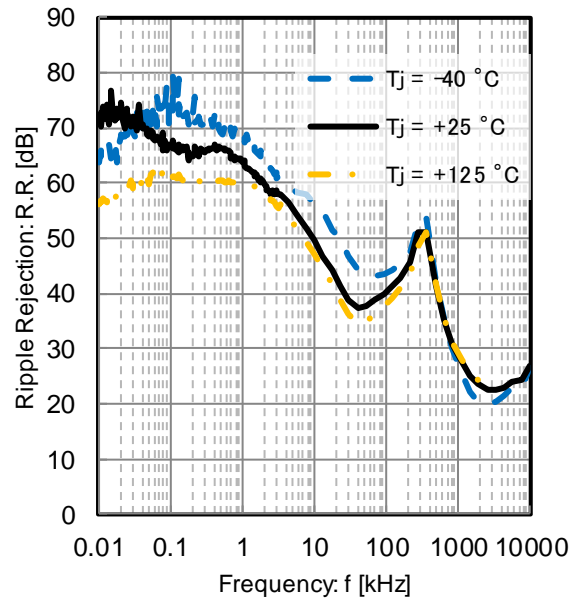

Figure 134. PSRR vs Frequency and Temperature
 $C_{IN} = 0\text{ }\mu\text{F}$, $C_{OUT} = 10\text{ }\mu\text{F}$
 $V_{IN} = 5\text{ V}$, $V_{OUT} = 2.5\text{ V}$, $I_{OUT} = 300\text{ mA}$

Typical Performance Curves (BU25JA3DG-C) - continued

Unless otherwise specified, $V_{IN} = 3.5\text{ V}$, $V_{EN} = 1.5\text{ V}$, $C_{IN} = 0.1\text{ }\mu\text{F}$, $C_{OUT} = 1.0\text{ }\mu\text{F}$

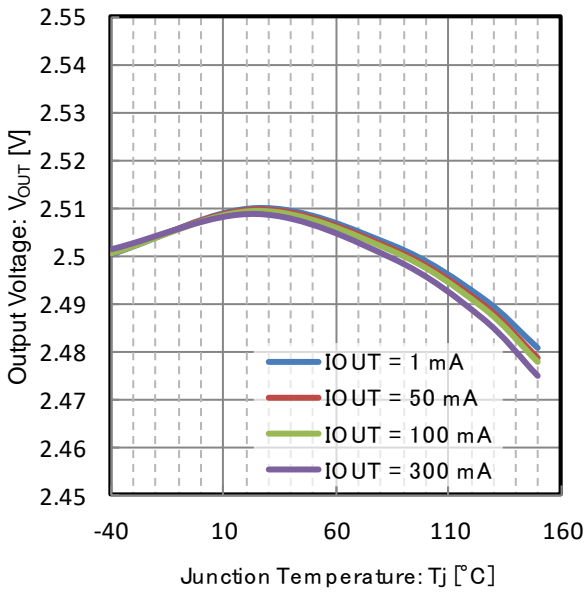

Figure 135. Output Voltage vs Junction temperature
 $V_{OUT} = 2.5\text{ V}$

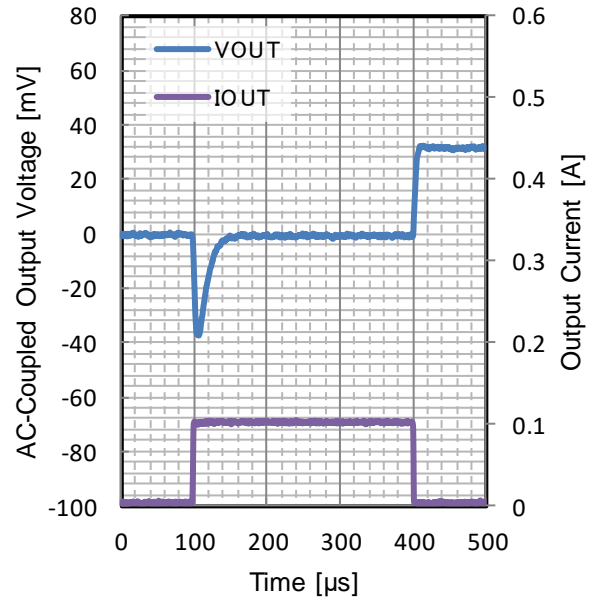

Figure 136. Load Transient
 $V_{OUT} = 2.5\text{ V}$
 $t_R = t_F = 1\text{ }\mu\text{s}$, $I_{OUT} = 0\text{ mA to }100\text{ mA}$, $C_{OUT} = 10\text{ }\mu\text{F}$
 $T_j = -40\text{ }^\circ\text{C}$

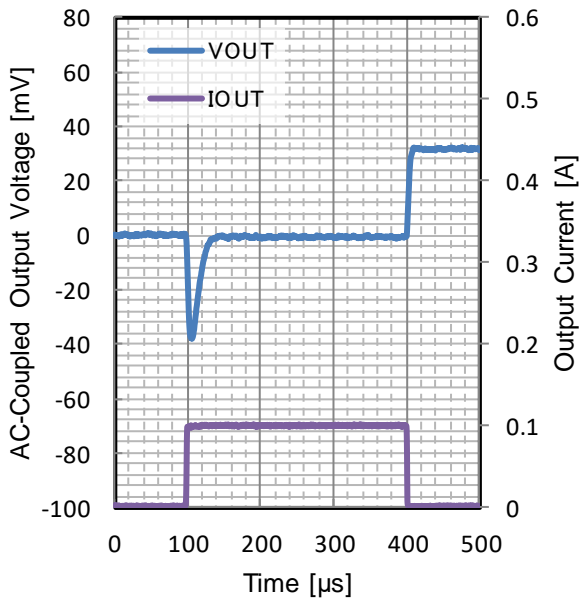

Figure 137. Load Transient
 $V_{OUT} = 2.5\text{ V}$
 $t_R = t_F = 1\text{ }\mu\text{s}$, $I_{OUT} = 0\text{ mA to }100\text{ mA}$, $C_{OUT} = 10\text{ }\mu\text{F}$
 $T_j = 25\text{ }^\circ\text{C}$

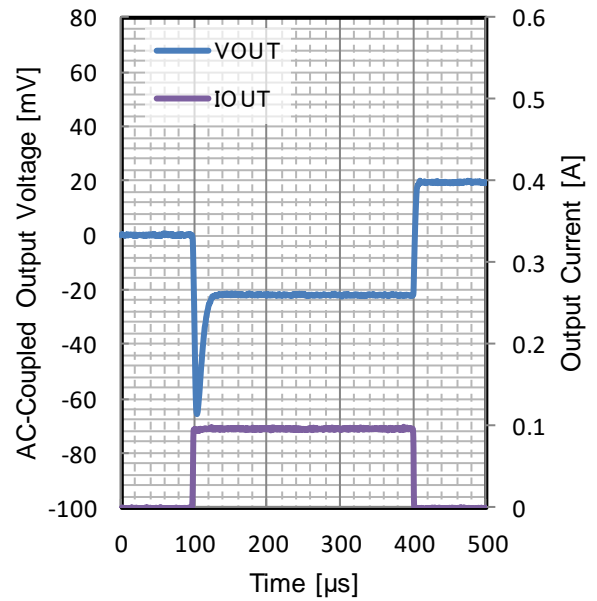

Figure 138. Load Transient
 $V_{OUT} = 2.5\text{ V}$
 $t_R = t_F = 1\text{ }\mu\text{s}$, $I_{OUT} = 0\text{ mA to }100\text{ mA}$, $C_{OUT} = 10\text{ }\mu\text{F}$
 $T_j = 150\text{ }^\circ\text{C}$

Typical Performance Curves (BU25JA3DG-C) - continued

Unless otherwise specified, $V_{IN} = 3.5\text{ V}$, $V_{EN} = 1.5\text{ V}$, $C_{IN} = 0.1\text{ }\mu\text{F}$, $C_{OUT} = 1.0\text{ }\mu\text{F}$

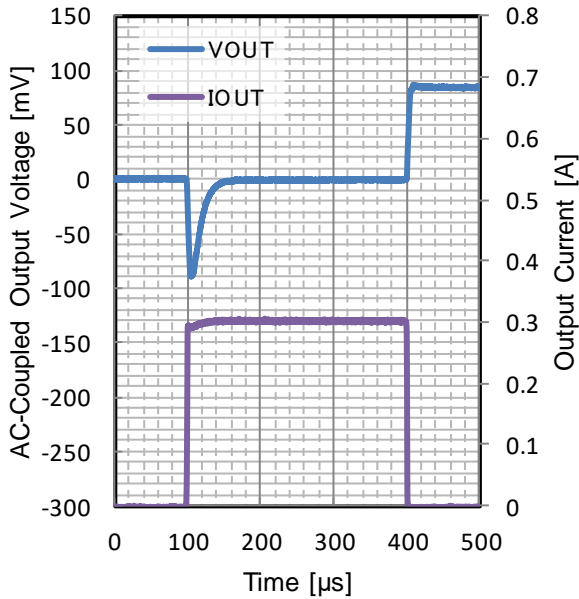

Figure 139. Load Transient

$V_{OUT} = 2.5\text{ V}$

$t_R = t_F = 1\text{ }\mu\text{s}$, $I_{OUT} = 0\text{ mA to } 300\text{ mA}$, $C_{OUT} = 10\text{ }\mu\text{F}$
 $T_j = -40\text{ }^\circ\text{C}$

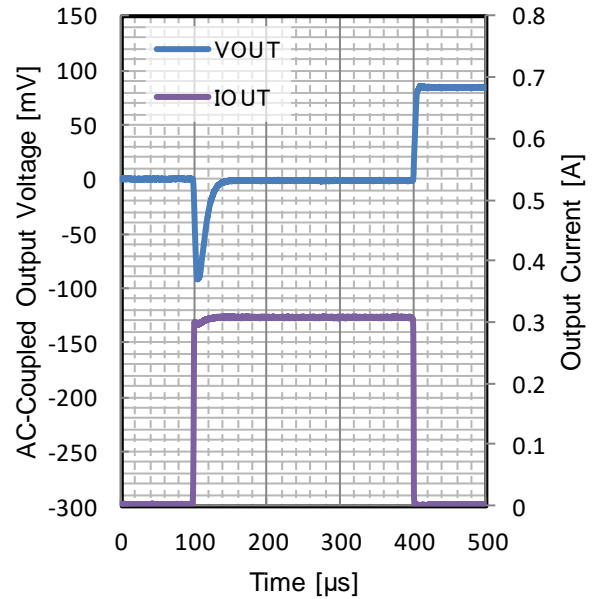

Figure 140. Load Transient

$V_{OUT} = 2.5\text{ V}$

$t_R = t_F = 1\text{ }\mu\text{s}$, $I_{OUT} = 0\text{ mA to } 300\text{ mA}$, $C_{OUT} = 10\text{ }\mu\text{F}$
 $T_j = 25\text{ }^\circ\text{C}$

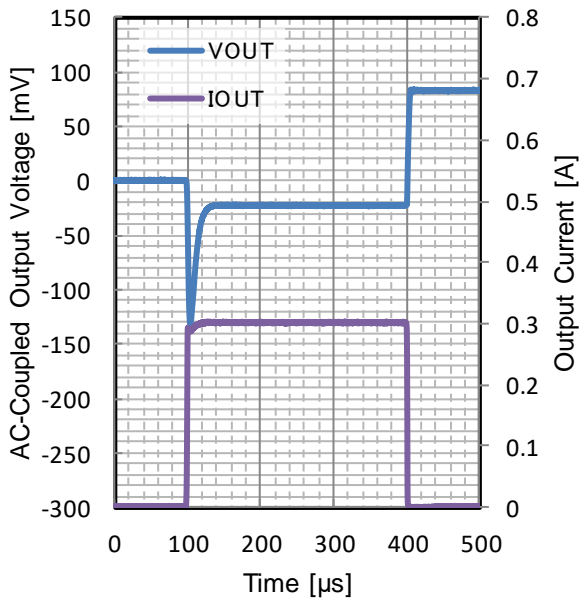

Figure 141. Load Transient

$V_{OUT} = 2.5\text{ V}$

$t_R = t_F = 1\text{ }\mu\text{s}$, $I_{OUT} = 0\text{ mA to } 300\text{ mA}$, $C_{OUT} = 10\text{ }\mu\text{F}$
 $T_j = 150\text{ }^\circ\text{C}$

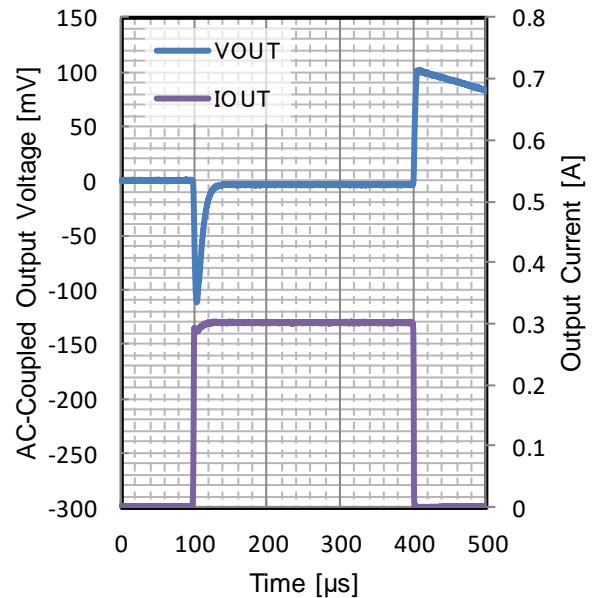

Figure 142. Load Transient

$V_{OUT} = 2.5\text{ V}$

$t_R = t_F = 1\text{ }\mu\text{s}$, $I_{OUT} = 1\text{ mA to } 300\text{ mA}$, $C_{OUT} = 10\text{ }\mu\text{F}$
 $T_j = 150\text{ }^\circ\text{C}$

Typical Performance Curves (BU25JA3DG-C) - continued

Unless otherwise specified, $V_{IN} = 3.5\text{ V}$, $V_{EN} = 1.5\text{ V}$, $C_{IN} = 0.1\text{ }\mu\text{F}$, $C_{OUT} = 1.0\text{ }\mu\text{F}$

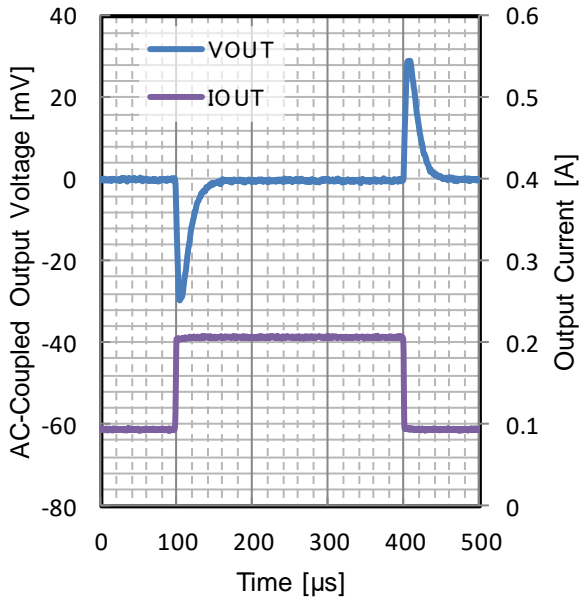

Figure 143. Load Transient

$V_{OUT} = 2.5\text{ V}$

$t_r = t_f = 1\text{ }\mu\text{s}$, $I_{OUT} = 90\text{ mA to }210\text{ mA}$, $C_{OUT} = 10\text{ }\mu\text{F}$
 $T_j = -40\text{ }^\circ\text{C}$

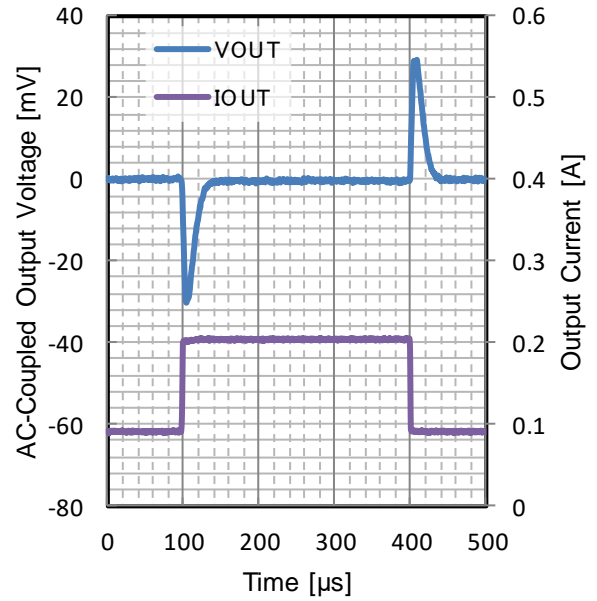

Figure 144. Load Transient

$V_{OUT} = 2.5\text{ V}$

$t_r = t_f = 1\text{ }\mu\text{s}$, $I_{OUT} = 90\text{ mA to }210\text{ mA}$, $C_{OUT} = 10\text{ }\mu\text{F}$
 $T_j = 25\text{ }^\circ\text{C}$

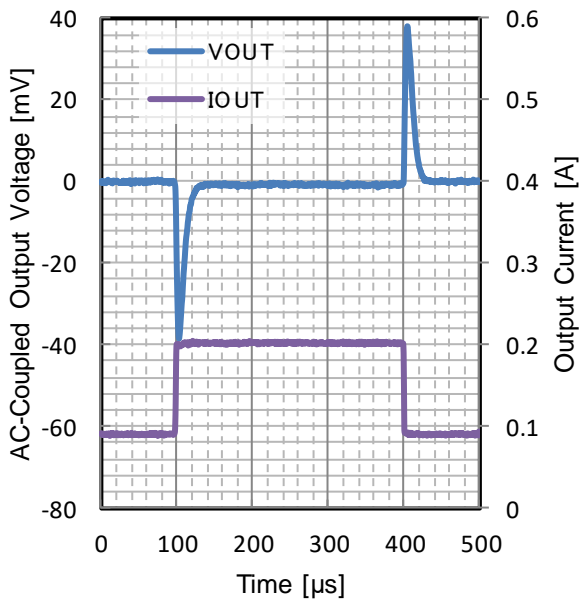

Figure 145. Load Transient

$V_{OUT} = 2.5\text{ V}$

$t_r = t_f = 1\text{ }\mu\text{s}$, $I_{OUT} = 90\text{ mA to }210\text{ mA}$, $C_{OUT} = 10\text{ }\mu\text{F}$
 $T_j = 150\text{ }^\circ\text{C}$

Typical Performance Curves (BU25JA3DG-C) - continued

Unless otherwise specified, $V_{IN} = 3.5\text{ V}$, $V_{EN} = 1.5\text{ V}$, $C_{IN} = 0.1\text{ }\mu\text{F}$, $C_{OUT} = 1.0\text{ }\mu\text{F}$

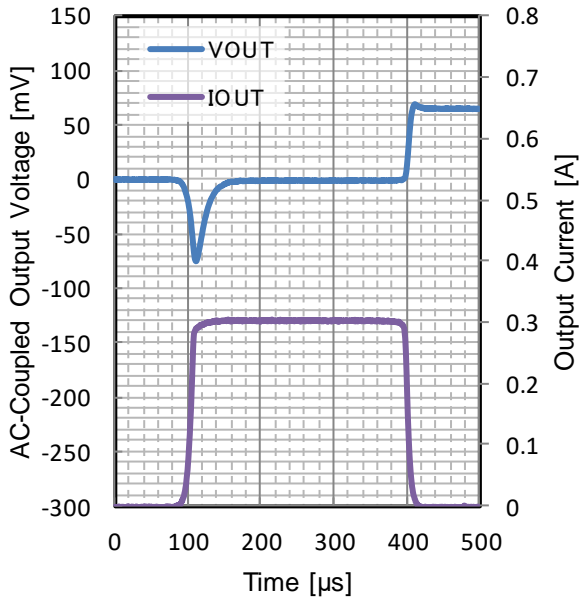

Figure 146. Load Transient

$V_{OUT} = 2.5\text{ V}$

$t_R = t_F = 10\text{ }\mu\text{s}$, $I_{OUT} = 0\text{ mA to }300\text{ mA}$, $C_{OUT} = 10\text{ }\mu\text{F}$
 $T_j = -40\text{ }^\circ\text{C}$

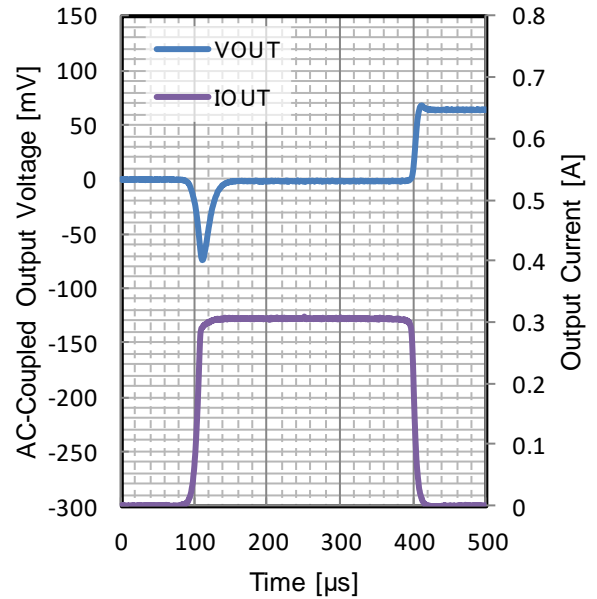

Figure 147. Load Transient

$V_{OUT} = 2.5\text{ V}$

$t_R = t_F = 10\text{ }\mu\text{s}$, $I_{OUT} = 0\text{ mA to }300\text{ mA}$, $C_{OUT} = 10\text{ }\mu\text{F}$
 $T_j = 25\text{ }^\circ\text{C}$

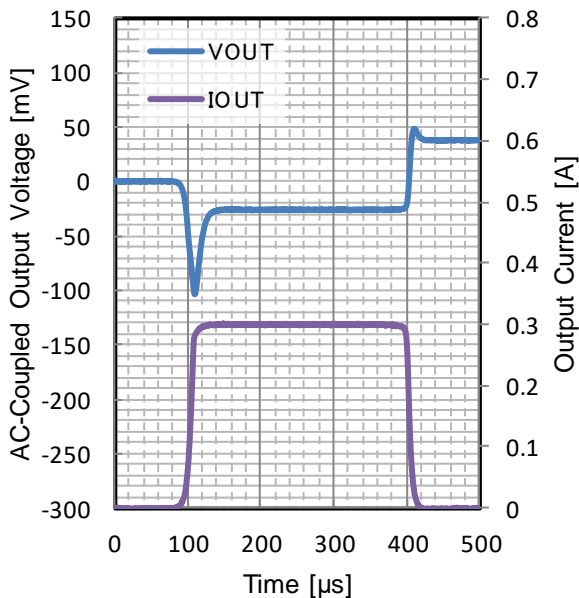

Figure 148. Load Transient

$V_{OUT} = 2.5\text{ V}$

$t_R = t_F = 10\text{ }\mu\text{s}$, $I_{OUT} = 0\text{ mA to }300\text{ mA}$, $C_{OUT} = 10\text{ }\mu\text{F}$
 $T_j = 150\text{ }^\circ\text{C}$

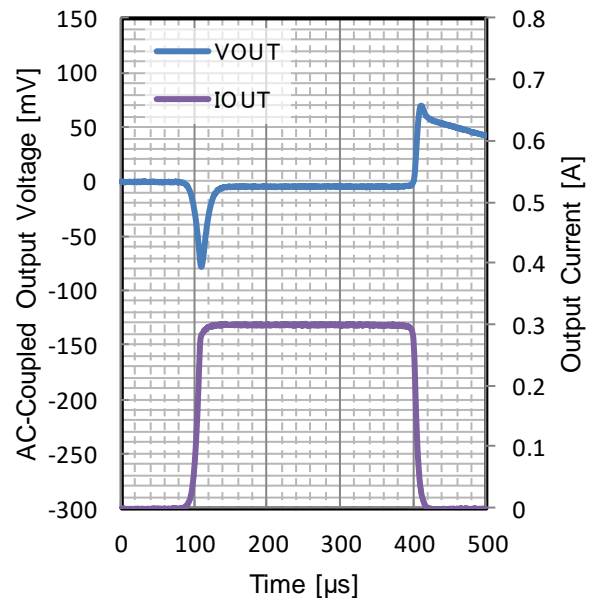

Figure 149. Load Transient

$V_{OUT} = 2.5\text{ V}$

$t_R = t_F = 10\text{ }\mu\text{s}$, $I_{OUT} = 1\text{ mA to }300\text{ mA}$, $C_{OUT} = 10\text{ }\mu\text{F}$
 $T_j = 150\text{ }^\circ\text{C}$

Typical Performance Curves (BU25JA3DG-C) - continued

Unless otherwise specified, $V_{IN} = 3.5\text{ V}$, $V_{EN} = 1.5\text{ V}$, $C_{IN} = 0.1\text{ }\mu\text{F}$, $C_{OUT} = 1.0\text{ }\mu\text{F}$

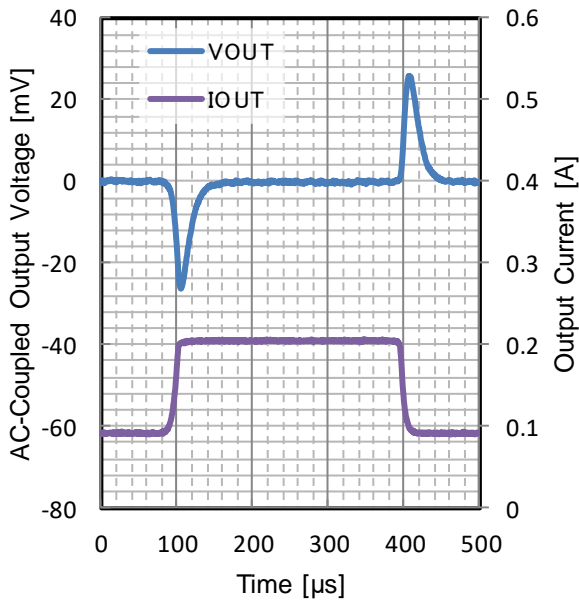

Figure 150. Load Transient

$V_{OUT} = 1.5\text{ V}$

$t_R = t_F = 10\text{ }\mu\text{s}$, $I_{OUT} = 90\text{ mA to } 210\text{ mA}$, $C_{OUT} = 10\text{ }\mu\text{F}$
 $T_j = -40\text{ }^\circ\text{C}$

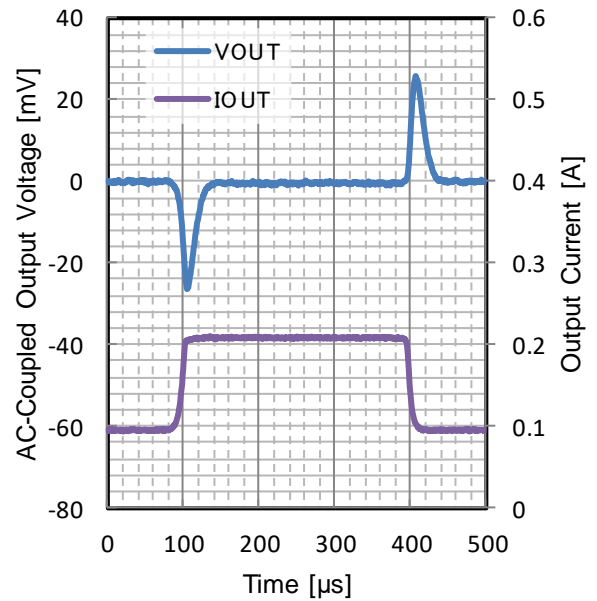

Figure 151. Load Transient

$V_{OUT} = 1.5\text{ V}$

$t_R = t_F = 10\text{ }\mu\text{s}$, $I_{OUT} = 90\text{ mA to } 210\text{ mA}$, $C_{OUT} = 10\text{ }\mu\text{F}$
 $T_j = 25\text{ }^\circ\text{C}$

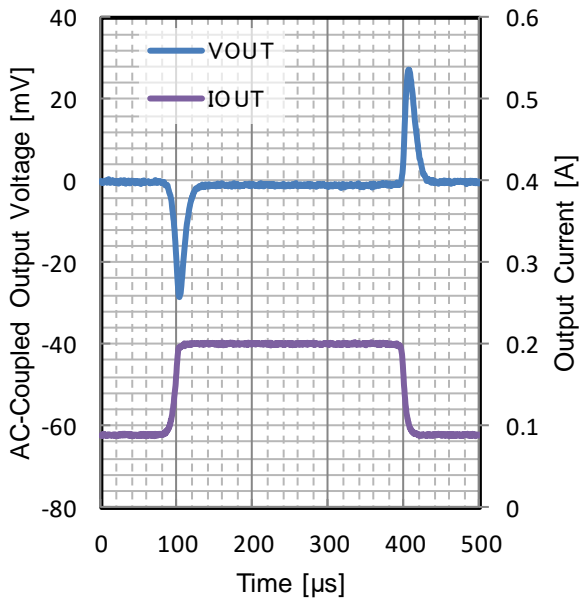

Figure 152. Load Transient

$V_{OUT} = 1.5\text{ V}$

$t_R = t_F = 10\text{ }\mu\text{s}$, $I_{OUT} = 90\text{ mA to } 210\text{ mA}$, $C_{OUT} = 10\text{ }\mu\text{F}$
 $T_j = 150\text{ }^\circ\text{C}$

Typical Performance Curves (BU25JA3DG-C) - continued

Unless otherwise specified, $V_{IN} = 3.5\text{ V}$, $V_{EN} = 1.5\text{ V}$, $C_{IN} = 0.1\text{ }\mu\text{F}$, $C_{OUT} = 1.0\text{ }\mu\text{F}$

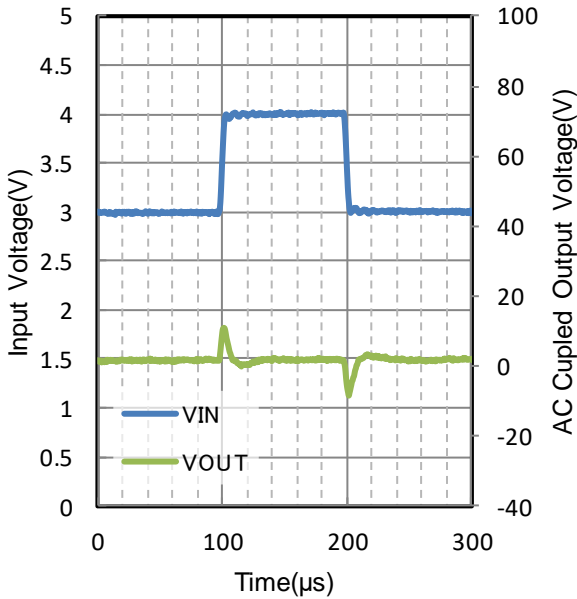

Figure 153. Line Transient
 $V_{OUT} = 2.5\text{ V}$
 $t_R = t_F = 1\text{ V}/\mu\text{s}$, $I_{OUT} = 50\text{ mA}$, $C_{OUT} = 10\text{ }\mu\text{F}$
 $T_j = -40\text{ }^\circ\text{C}$

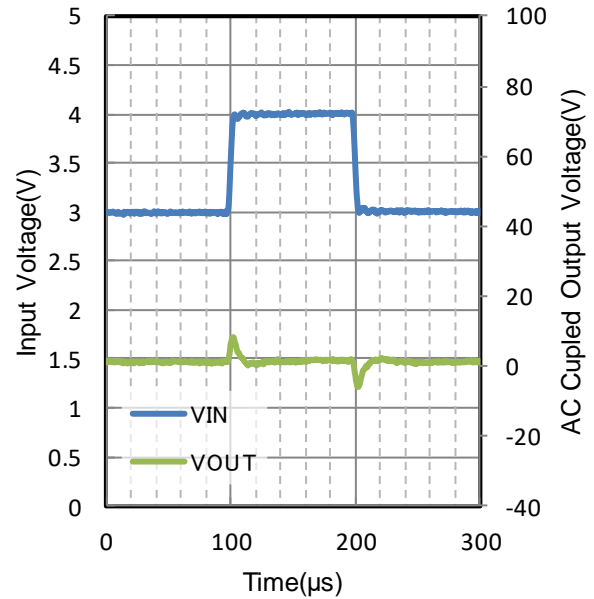

Figure 154. Line Transient
 $V_{OUT} = 2.5\text{ V}$
 $t_R = t_F = 1\text{ V}/\mu\text{s}$, $I_{OUT} = 50\text{ mA}$, $C_{OUT} = 10\text{ }\mu\text{F}$
 $T_j = 25\text{ }^\circ\text{C}$

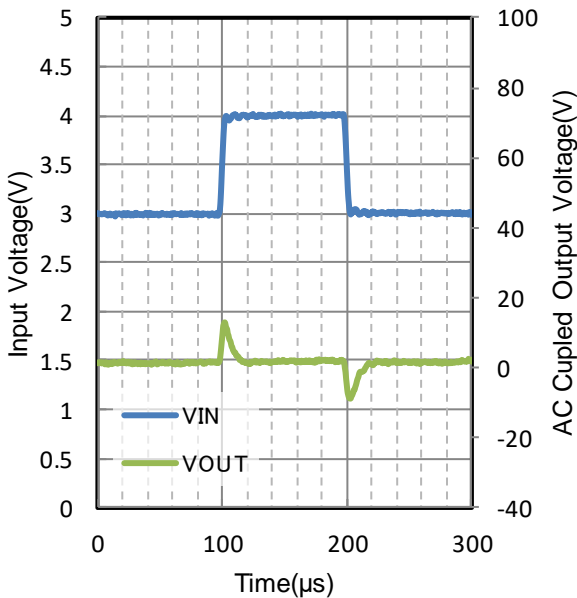

Figure 155. Line Transient
 $V_{OUT} = 2.5\text{ V}$
 $t_R = t_F = 1\text{ V}/\mu\text{s}$, $I_{OUT} = 50\text{ mA}$, $C_{OUT} = 10\text{ }\mu\text{F}$
 $T_j = 85\text{ }^\circ\text{C}$

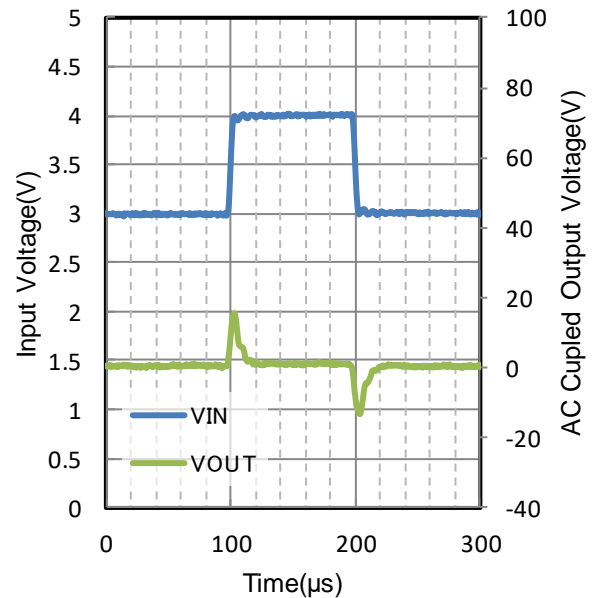

Figure 156. Line Transient
 $V_{OUT} = 2.5\text{ V}$
 $t_R = t_F = 1\text{ V}/\mu\text{s}$, $I_{OUT} = 50\text{ mA}$, $C_{OUT} = 10\text{ }\mu\text{F}$
 $T_j = 150\text{ }^\circ\text{C}$

Typical Performance Curves (BU25JA3DG-C) - continued

Unless otherwise specified, $V_{IN} = 3.5\text{ V}$, $V_{EN} = 1.5\text{ V}$, $C_{IN} = 0.1\text{ }\mu\text{F}$, $C_{OUT} = 1.0\text{ }\mu\text{F}$

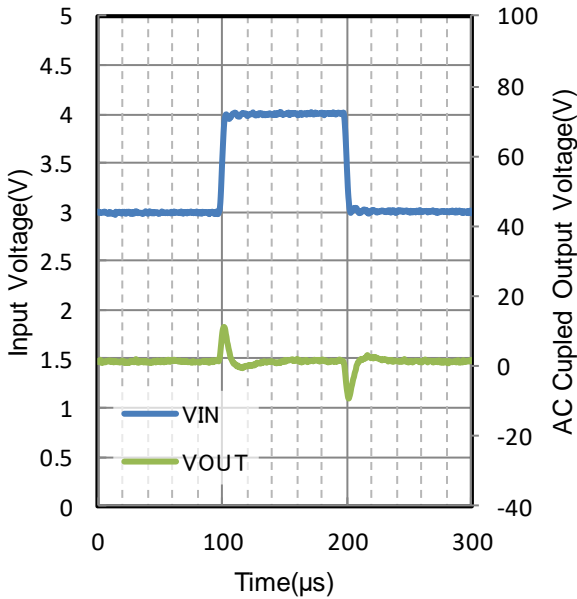

Figure 157. Line Transient
 $V_{OUT} = 2.5\text{ V}$
 $t_R = t_F = 1\text{ V}/\mu\text{s}$, $I_{OUT} = 100\text{ mA}$, $C_{OUT} = 10\text{ }\mu\text{F}$
 $T_j = -40\text{ }^\circ\text{C}$

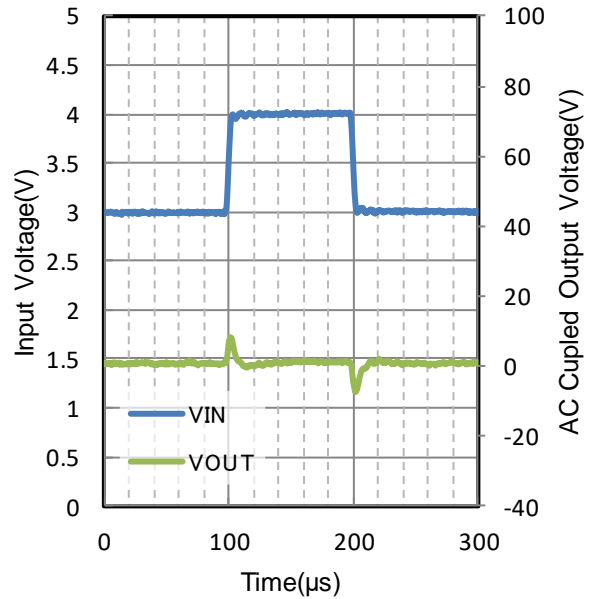

Figure 158. Line Transient
 $V_{OUT} = 2.5\text{ V}$
 $t_R = t_F = 1\text{ V}/\mu\text{s}$, $I_{OUT} = 100\text{ mA}$, $C_{OUT} = 10\text{ }\mu\text{F}$
 $T_j = 25\text{ }^\circ\text{C}$

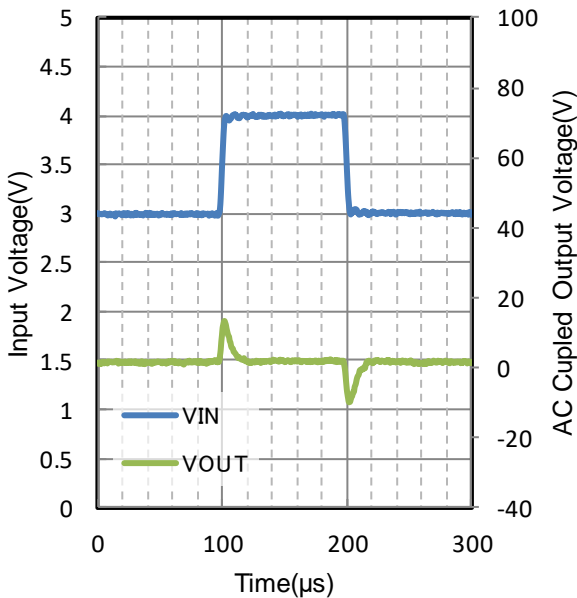

Figure 159. Line Transient
 $V_{OUT} = 2.5\text{ V}$
 $t_R = t_F = 1\text{ V}/\mu\text{s}$, $I_{OUT} = 100\text{ mA}$, $C_{OUT} = 10\text{ }\mu\text{F}$
 $T_j = 85\text{ }^\circ\text{C}$

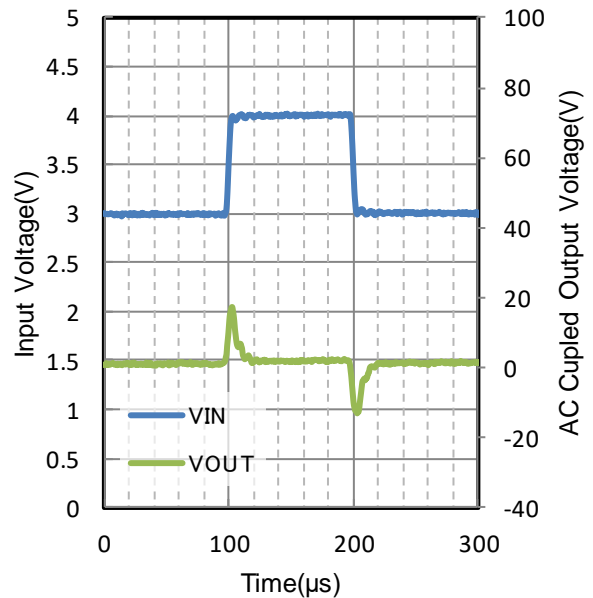

Figure 160. Line Transient
 $V_{OUT} = 2.5\text{ V}$
 $t_R = t_F = 1\text{ V}/\mu\text{s}$, $I_{OUT} = 100\text{ mA}$, $C_{OUT} = 10\text{ }\mu\text{F}$
 $T_j = 150\text{ }^\circ\text{C}$

Typical Performance Curves (BU25JA3DG-C) - continued

Unless otherwise specified, $V_{IN} = 3.5\text{ V}$, $V_{EN} = 1.5\text{ V}$, $C_{IN} = 0.1\text{ }\mu\text{F}$, $C_{OUT} = 1.0\text{ }\mu\text{F}$

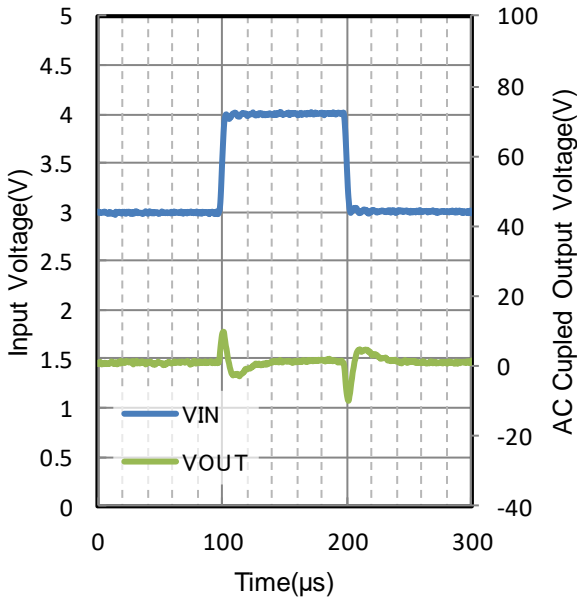

Figure 161. Line Transient
 $V_{OUT} = 2.5\text{ V}$
 $t_R = t_F = 1\text{ V}/\mu\text{s}$, $I_{OUT} = 300\text{ mA}$, $C_{OUT} = 10\text{ }\mu\text{F}$
 $T_j = -40\text{ }^\circ\text{C}$

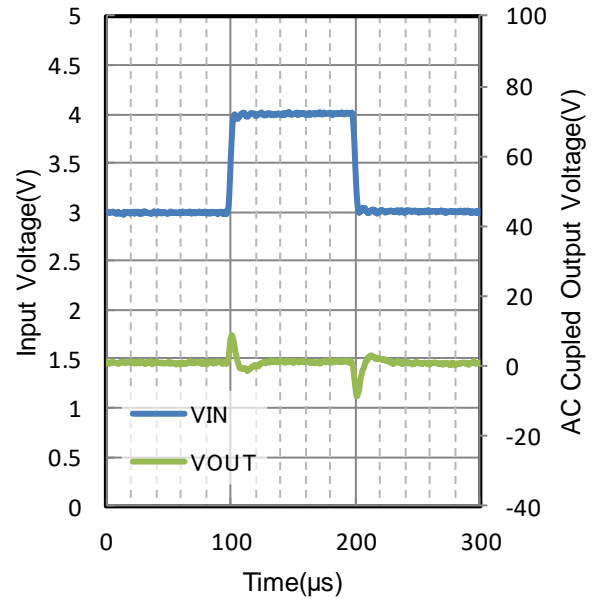

Figure 162. Line Transient
 $V_{OUT} = 2.5\text{ V}$
 $t_R = t_F = 1\text{ V}/\mu\text{s}$, $I_{OUT} = 300\text{ mA}$, $C_{OUT} = 10\text{ }\mu\text{F}$
 $T_j = 25\text{ }^\circ\text{C}$

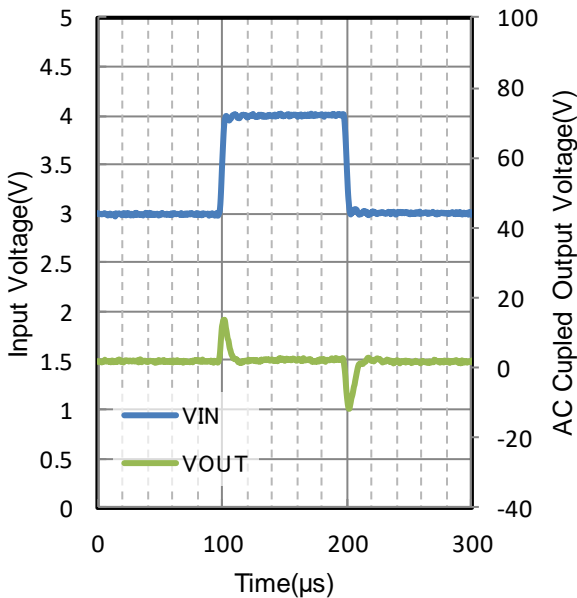

Figure 163. Line Transient
 $V_{OUT} = 2.5\text{ V}$
 $t_R = t_F = 1\text{ V}/\mu\text{s}$, $I_{OUT} = 300\text{ mA}$, $C_{OUT} = 10\text{ }\mu\text{F}$
 $T_j = 85\text{ }^\circ\text{C}$

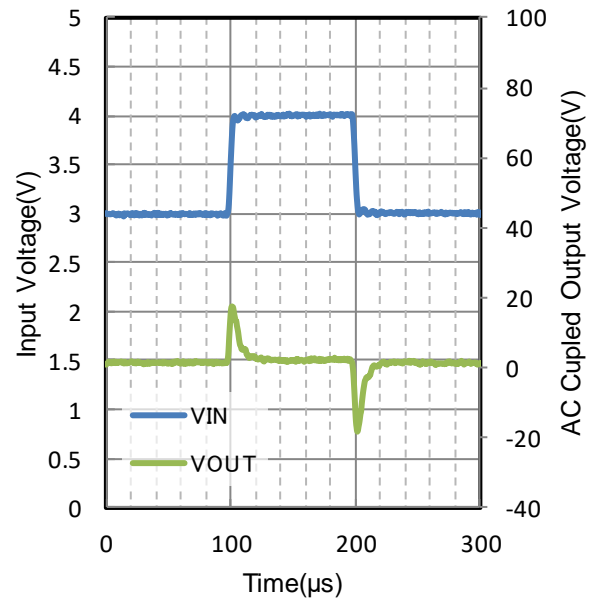

Figure 164. Line Transient
 $V_{OUT} = 2.5\text{ V}$
 $t_R = t_F = 1\text{ V}/\mu\text{s}$, $I_{OUT} = 300\text{ mA}$, $C_{OUT} = 10\text{ }\mu\text{F}$
 $T_j = 150\text{ }^\circ\text{C}$

Typical Performance Curves (BU25JA3DG-C) - continued

Unless otherwise specified, $V_{IN} = 3.5\text{ V}$, $V_{EN} = 1.5\text{ V}$, $C_{IN} = 0.1\text{ }\mu\text{F}$, $C_{OUT} = 1.0\text{ }\mu\text{F}$

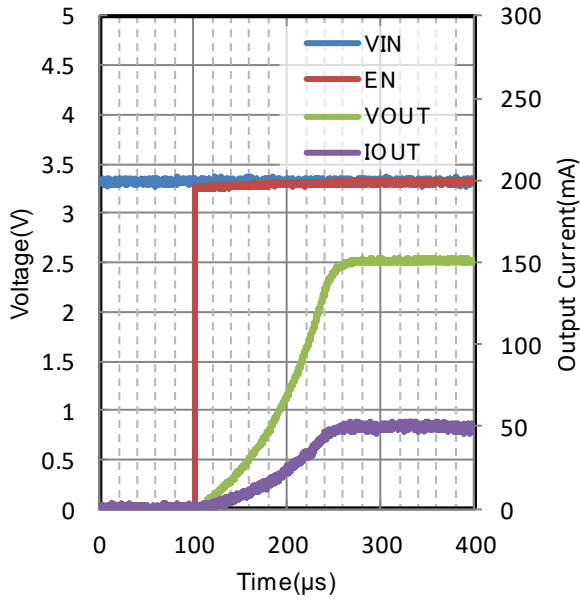

Figure 165. Start Up Waveform
 $V_{OUT} = 2.5\text{ V}$, $I_{OUT} = 50\text{ mA}$
 $V_{IN} = 3.3\text{ V}$, $C_{OUT} = 10\text{ }\mu\text{F}$
 $T_j = -40\text{ }^\circ\text{C}$

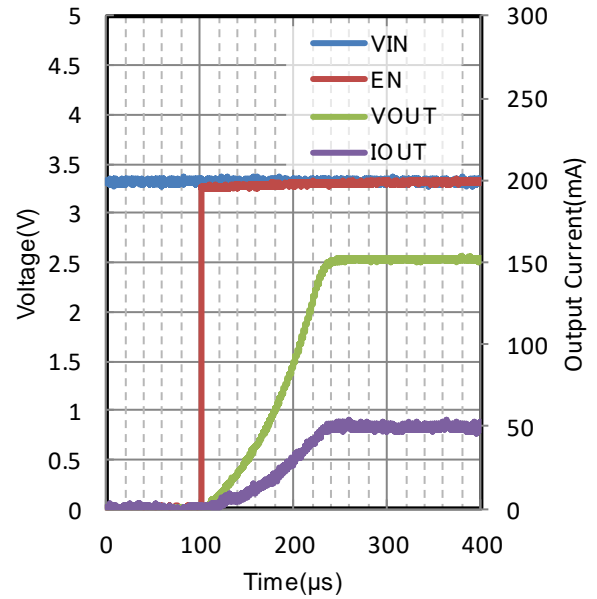

Figure 166. Start Up Waveform
 $V_{OUT} = 2.5\text{ V}$, $I_{OUT} = 50\text{ mA}$
 $V_{IN} = 3.3\text{ V}$, $C_{OUT} = 10\text{ }\mu\text{F}$
 $T_j = 25\text{ }^\circ\text{C}$

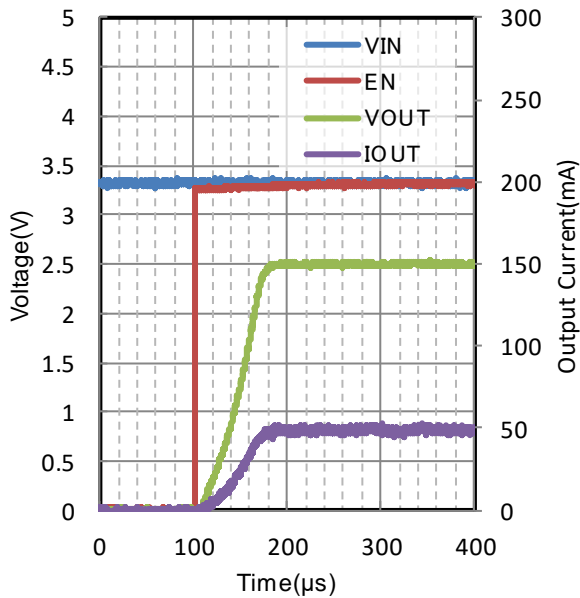

Figure 167. Start Up Waveform
 $V_{OUT} = 2.5\text{ V}$, $I_{OUT} = 50\text{ mA}$
 $V_{IN} = 3.3\text{ V}$, $C_{OUT} = 10\text{ }\mu\text{F}$
 $T_j = 150\text{ }^\circ\text{C}$

Typical Performance Curves (BU25JA3DG-C) - continued

Unless otherwise specified, $V_{IN} = 3.5\text{ V}$, $V_{EN} = 1.5\text{ V}$, $C_{IN} = 0.1\text{ }\mu\text{F}$, $C_{OUT} = 1.0\text{ }\mu\text{F}$

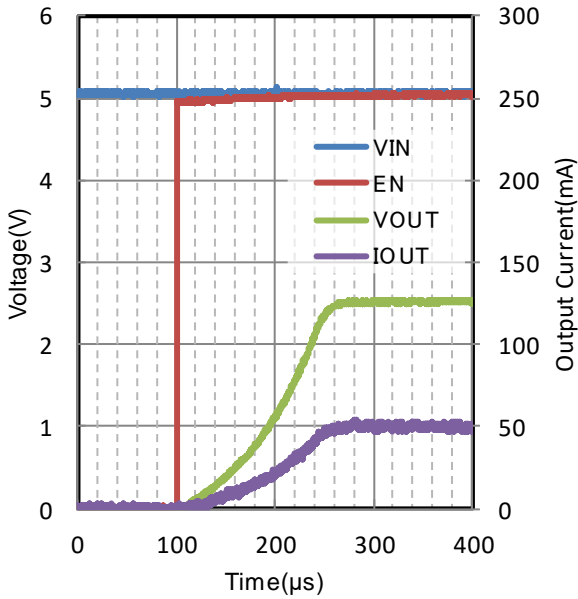

Figure 168. Start Up Waveform
 $V_{OUT} = 2.5\text{ V}$, $I_{OUT} = 50\text{ mA}$
 $V_{IN} = 5.0\text{ V}$, $C_{OUT} = 10\text{ }\mu\text{F}$
 $T_j = -40\text{ }^\circ\text{C}$

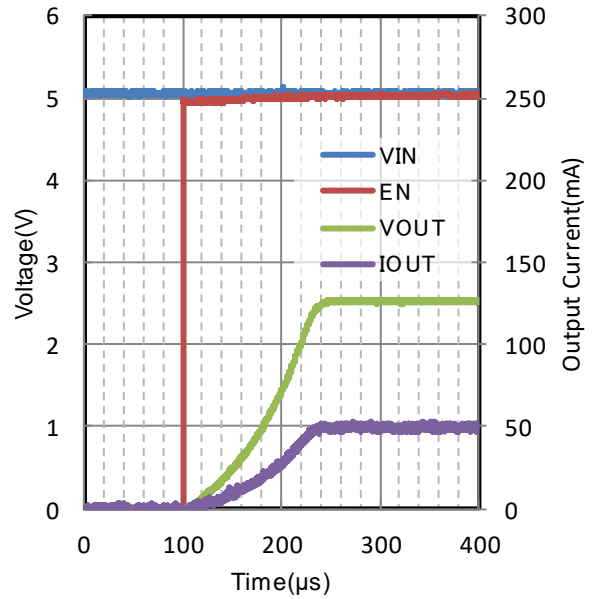

Figure 169. Start Up Waveform
 $V_{OUT} = 2.5\text{ V}$, $I_{OUT} = 50\text{ mA}$
 $V_{IN} = 5.0\text{ V}$, $C_{OUT} = 10\text{ }\mu\text{F}$
 $T_j = 25\text{ }^\circ\text{C}$

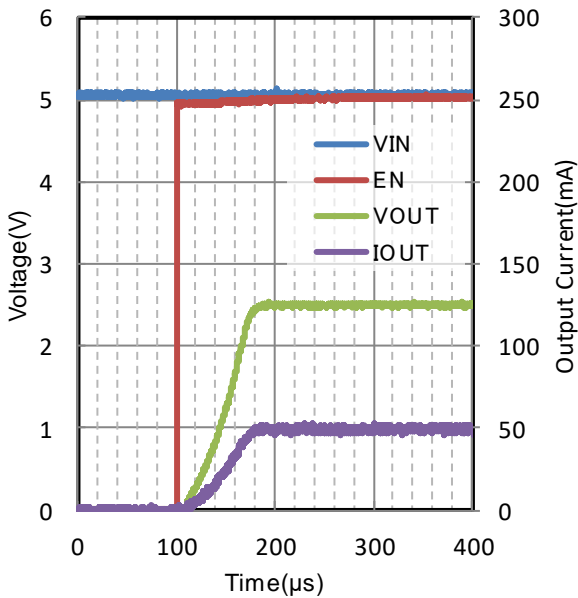

Figure 170. Start Up Waveform
 $V_{OUT} = 2.5\text{ V}$, $I_{OUT} = 50\text{ mA}$
 $V_{IN} = 5.0\text{ V}$, $C_{OUT} = 10\text{ }\mu\text{F}$
 $T_j = 150\text{ }^\circ\text{C}$

Typical Performance Curves (BU30JA3DG-C)

Unless otherwise specified, $V_{IN} = 4.0\text{ V}$, $V_{EN} = 1.5\text{ V}$, $C_{IN} = 0.1\text{ }\mu\text{F}$, $C_{OUT} = 1.0\text{ }\mu\text{F}$

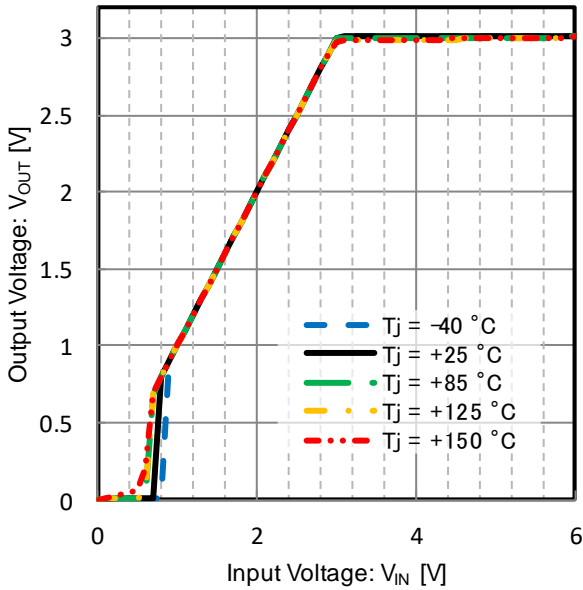

Figure 171. Output Voltage vs Input Voltage
 $V_{OUT} = 3.0\text{ V}$

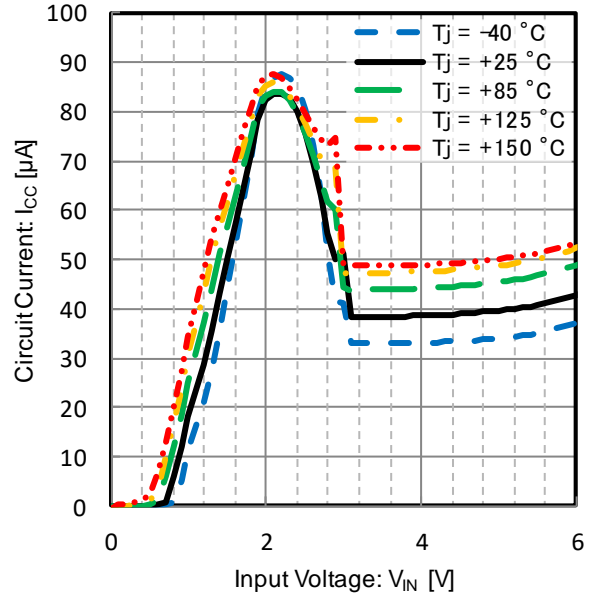

Figure 172. Circuit Current vs Input Voltage
 $V_{OUT} = 3.0\text{ V}$

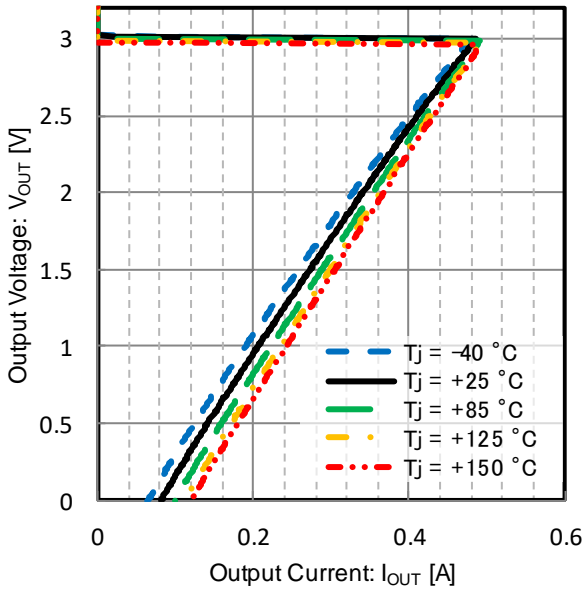

Figure 173. Output Current Limit
 $V_{OUT} = 3.0\text{ V}$

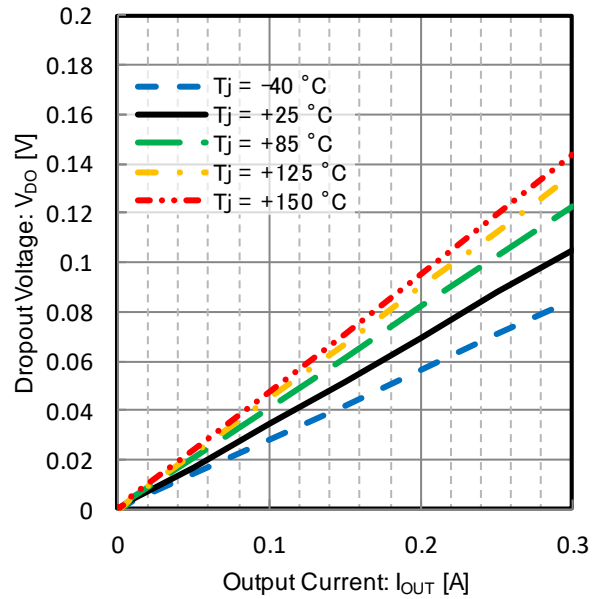

Figure 174. Dropout Voltage vs Output Current
 $V_{IN} = 2.94\text{ V}$, $V_{OUT} = 3.0\text{ V}$

Typical Performance Curves (BU30JA3DG-C) - continued

Unless otherwise specified, $V_{IN} = 4.0\text{ V}$, $V_{EN} = 1.5\text{ V}$, $C_{IN} = 0.1\text{ }\mu\text{F}$, $C_{OUT} = 1.0\text{ }\mu\text{F}$

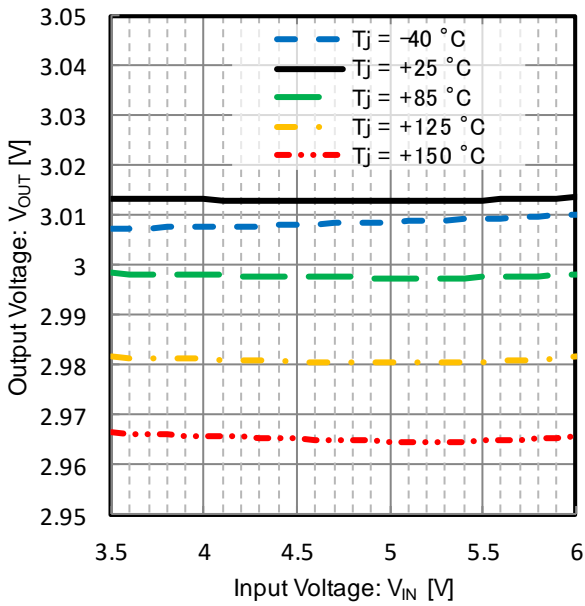

Figure 175. Line Regulation
 $V_{OUT} = 3.0\text{V}$, $I_{OUT} = 50\text{ mA}$

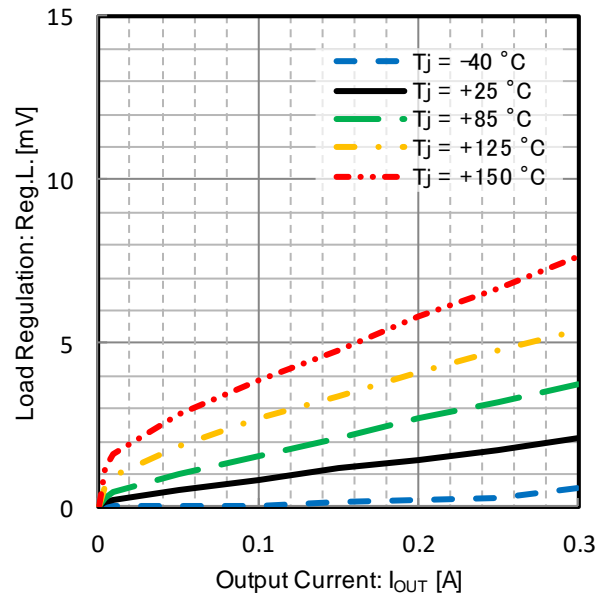

Figure 176. Load Regulation
 $V_{OUT} = 3.0\text{V}$, $I_{OUT} = 1\text{ mA}$ to 300 mA

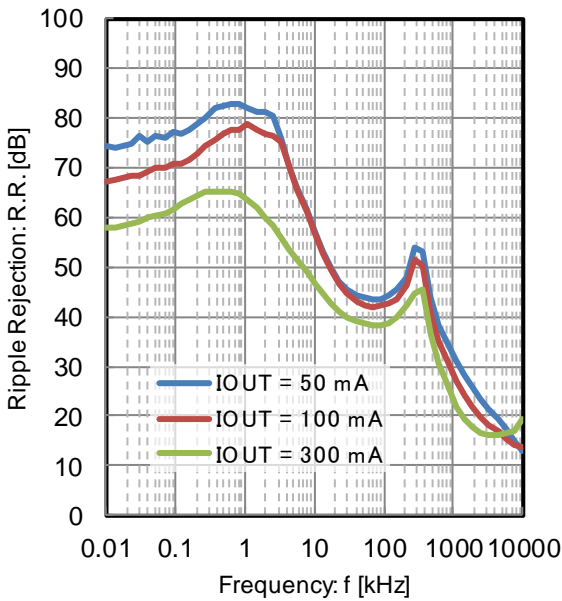

Figure 177. PSRR vs Frequency and Output Current
 $C_{IN} = 0\text{ }\mu\text{F}$, $C_{OUT} = 10\text{ }\mu\text{F}$
 $V_{OUT} = 3.0\text{ V}$

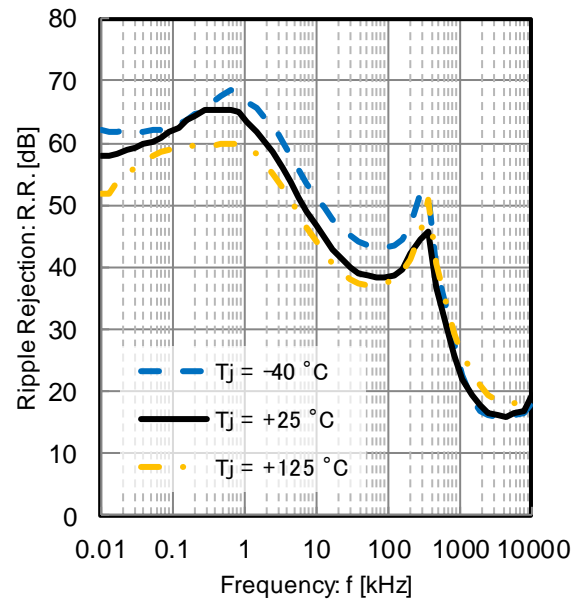

Figure 178. PSRR vs Frequency and Temperature
 $C_{IN} = 0\text{ }\mu\text{F}$, $C_{OUT} = 10\text{ }\mu\text{F}$
 $V_{IN} = 5\text{ V}$, $V_{OUT} = 3.0\text{ V}$, $I_{OUT} = 300\text{ mA}$

Typical Performance Curves (BU30JA3DG-C) - continued

Unless otherwise specified, $V_{IN} = 4.0\text{ V}$, $V_{EN} = 1.5\text{ V}$, $C_{IN} = 0.1\text{ }\mu\text{F}$, $C_{OUT} = 1.0\text{ }\mu\text{F}$

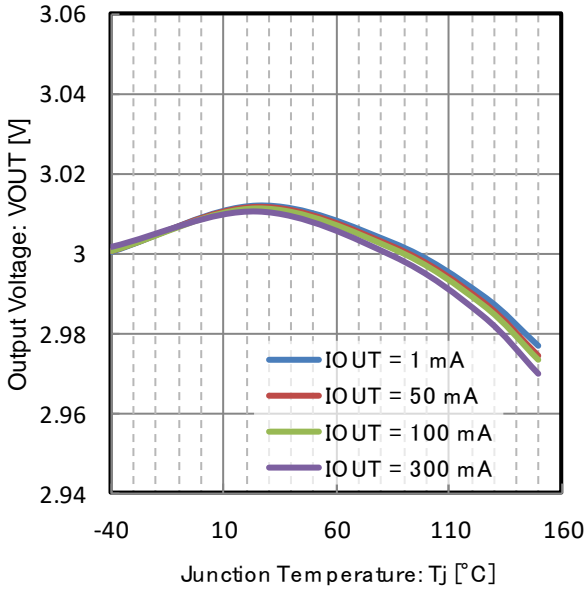

Figure 179. Output Voltage vs Junction temperature
 $V_{OUT} = 3.0\text{ V}$

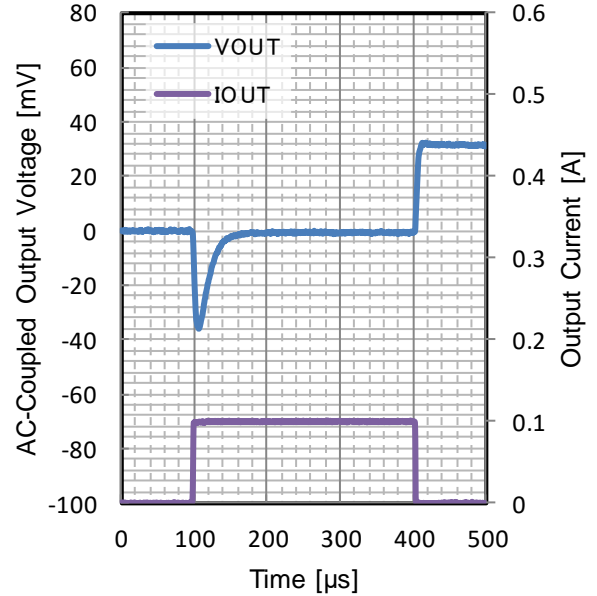

Figure 180. Load Transient
 $V_{OUT} = 3.0\text{ V}$
 $t_R = t_F = 1\text{ }\mu\text{s}$, $I_{OUT} = 0\text{ mA to }100\text{ mA}$, $C_{OUT} = 10\text{ }\mu\text{F}$
 $T_j = -40\text{ }^\circ\text{C}$

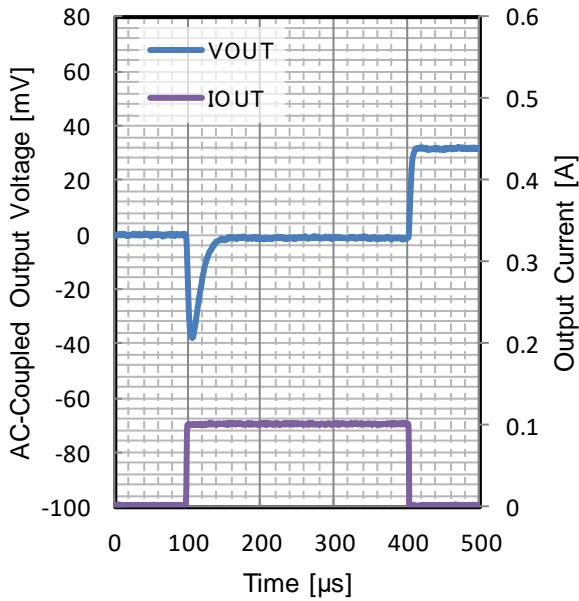

Figure 181. Load Transient
 $V_{OUT} = 3.0\text{ V}$
 $t_R = t_F = 1\text{ }\mu\text{s}$, $I_{OUT} = 0\text{ mA to }100\text{ mA}$, $C_{OUT} = 10\text{ }\mu\text{F}$
 $T_j = 25\text{ }^\circ\text{C}$

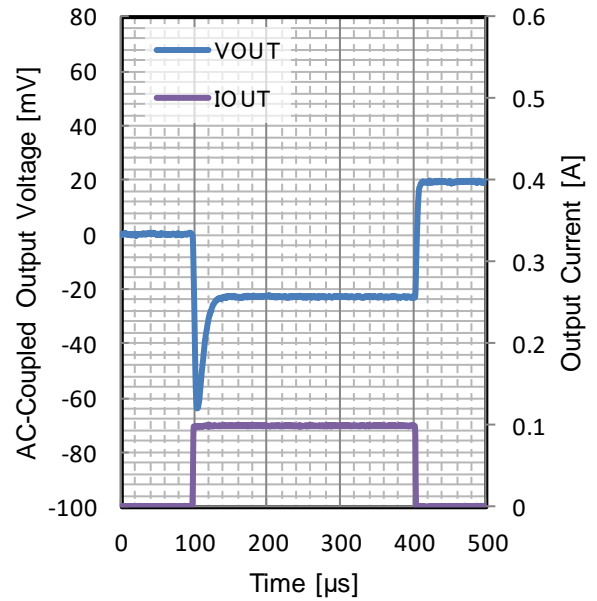

Figure 182. Load Transient
 $V_{OUT} = 3.0\text{ V}$
 $t_R = t_F = 1\text{ }\mu\text{s}$, $I_{OUT} = 0\text{ mA to }100\text{ mA}$, $C_{OUT} = 10\text{ }\mu\text{F}$
 $T_j = 150\text{ }^\circ\text{C}$

Typical Performance Curves (BU30JA3DG-C) - continued

Unless otherwise specified, $V_{IN} = 4.0\text{ V}$, $V_{EN} = 1.5\text{ V}$, $C_{IN} = 0.1\text{ }\mu\text{F}$, $C_{OUT} = 1.0\text{ }\mu\text{F}$

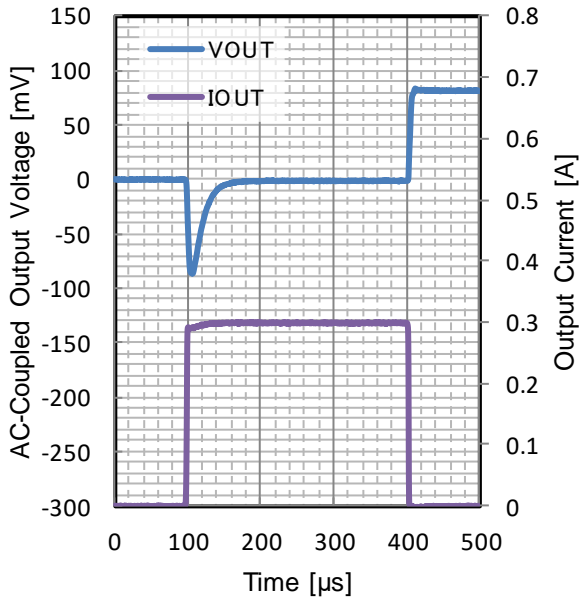

Figure 183. Load Transient
 $V_{OUT} = 3.0\text{ V}$
 $t_R = t_F = 1\text{ }\mu\text{s}$, $I_{OUT} = 0\text{ mA to }300\text{ mA}$, $C_{OUT} = 10\text{ }\mu\text{F}$
 $T_j = -40\text{ }^\circ\text{C}$

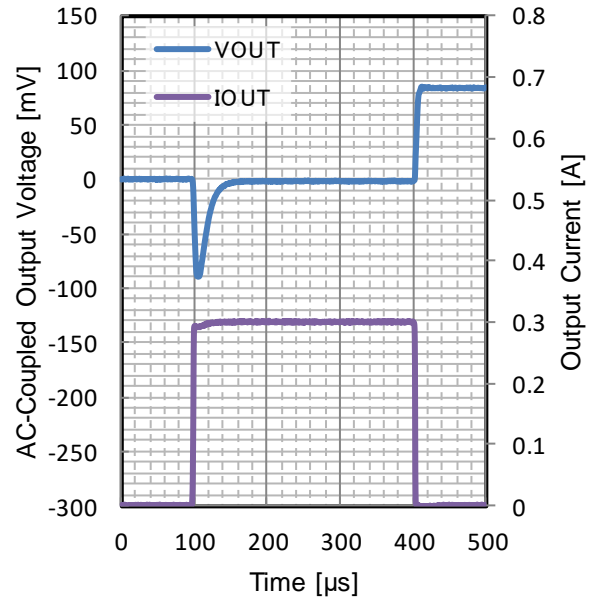

Figure 184. Load Transient
 $V_{OUT} = 3.0\text{ V}$
 $t_R = t_F = 1\text{ }\mu\text{s}$, $I_{OUT} = 0\text{ mA to }300\text{ mA}$, $C_{OUT} = 10\text{ }\mu\text{F}$
 $T_j = 25\text{ }^\circ\text{C}$

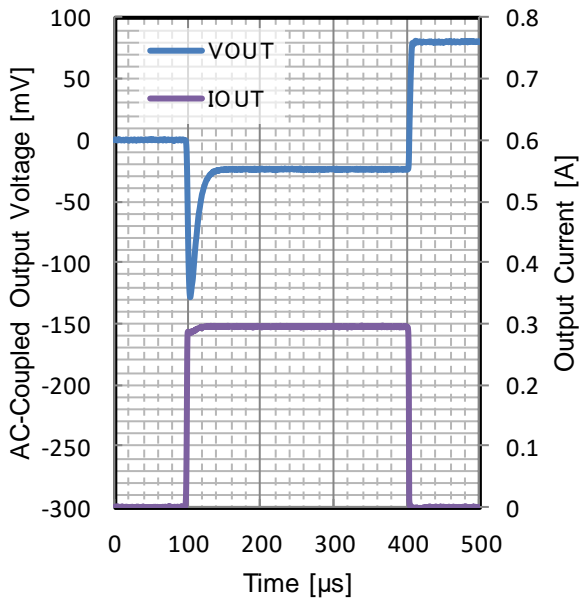

Figure 185. Load Transient
 $V_{OUT} = 3.0\text{ V}$
 $t_R = t_F = 1\text{ }\mu\text{s}$, $I_{OUT} = 0\text{ mA to }300\text{ mA}$, $C_{OUT} = 10\text{ }\mu\text{F}$
 $T_j = 150\text{ }^\circ\text{C}$

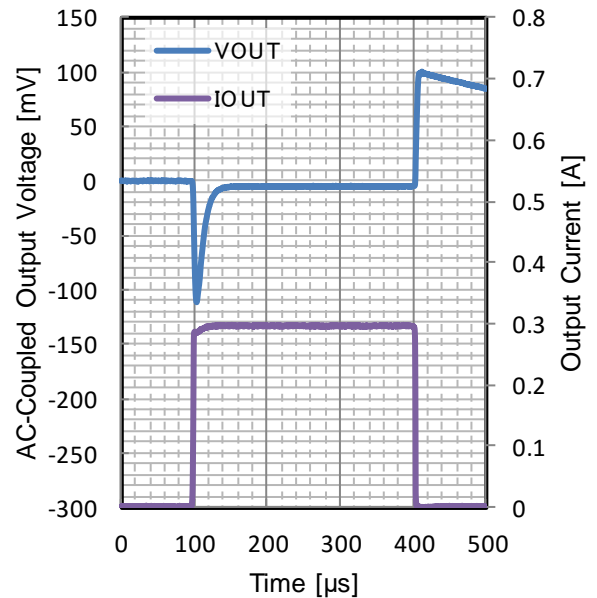

Figure 186. Load Transient
 $V_{OUT} = 3.0\text{ V}$
 $t_R = t_F = 1\text{ }\mu\text{s}$, $I_{OUT} = 1\text{ mA to }300\text{ mA}$, $C_{OUT} = 10\text{ }\mu\text{F}$
 $T_j = 150\text{ }^\circ\text{C}$

Typical Performance Curves (BU30JA3DG-C) - continued

Unless otherwise specified, $V_{IN} = 4.0\text{ V}$, $V_{EN} = 1.5\text{ V}$, $C_{IN} = 0.1\text{ }\mu\text{F}$, $C_{OUT} = 1.0\text{ }\mu\text{F}$

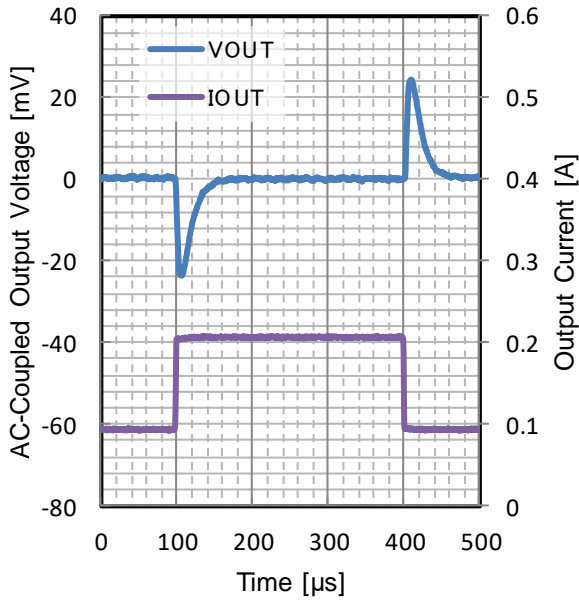

Figure 187. Load Transient

$V_{OUT} = 3.0\text{ V}$

$t_r = t_f = 1\text{ }\mu\text{s}$, $I_{OUT} = 90\text{ mA to }210\text{ mA}$, $C_{OUT} = 10\text{ }\mu\text{F}$
 $T_j = -40\text{ }^\circ\text{C}$

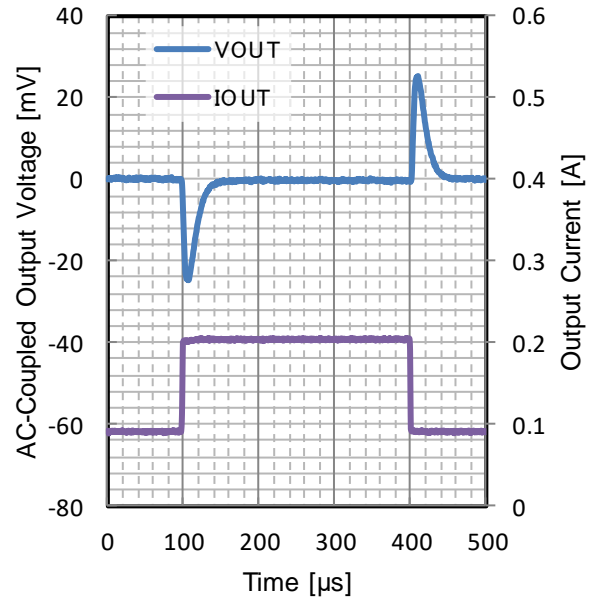

Figure 188. Load Transient

$V_{OUT} = 3.0\text{ V}$

$t_r = t_f = 1\text{ }\mu\text{s}$, $I_{OUT} = 90\text{ mA to }210\text{ mA}$, $C_{OUT} = 10\text{ }\mu\text{F}$
 $T_j = 25\text{ }^\circ\text{C}$

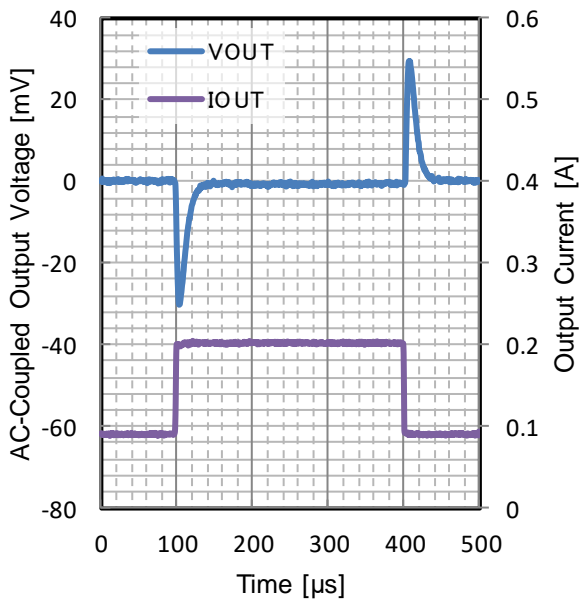

Figure 189. Load Transient

$V_{OUT} = 3.0\text{ V}$

$t_r = t_f = 1\text{ }\mu\text{s}$, $I_{OUT} = 90\text{ mA to }210\text{ mA}$, $C_{OUT} = 10\text{ }\mu\text{F}$
 $T_j = 150\text{ }^\circ\text{C}$

Typical Performance Curves (BU30JA3DG-C) - continued

Unless otherwise specified, $V_{IN} = 4.0\text{ V}$, $V_{EN} = 1.5\text{ V}$, $C_{IN} = 0.1\text{ }\mu\text{F}$, $C_{OUT} = 1.0\text{ }\mu\text{F}$

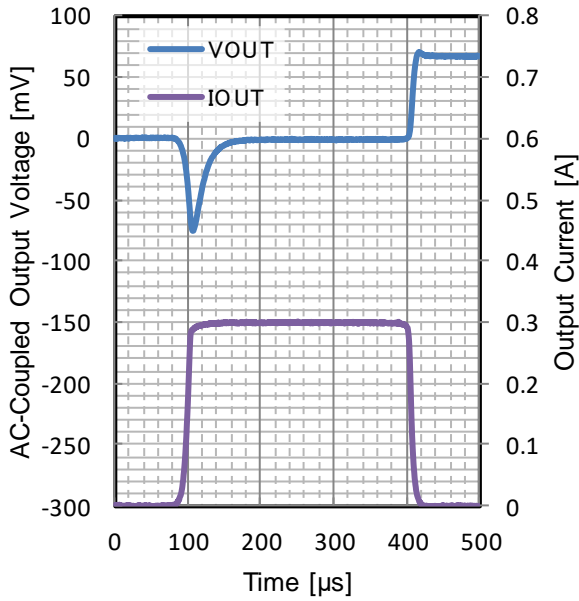

Figure 190. Load Transient

$V_{OUT} = 3.0\text{ V}$

$t_R = t_F = 10\text{ }\mu\text{s}$, $I_{OUT} = 0\text{ mA to }300\text{ mA}$, $C_{OUT} = 10\text{ }\mu\text{F}$
 $T_j = -40\text{ }^\circ\text{C}$

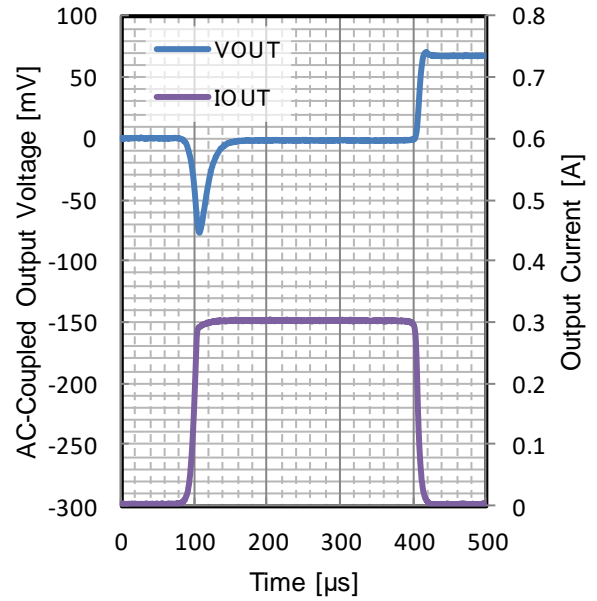

Figure 191. Load Transient

$V_{OUT} = 3.0\text{ V}$

$t_R = t_F = 10\text{ }\mu\text{s}$, $I_{OUT} = 0\text{ mA to }300\text{ mA}$, $C_{OUT} = 10\text{ }\mu\text{F}$
 $T_j = 25\text{ }^\circ\text{C}$

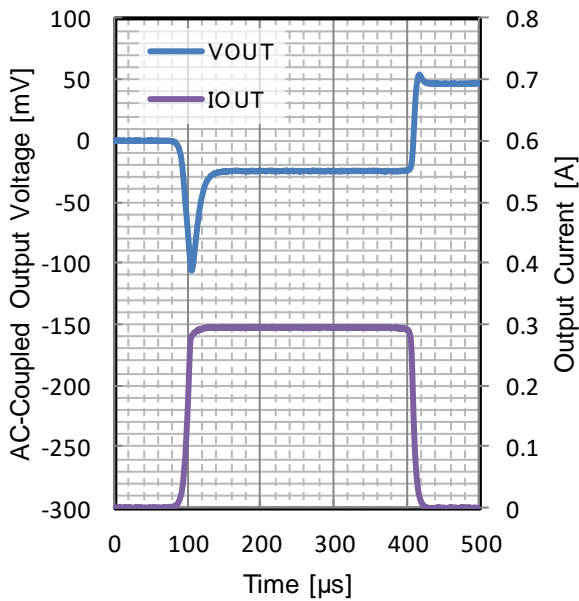

Figure 192. Load Transient

$V_{OUT} = 3.0\text{ V}$

$t_R = t_F = 10\text{ }\mu\text{s}$, $I_{OUT} = 0\text{ mA to }300\text{ mA}$, $C_{OUT} = 10\text{ }\mu\text{F}$
 $T_j = 150\text{ }^\circ\text{C}$

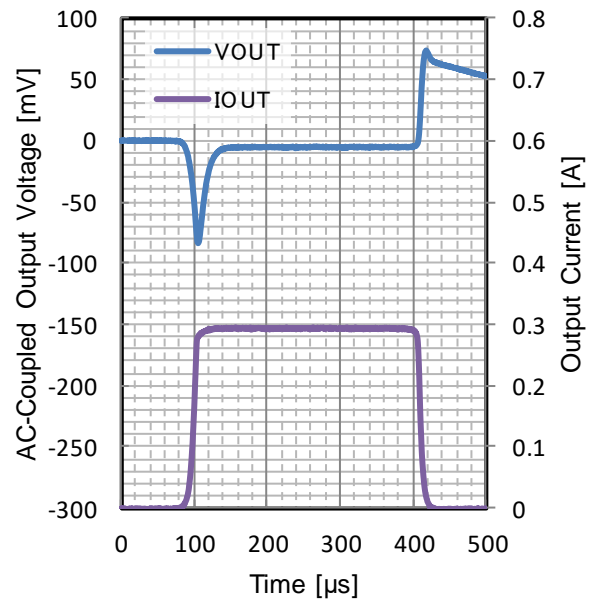

Figure 193. Load Transient

$V_{OUT} = 3.0\text{ V}$

$t_R = t_F = 10\text{ }\mu\text{s}$, $I_{OUT} = 1\text{ mA to }300\text{ mA}$, $C_{OUT} = 10\text{ }\mu\text{F}$
 $T_j = 150\text{ }^\circ\text{C}$

Typical Performance Curves (BU30JA3DG-C) - continued

Unless otherwise specified, $V_{IN} = 4.0\text{ V}$, $V_{EN} = 1.5\text{ V}$, $C_{IN} = 0.1\text{ }\mu\text{F}$, $C_{OUT} = 1.0\text{ }\mu\text{F}$

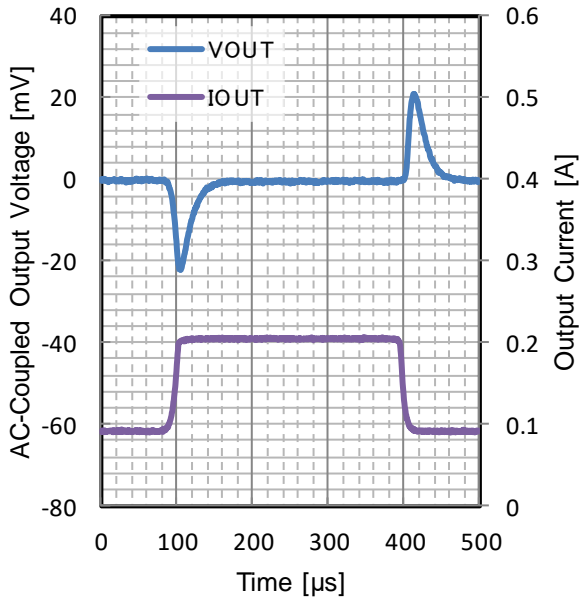

Figure 194. Load Transient

$V_{OUT} = 3.0\text{ V}$

$t_R = t_F = 10\text{ }\mu\text{s}$, $I_{OUT} = 90\text{ mA to }210\text{ mA}$, $C_{OUT} = 10\text{ }\mu\text{F}$
 $T_j = -40\text{ }^\circ\text{C}$

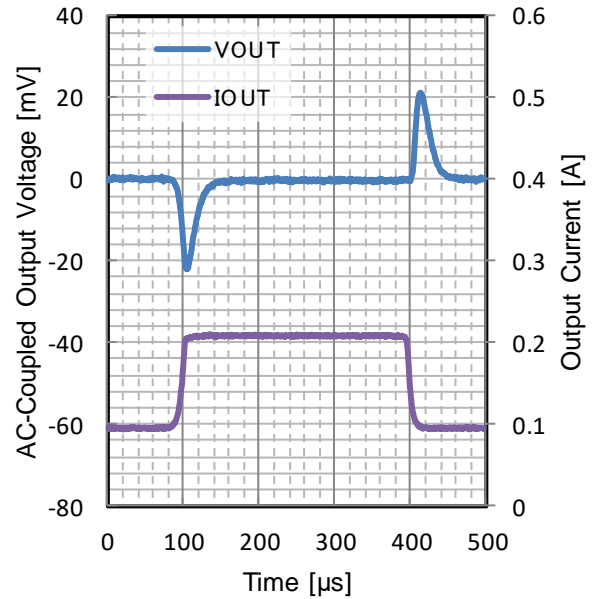

Figure 195. Load Transient

$V_{OUT} = 3.0\text{ V}$

$t_R = t_F = 10\text{ }\mu\text{s}$, $I_{OUT} = 90\text{ mA to }210\text{ mA}$, $C_{OUT} = 10\text{ }\mu\text{F}$
 $T_j = 25\text{ }^\circ\text{C}$

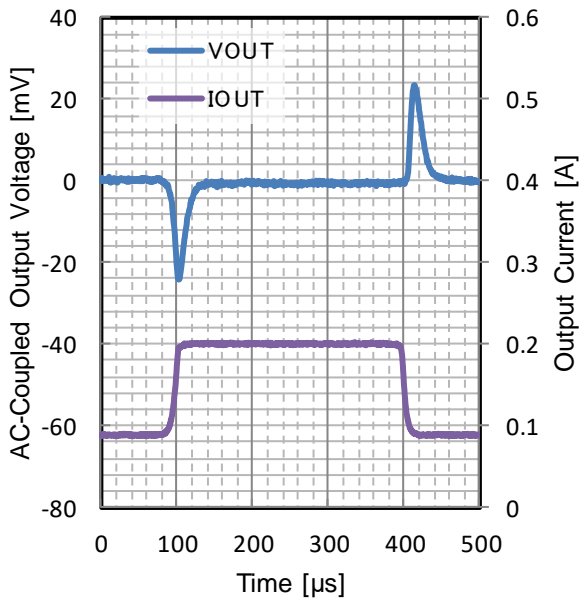

Figure 196. Load Transient

$V_{OUT} = 3.0\text{ V}$

$t_R = t_F = 10\text{ }\mu\text{s}$, $I_{OUT} = 90\text{ mA to }210\text{ mA}$, $C_{OUT} = 10\text{ }\mu\text{F}$
 $T_j = 150\text{ }^\circ\text{C}$

Typical Performance Curves (BU30JA3DG-C) - continued

Unless otherwise specified, $V_{IN} = 4.0\text{ V}$, $V_{EN} = 1.5\text{ V}$, $C_{IN} = 0.1\text{ }\mu\text{F}$, $C_{OUT} = 1.0\text{ }\mu\text{F}$

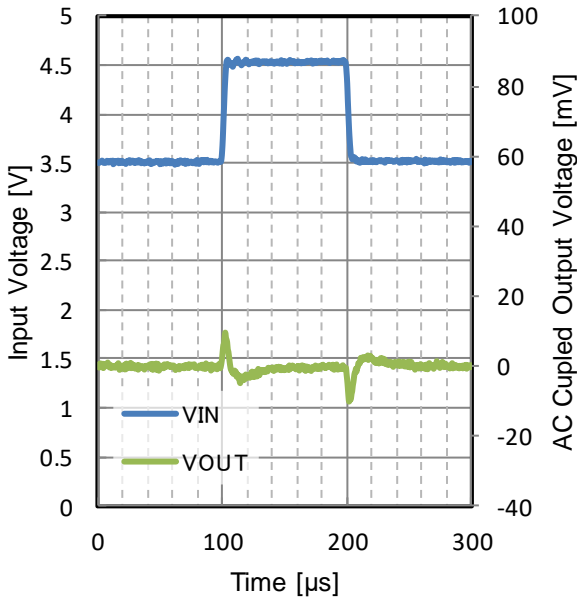

Figure 197. Line Transient
 $V_{OUT} = 3.0\text{ V}$
 $t_R = t_F = 1\text{ V}/\mu\text{s}$, $I_{OUT} = 50\text{ mA}$, $C_{OUT} = 10\text{ }\mu\text{F}$
 $T_j = -40\text{ }^\circ\text{C}$

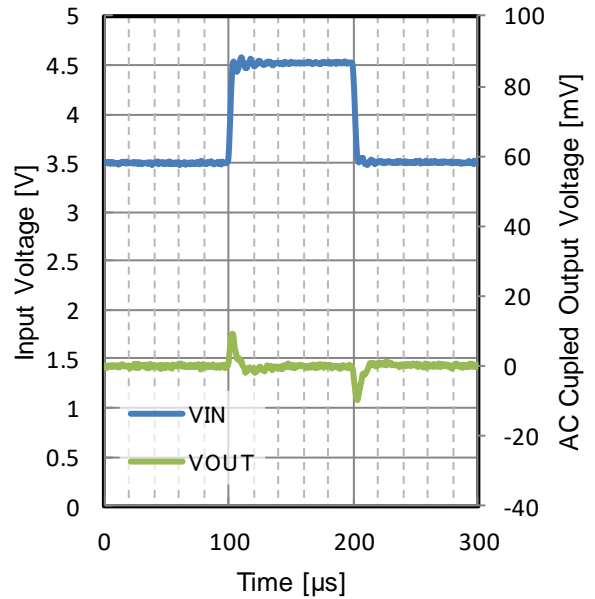

Figure 198. Line Transient
 $V_{OUT} = 3.0\text{ V}$
 $t_R = t_F = 1\text{ V}/\mu\text{s}$, $I_{OUT} = 50\text{ mA}$, $C_{OUT} = 10\text{ }\mu\text{F}$
 $T_j = 25\text{ }^\circ\text{C}$

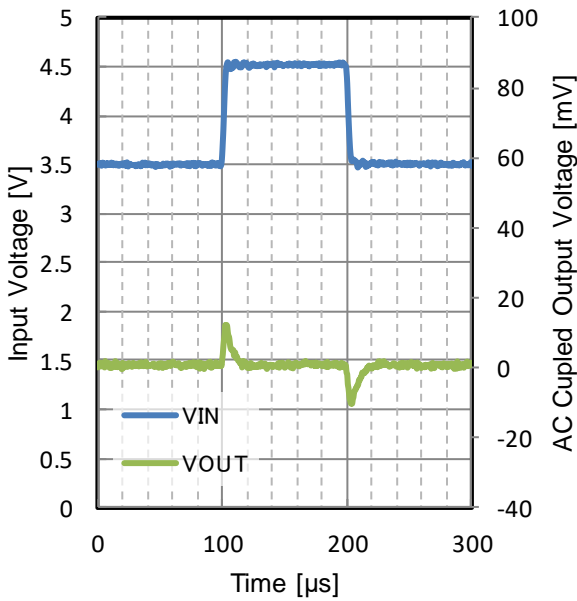

Figure 199. Line Transient
 $V_{OUT} = 3.0\text{ V}$
 $t_R = t_F = 1\text{ V}/\mu\text{s}$, $I_{OUT} = 50\text{ mA}$, $C_{OUT} = 10\text{ }\mu\text{F}$
 $T_j = 85\text{ }^\circ\text{C}$

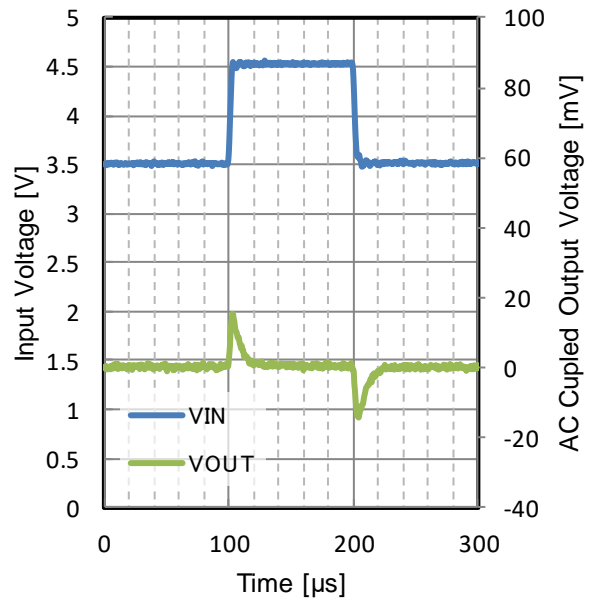

Figure 200. Line Transient
 $V_{OUT} = 3.0\text{ V}$
 $t_R = t_F = 1\text{ V}/\mu\text{s}$, $I_{OUT} = 50\text{ mA}$, $C_{OUT} = 10\text{ }\mu\text{F}$
 $T_j = 150\text{ }^\circ\text{C}$

Typical Performance Curves (BU30JA3DG-C) - continued

Unless otherwise specified, $V_{IN} = 4.0\text{ V}$, $V_{EN} = 1.5\text{ V}$, $C_{IN} = 0.1\text{ }\mu\text{F}$, $C_{OUT} = 1.0\text{ }\mu\text{F}$

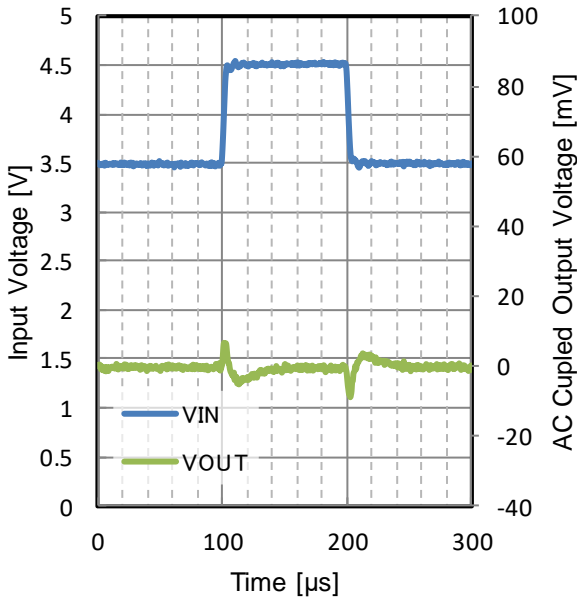

Figure 201. Line Transient
 $V_{OUT} = 3.0\text{ V}$
 $t_R = t_F = 1\text{ V}/\mu\text{s}$, $I_{OUT} = 100\text{ mA}$, $C_{OUT} = 10\text{ }\mu\text{F}$
 $T_j = -40\text{ }^\circ\text{C}$

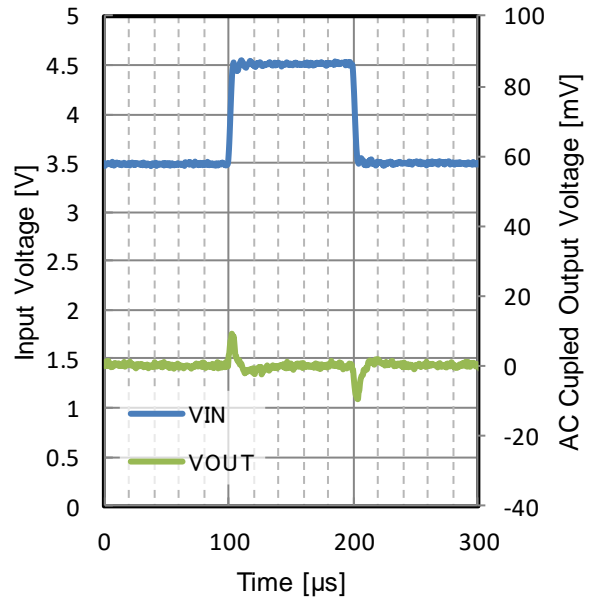

Figure 202. Line Transient
 $V_{OUT} = 3.0\text{ V}$
 $t_R = t_F = 1\text{ V}/\mu\text{s}$, $I_{OUT} = 100\text{ mA}$, $C_{OUT} = 10\text{ }\mu\text{F}$
 $T_j = 25\text{ }^\circ\text{C}$

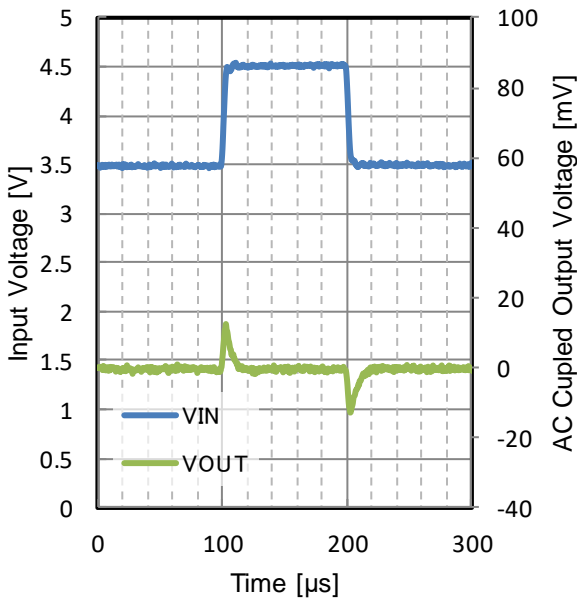

Figure 203. Line Transient
 $V_{OUT} = 3.0\text{ V}$
 $t_R = t_F = 1\text{ V}/\mu\text{s}$, $I_{OUT} = 100\text{ mA}$, $C_{OUT} = 10\text{ }\mu\text{F}$
 $T_j = 85\text{ }^\circ\text{C}$

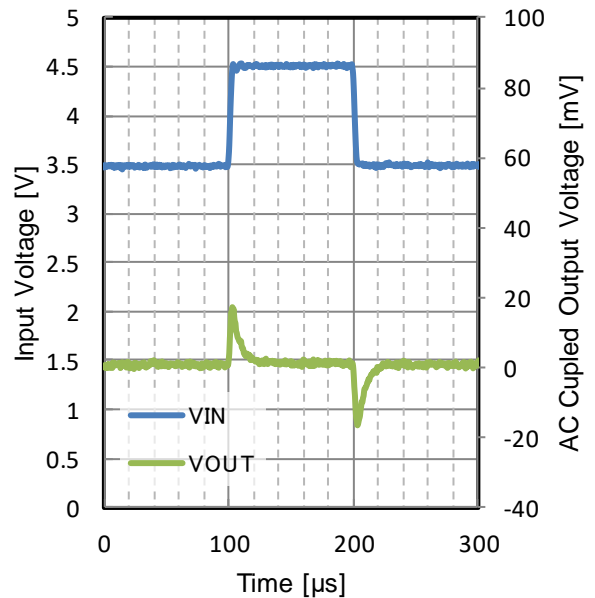

Figure 204. Line Transient
 $V_{OUT} = 3.0\text{ V}$
 $t_R = t_F = 1\text{ V}/\mu\text{s}$, $I_{OUT} = 100\text{ mA}$, $C_{OUT} = 10\text{ }\mu\text{F}$
 $T_j = 150\text{ }^\circ\text{C}$

Typical Performance Curves (BU30JA3DG-C) - continued

Unless otherwise specified, $V_{IN} = 4.0\text{ V}$, $V_{EN} = 1.5\text{ V}$, $C_{IN} = 0.1\text{ }\mu\text{F}$, $C_{OUT} = 1.0\text{ }\mu\text{F}$

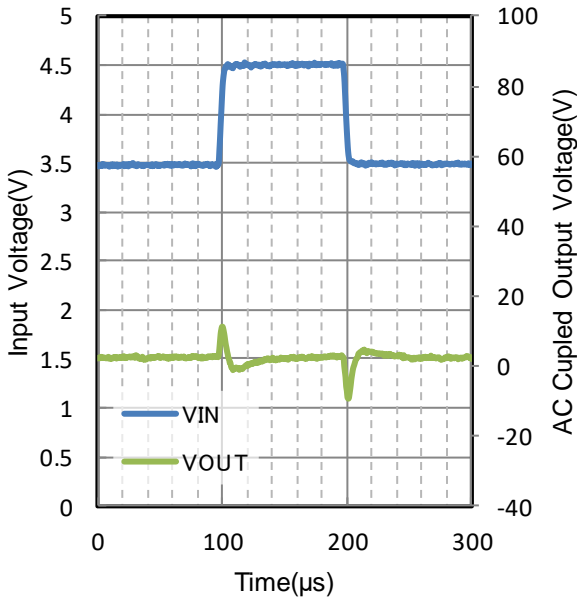

Figure 205. Line Transient
 $V_{OUT} = 3.0\text{ V}$
 $t_R = t_F = 1\text{ V}/\mu\text{s}$, $I_{OUT} = 300\text{ mA}$, $C_{OUT} = 10\text{ }\mu\text{F}$
 $T_j = -40\text{ }^\circ\text{C}$

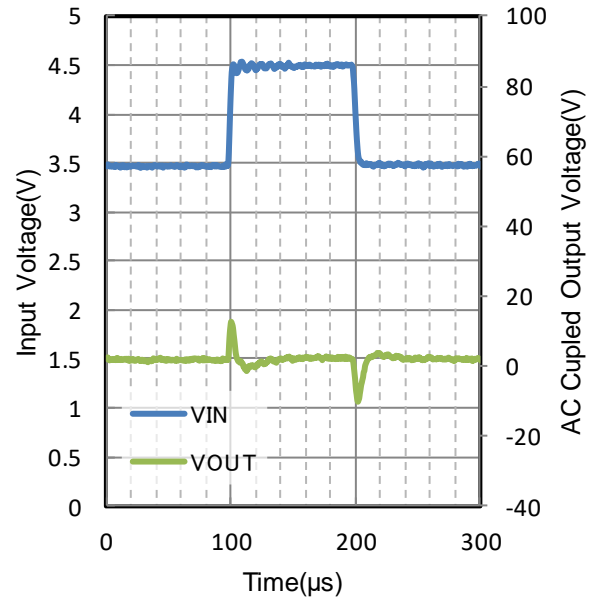

Figure 206. Line Transient
 $V_{OUT} = 3.0\text{ V}$
 $t_R = t_F = 1\text{ V}/\mu\text{s}$, $I_{OUT} = 300\text{ mA}$, $C_{OUT} = 10\text{ }\mu\text{F}$
 $T_j = 25\text{ }^\circ\text{C}$

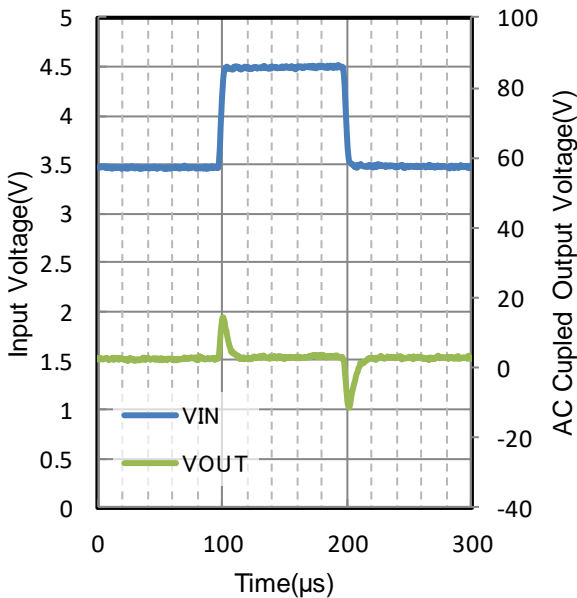

Figure 207. Line Transient
 $V_{OUT} = 3.0\text{ V}$
 $t_R = t_F = 1\text{ V}/\mu\text{s}$, $I_{OUT} = 300\text{ mA}$, $C_{OUT} = 10\text{ }\mu\text{F}$
 $T_j = 85\text{ }^\circ\text{C}$

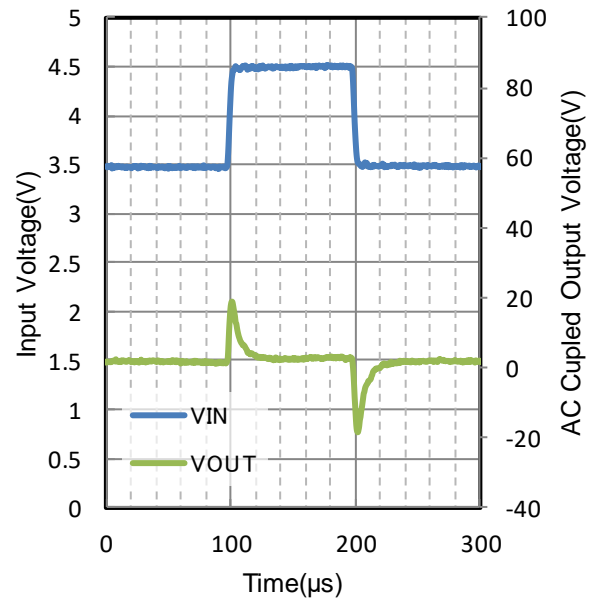

Figure 208. Line Transient
 $V_{OUT} = 3.0\text{ V}$
 $t_R = t_F = 1\text{ V}/\mu\text{s}$, $I_{OUT} = 300\text{ mA}$, $C_{OUT} = 10\text{ }\mu\text{F}$
 $T_j = 150\text{ }^\circ\text{C}$

Typical Performance Curves (BU30JA3DG-C) - continued

Unless otherwise specified, $V_{IN} = 4.0\text{ V}$, $V_{EN} = 1.5\text{ V}$, $C_{IN} = 0.1\text{ }\mu\text{F}$, $C_{OUT} = 1.0\text{ }\mu\text{F}$

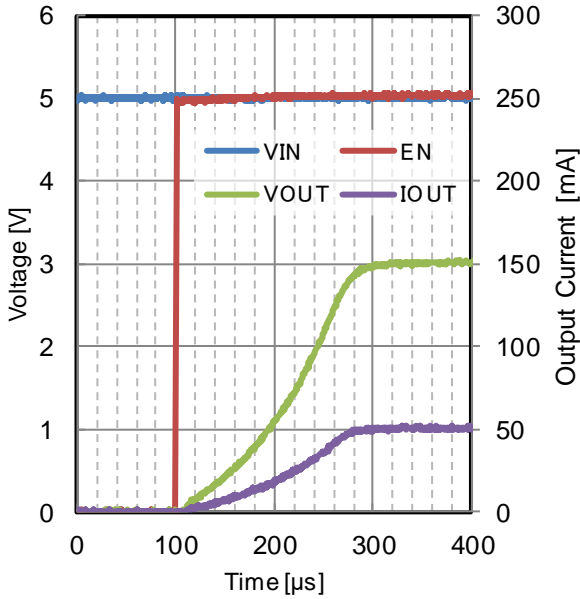

Figure 209. Start Up Waveform
 $V_{OUT} = 3.0\text{ V}$, $I_{OUT} = 50\text{ mA}$
 $V_{IN} = 5.0\text{ V}$, $C_{OUT} = 10\text{ }\mu\text{F}$
 $T_j = -40\text{ }^\circ\text{C}$

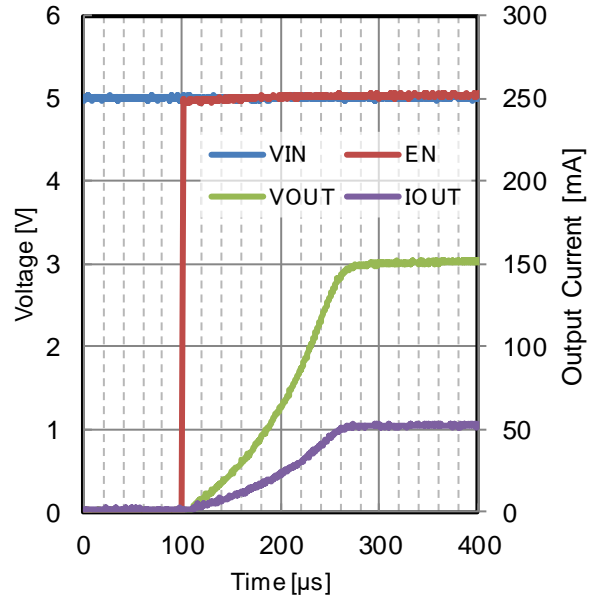

Figure 210. Start Up Waveform
 $V_{OUT} = 3.0\text{ V}$, $I_{OUT} = 50\text{ mA}$
 $V_{IN} = 5.0\text{ V}$, $C_{OUT} = 10\text{ }\mu\text{F}$
 $T_j = 25\text{ }^\circ\text{C}$

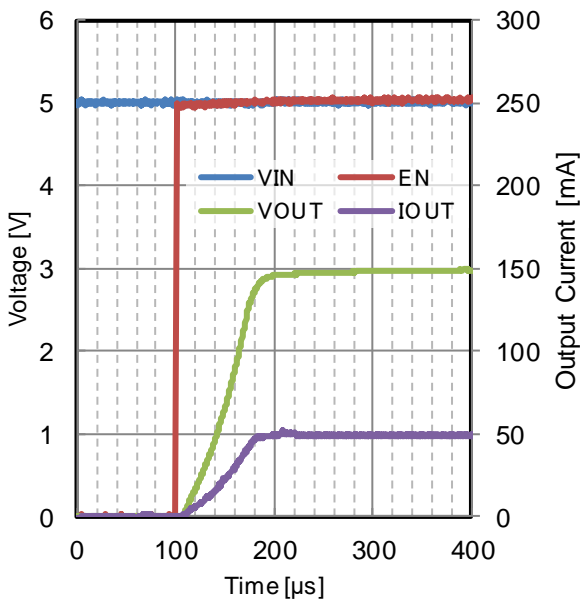

Figure 211. Start Up Waveform
 $V_{OUT} = 3.0\text{ V}$, $I_{OUT} = 50\text{ mA}$
 $V_{IN} = 5.0\text{ V}$, $C_{OUT} = 10\text{ }\mu\text{F}$
 $T_j = 150\text{ }^\circ\text{C}$

Typical Performance Curves (BU33JA3DG-C)

Unless otherwise specified, $V_{IN} = 4.3\text{ V}$, $V_{EN} = 1.5\text{ V}$, $C_{IN} = 0.1\text{ }\mu\text{F}$, $C_{OUT} = 1.0\text{ }\mu\text{F}$

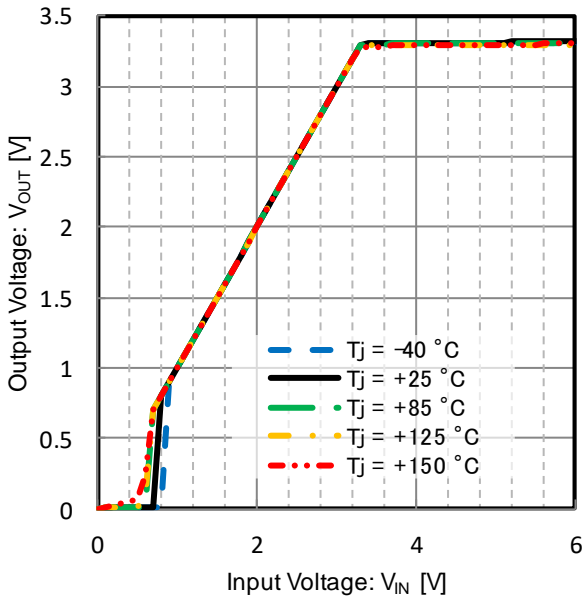

Figure 212. Output Voltage vs Input Voltage
 $V_{OUT} = 3.3\text{ V}$

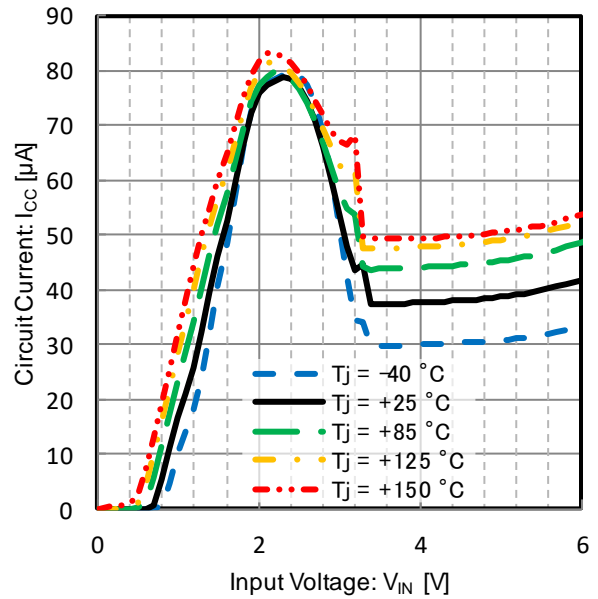

Figure 213. Circuit Current vs Input Voltage
 $V_{OUT} = 3.3\text{ V}$

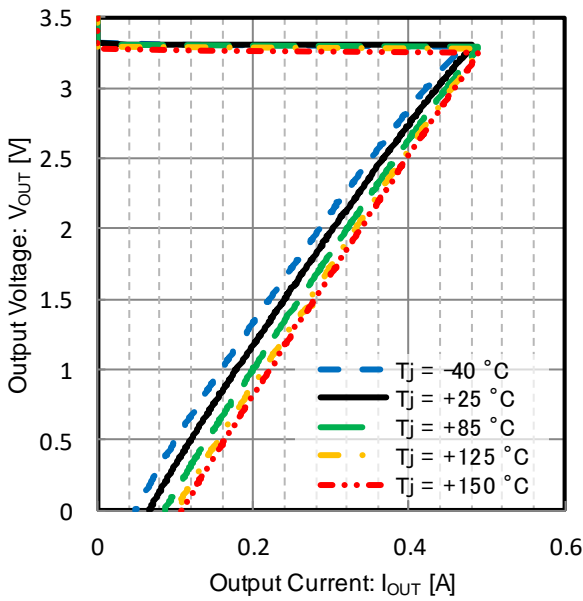

Figure 214. Output Current Limit
 $V_{OUT} = 3.3\text{ V}$

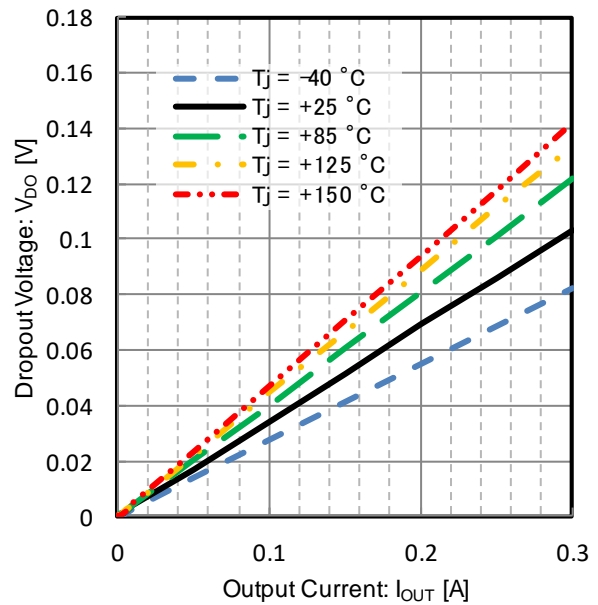

Figure 215. Dropout Voltage vs Output Current
 $V_{IN} = 3.234\text{ V}$, $V_{OUT} = 3.3\text{ V}$

Typical Performance Curves (BU33JA3DG-C)- continued

Unless otherwise specified, $V_{IN} = 4.3\text{ V}$, $V_{EN} = 1.5\text{ V}$, $C_{IN} = 0.1\text{ }\mu\text{F}$, $C_{OUT} = 1.0\text{ }\mu\text{F}$

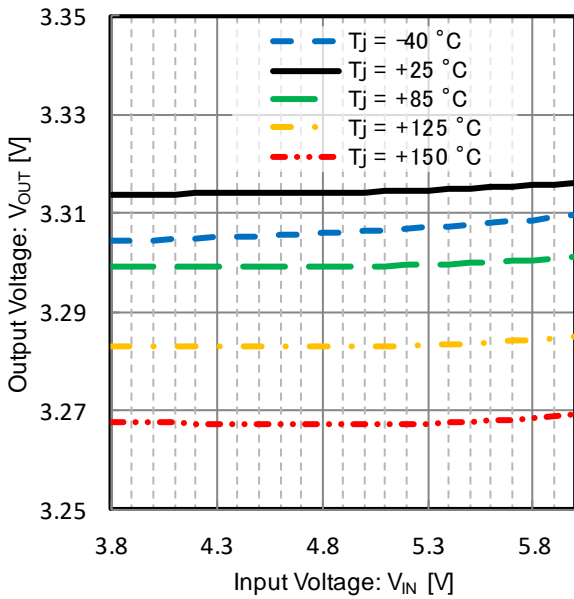

Figure 216. Line Regulation
 $V_{OUT} = 3.3\text{ V}$, $I_{OUT} = 50\text{ mA}$

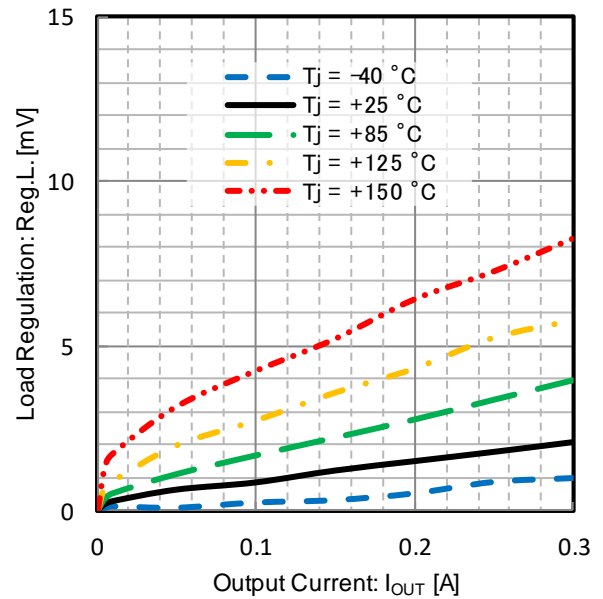

Figure 217. Load Regulation
 $V_{OUT} = 3.3\text{ V}$, $I_{OUT} = 1\text{ mA}$ to 300 mA

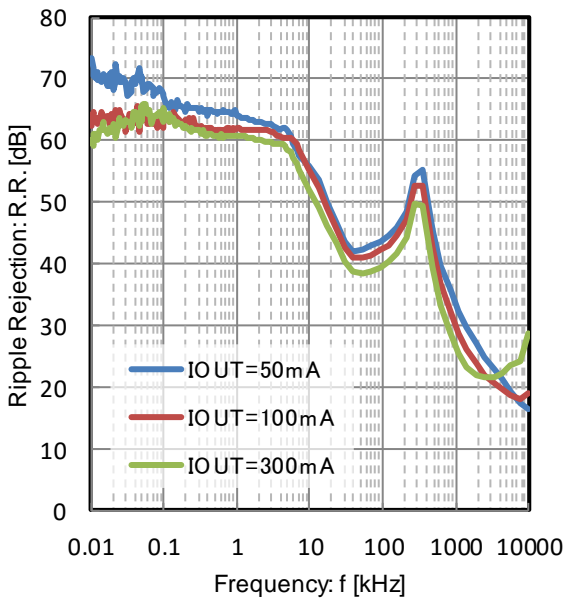

Figure 218. PSRR vs Frequency and Output Current
 $C_{IN} = 0\text{ }\mu\text{F}$, $C_{OUT} = 10\text{ }\mu\text{F}$
 $V_{OUT} = 3.3\text{ V}$

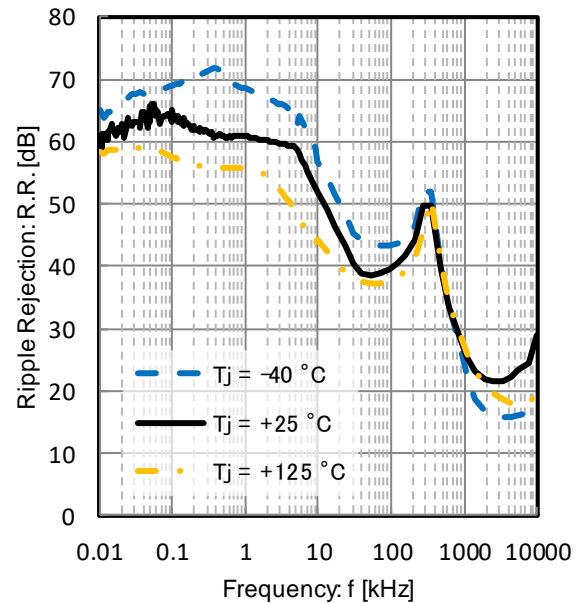

Figure 219. PSRR vs Frequency and Temperature
 $C_{IN} = 0\text{ }\mu\text{F}$, $C_{OUT} = 10\text{ }\mu\text{F}$
 $V_{IN} = 5\text{ V}$, $V_{OUT} = 3.3\text{ V}$, $I_{OUT} = 300\text{ mA}$

Typical Performance Curves (BU33JA3DG-C) - continued

Unless otherwise specified, $V_{IN} = 4.3\text{ V}$, $V_{EN} = 1.5\text{ V}$, $C_{IN} = 0.1\text{ }\mu\text{F}$, $C_{OUT} = 1.0\text{ }\mu\text{F}$

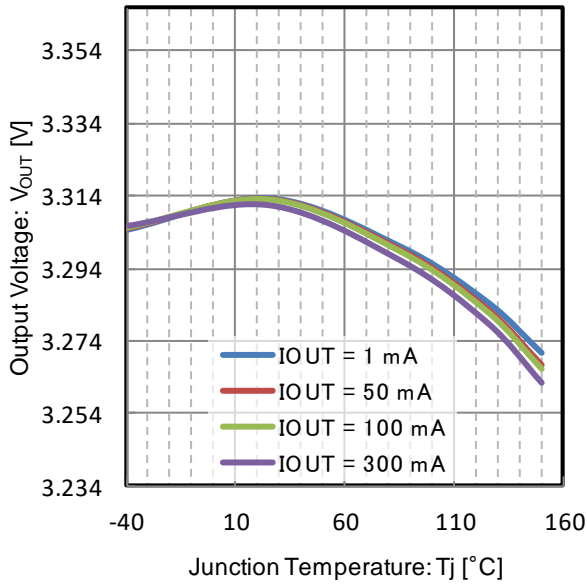

Figure 220. Output Voltage vs Junction temperature
 $V_{OUT} = 3.3\text{ V}$

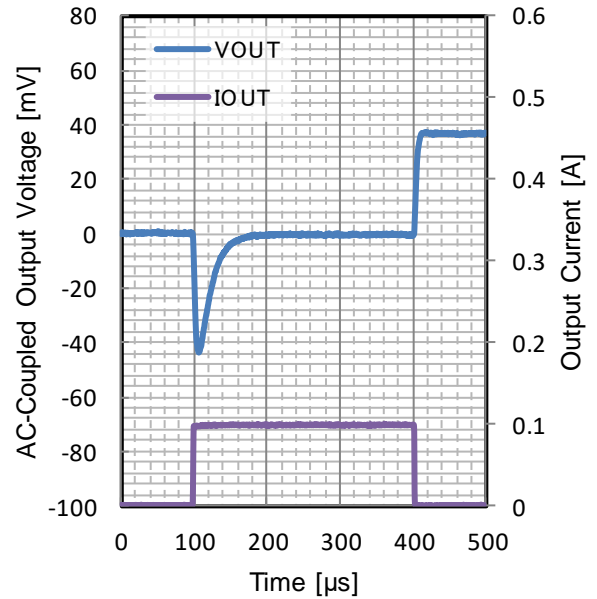

Figure 221. Load Transient
 $V_{OUT} = 3.3\text{ V}$
 $t_R = t_F = 1\text{ }\mu\text{s}$, $I_{OUT} = 0\text{ mA to }100\text{ mA}$, $C_{OUT} = 10\text{ }\mu\text{F}$
 $T_j = -40\text{ }^\circ\text{C}$

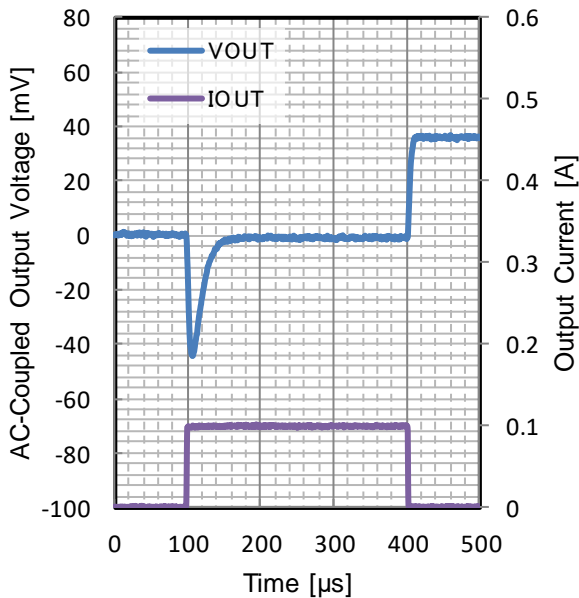

Figure 222. Load Transient
 $V_{OUT} = 3.3\text{ V}$
 $t_R = t_F = 1\text{ }\mu\text{s}$, $I_{OUT} = 0\text{ mA to }100\text{ mA}$, $C_{OUT} = 10\text{ }\mu\text{F}$
 $T_j = 25\text{ }^\circ\text{C}$

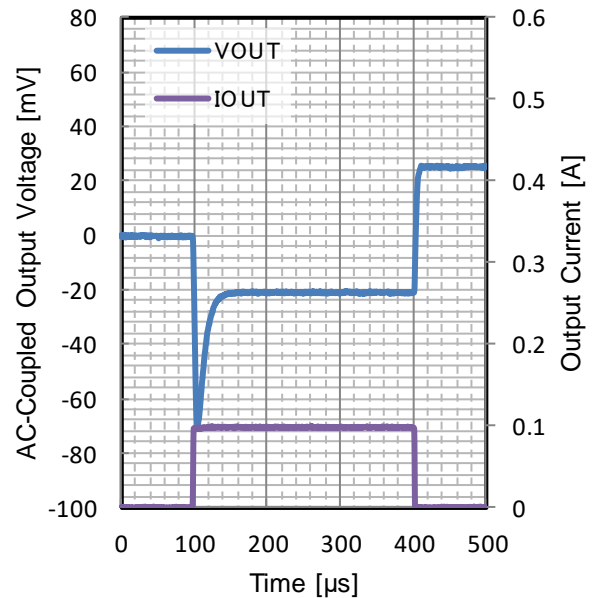

Figure 223. Load Transient
 $V_{OUT} = 3.3\text{ V}$
 $t_R = t_F = 1\text{ }\mu\text{s}$, $I_{OUT} = 0\text{ mA to }100\text{ mA}$, $C_{OUT} = 10\text{ }\mu\text{F}$
 $T_j = 150\text{ }^\circ\text{C}$

Typical Performance Curves (BU33JA3DG-C) - continued

Unless otherwise specified, $V_{IN} = 4.3\text{ V}$, $V_{EN} = 1.5\text{ V}$, $C_{IN} = 0.1\text{ }\mu\text{F}$, $C_{OUT} = 1.0\text{ }\mu\text{F}$

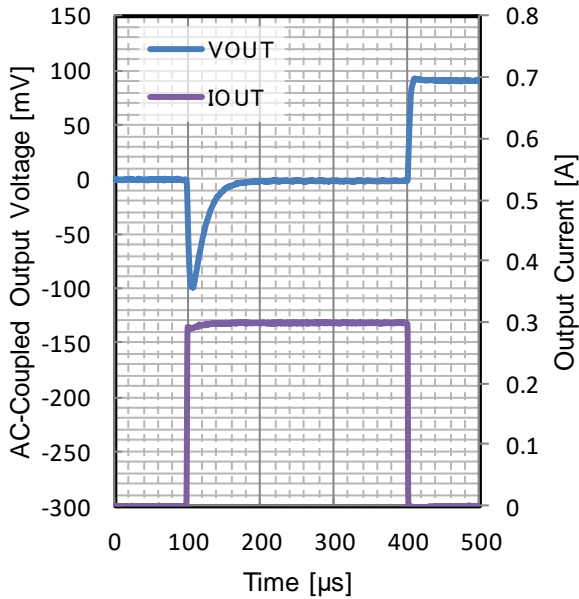

Figure 224. Load Transient

$V_{OUT} = 3.3\text{ V}$

$t_R = t_F = 1\text{ }\mu\text{s}$, $I_{OUT} = 0\text{ mA to }300\text{ mA}$, $C_{OUT} = 10\text{ }\mu\text{F}$
 $T_j = -40\text{ }^\circ\text{C}$

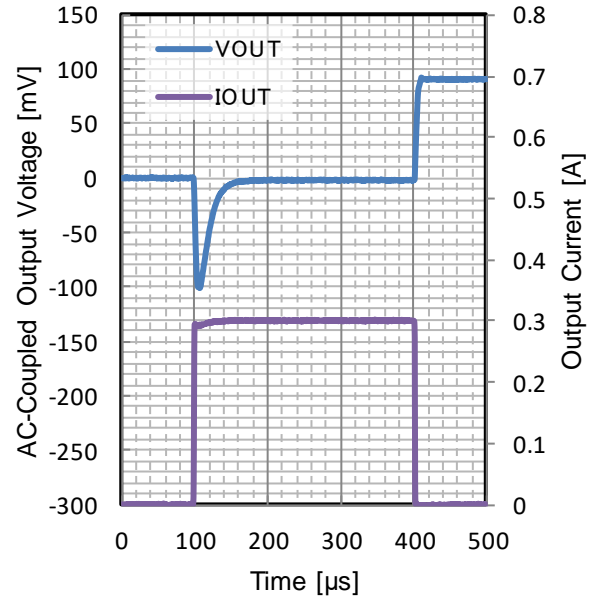

Figure 225. Load Transient

$V_{OUT} = 3.3\text{ V}$

$t_R = t_F = 1\text{ }\mu\text{s}$, $I_{OUT} = 0\text{ mA to }300\text{ mA}$, $C_{OUT} = 10\text{ }\mu\text{F}$
 $T_j = 25\text{ }^\circ\text{C}$

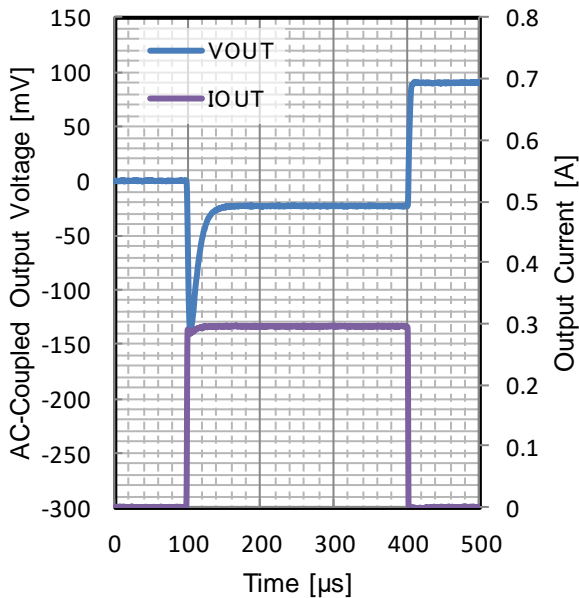

Figure 226. Load Transient

$V_{OUT} = 3.3\text{ V}$

$t_R = t_F = 1\text{ }\mu\text{s}$, $I_{OUT} = 0\text{ mA to }300\text{ mA}$, $C_{OUT} = 10\text{ }\mu\text{F}$
 $T_j = 150\text{ }^\circ\text{C}$

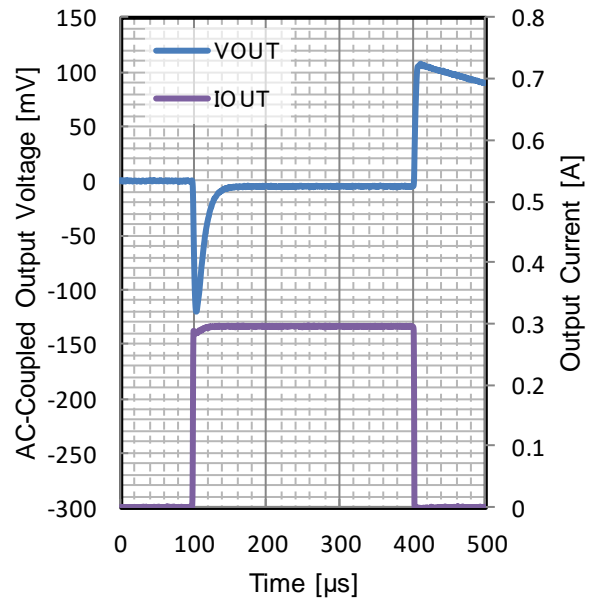

Figure 227. Load Transient

$V_{OUT} = 3.3\text{ V}$

$t_R = t_F = 1\text{ }\mu\text{s}$, $I_{OUT} = 1\text{ mA to }300\text{ mA}$, $C_{OUT} = 10\text{ }\mu\text{F}$
 $T_j = 150\text{ }^\circ\text{C}$

Typical Performance Curves (BU33JA3DG-C) - continued

Unless otherwise specified, $V_{IN} = 4.3\text{ V}$, $V_{EN} = 1.5\text{ V}$, $C_{IN} = 0.1\text{ }\mu\text{F}$, $C_{OUT} = 1.0\text{ }\mu\text{F}$

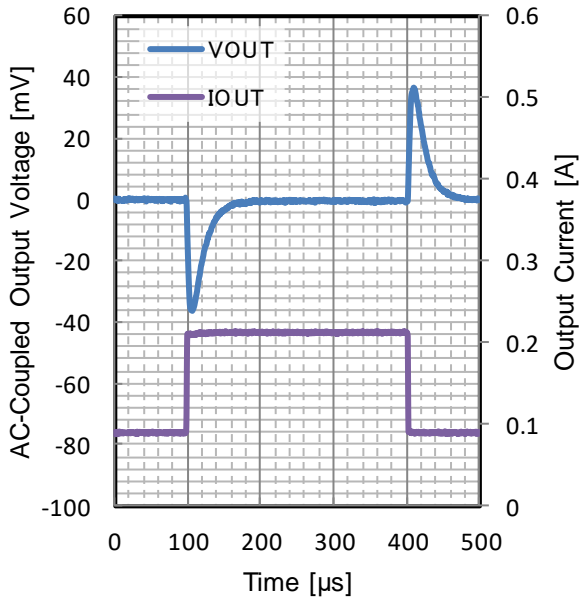

Figure 228. Load Transient

$V_{OUT} = 3.3\text{ V}$

$t_r = t_f = 1\text{ }\mu\text{s}$, $I_{OUT} = 90\text{ mA to }210\text{ mA}$, $C_{OUT} = 10\text{ }\mu\text{F}$
 $T_j = -40\text{ }^\circ\text{C}$

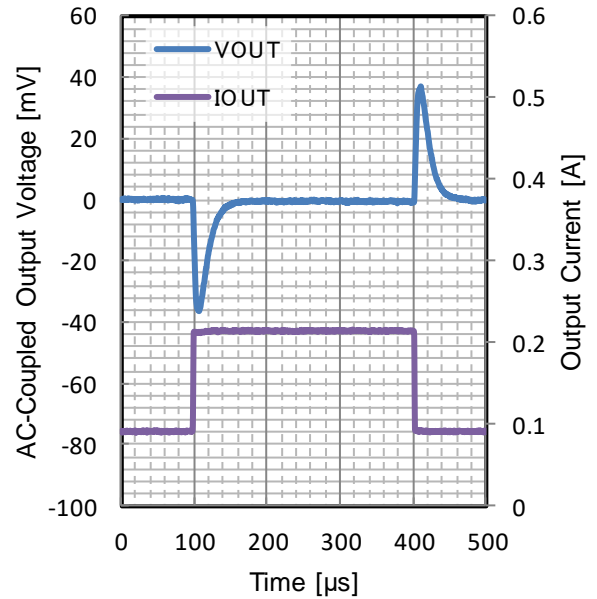

Figure 229. Load Transient

$V_{OUT} = 3.3\text{ V}$

$t_r = t_f = 1\text{ }\mu\text{s}$, $I_{OUT} = 90\text{ mA to }210\text{ mA}$, $C_{OUT} = 10\text{ }\mu\text{F}$
 $T_j = 25\text{ }^\circ\text{C}$

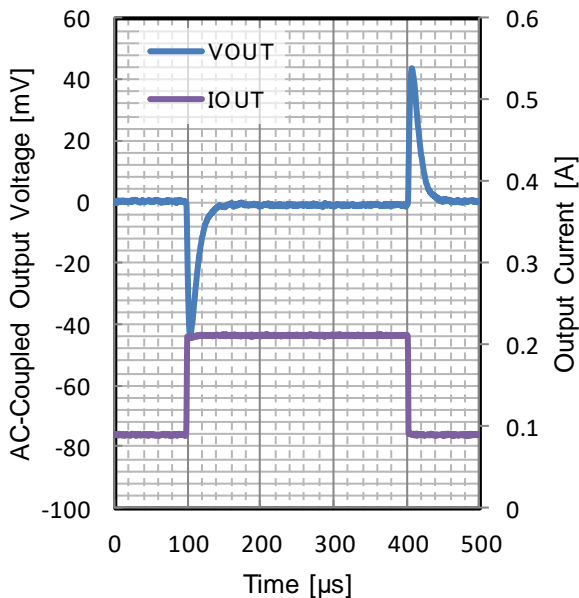

Figure 230. Load Transient

$V_{OUT} = 3.3\text{ V}$

$t_r = t_f = 1\text{ }\mu\text{s}$, $I_{OUT} = 90\text{ mA to }210\text{ mA}$, $C_{OUT} = 10\text{ }\mu\text{F}$
 $T_j = 150\text{ }^\circ\text{C}$

Typical Performance Curves (BU33JA3DG-C) - continued

Unless otherwise specified, $V_{IN} = 4.3\text{ V}$, $V_{EN} = 1.5\text{ V}$, $C_{IN} = 0.1\text{ }\mu\text{F}$, $C_{OUT} = 1.0\text{ }\mu\text{F}$

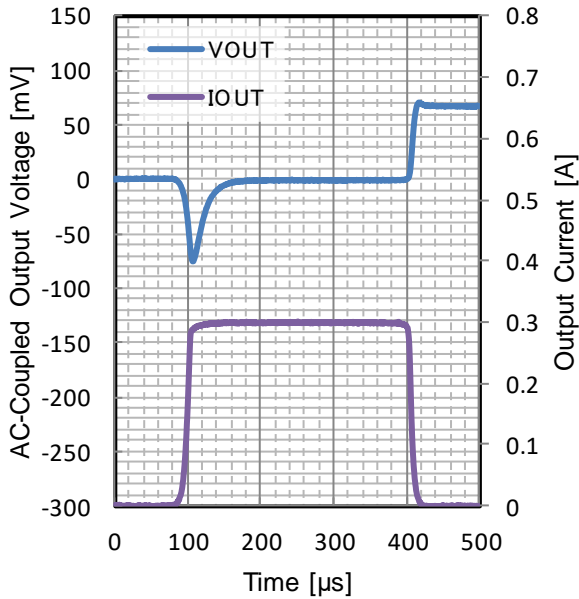

Figure 231. Load Transient

$V_{OUT} = 3.3\text{ V}$

$t_R = t_F = 10\text{ }\mu\text{s}$, $I_{OUT} = 0\text{ mA to }300\text{ mA}$, $C_{OUT} = 10\text{ }\mu\text{F}$
 $T_j = -40\text{ }^\circ\text{C}$

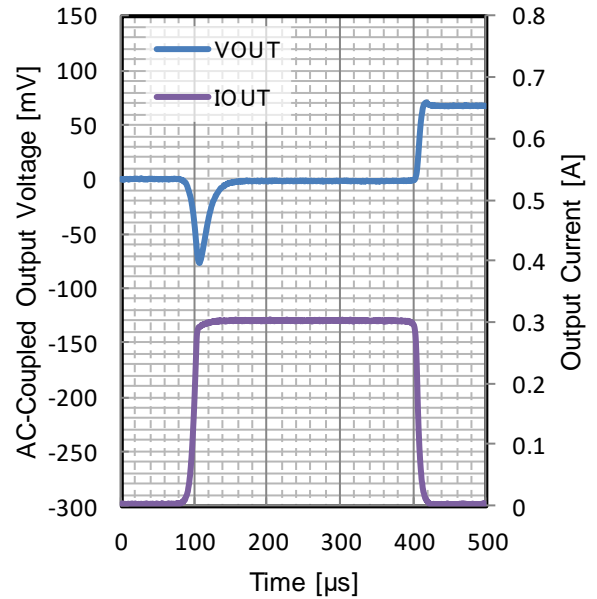

Figure 232. Load Transient

$V_{OUT} = 3.3\text{ V}$

$t_R = t_F = 10\text{ }\mu\text{s}$, $I_{OUT} = 0\text{ mA to }300\text{ mA}$, $C_{OUT} = 10\text{ }\mu\text{F}$
 $T_j = 25\text{ }^\circ\text{C}$

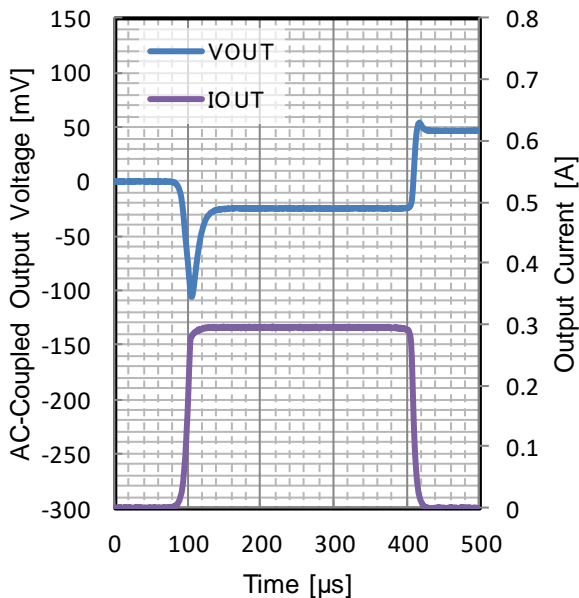

Figure 233. Load Transient

$V_{OUT} = 3.3\text{ V}$

$t_R = t_F = 10\text{ }\mu\text{s}$, $I_{OUT} = 0\text{ mA to }300\text{ mA}$, $C_{OUT} = 10\text{ }\mu\text{F}$
 $T_j = 150\text{ }^\circ\text{C}$

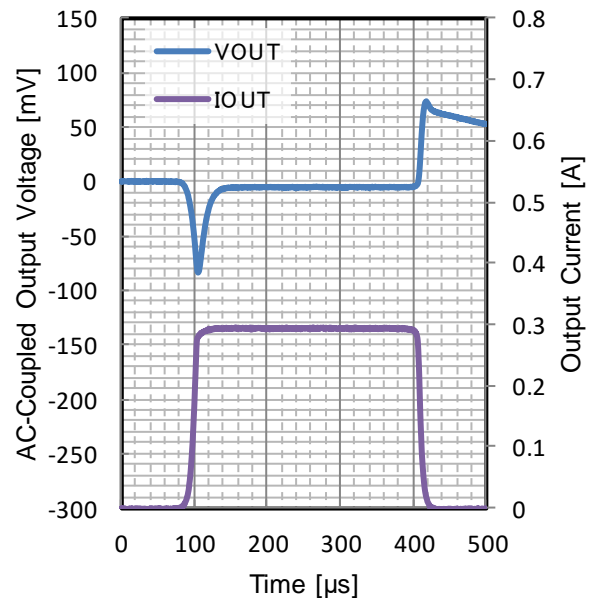

Figure 234. Load Transient

$V_{OUT} = 3.3\text{ V}$

$t_R = t_F = 10\text{ }\mu\text{s}$, $I_{OUT} = 1\text{ mA to }300\text{ mA}$, $C_{OUT} = 10\text{ }\mu\text{F}$
 $T_j = 150\text{ }^\circ\text{C}$

Typical Performance Curves (BU33JA3DG-C) - continued

Unless otherwise specified, $V_{IN} = 4.3\text{ V}$, $V_{EN} = 1.5\text{ V}$, $C_{IN} = 0.1\text{ }\mu\text{F}$, $C_{OUT} = 1.0\text{ }\mu\text{F}$

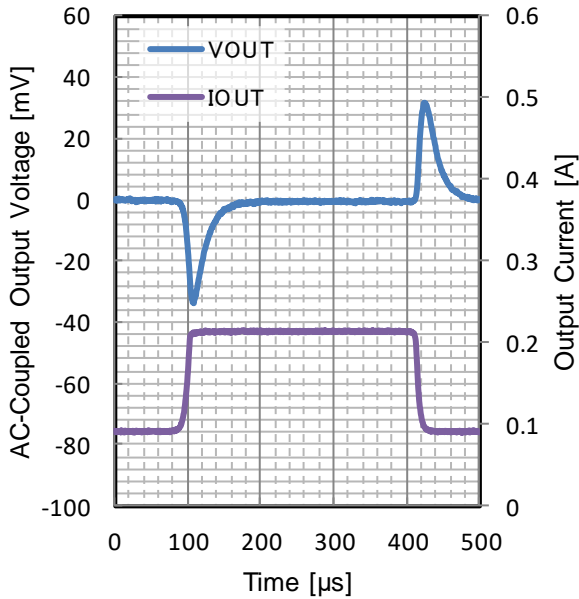

Figure 235. Load Transient

$V_{OUT} = 3.3\text{ V}$

$t_R = t_F = 10\text{ }\mu\text{s}$, $I_{OUT} = 90\text{ mA}$ to 210 mA , $C_{OUT} = 10\text{ }\mu\text{F}$
 $T_j = -40\text{ }^\circ\text{C}$

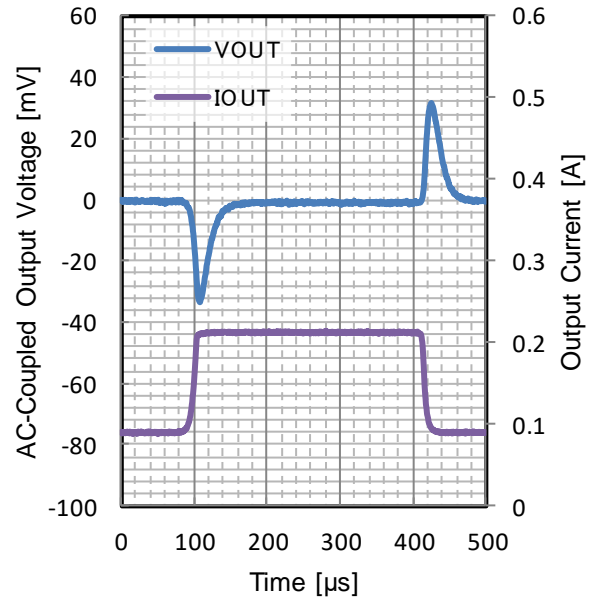

Figure 236. Load Transient

$V_{OUT} = 3.3\text{ V}$

$t_R = t_F = 10\text{ }\mu\text{s}$, $I_{OUT} = 90\text{ mA}$ to 210 mA , $C_{OUT} = 10\text{ }\mu\text{F}$
 $T_j = 25\text{ }^\circ\text{C}$

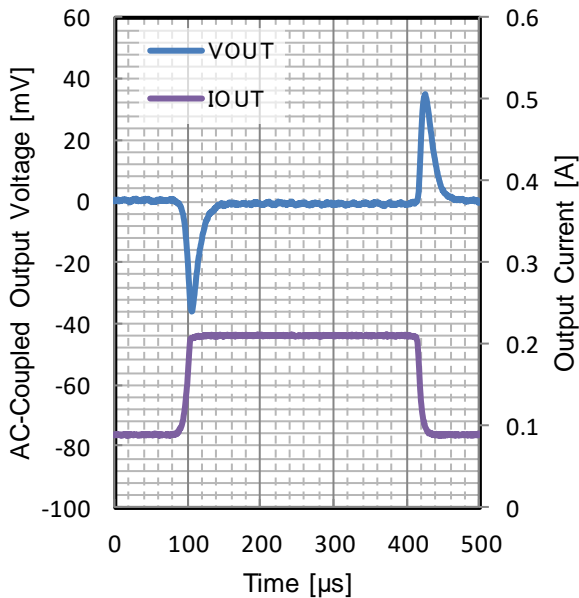

Figure 237. Load Transient

$V_{OUT} = 3.3\text{ V}$

$t_R = t_F = 10\text{ }\mu\text{s}$, $I_{OUT} = 90\text{ mA}$ to 210 mA , $C_{OUT} = 10\text{ }\mu\text{F}$
 $T_j = 150\text{ }^\circ\text{C}$

Typical Performance Curves (BU33JA3DG-C) - continued

Unless otherwise specified, $V_{IN} = 4.3\text{ V}$, $V_{EN} = 1.5\text{ V}$, $C_{IN} = 0.1\text{ }\mu\text{F}$, $C_{OUT} = 1.0\text{ }\mu\text{F}$

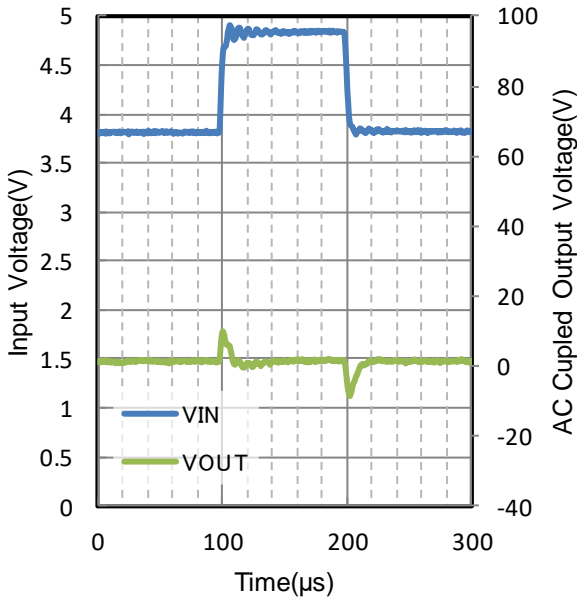

Figure 238. Line Transient

$V_{OUT} = 3.3\text{ V}$

$t_R = t_F = 1\text{ V}/\mu\text{s}$, $I_{OUT} = 50\text{ mA}$, $C_{OUT} = 10\text{ }\mu\text{F}$
 $T_j = -40\text{ }^\circ\text{C}$

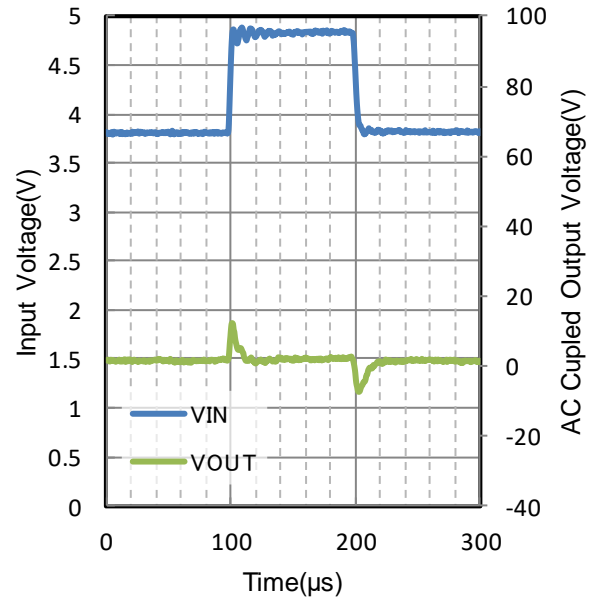

Figure 239. Line Transient

$V_{OUT} = 3.3\text{ V}$

$t_R = t_F = 1\text{ V}/\mu\text{s}$, $I_{OUT} = 50\text{ mA}$, $C_{OUT} = 10\text{ }\mu\text{F}$
 $T_j = 25\text{ }^\circ\text{C}$

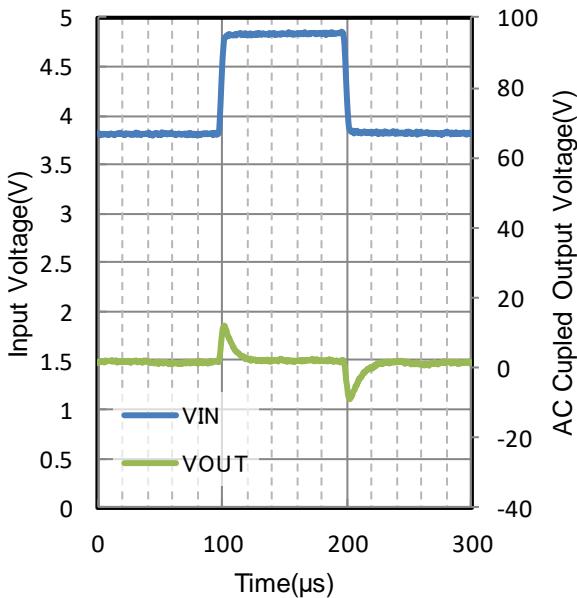

Figure 240. Line Transient

$V_{OUT} = 3.3\text{ V}$

$t_R = t_F = 1\text{ V}/\mu\text{s}$, $I_{OUT} = 50\text{ mA}$, $C_{OUT} = 10\text{ }\mu\text{F}$
 $T_j = 85\text{ }^\circ\text{C}$

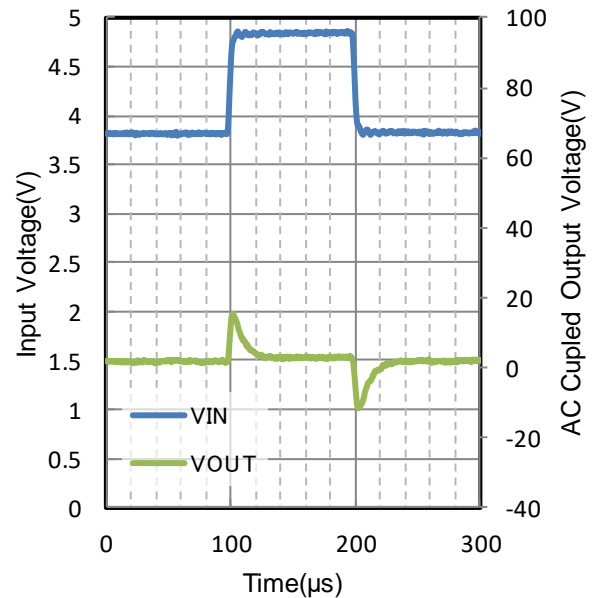

Figure 241. Line Transient

$V_{OUT} = 3.3\text{ V}$

$t_R = t_F = 1\text{ V}/\mu\text{s}$, $I_{OUT} = 50\text{ mA}$, $C_{OUT} = 10\text{ }\mu\text{F}$
 $T_j = 150\text{ }^\circ\text{C}$

Typical Performance Curves (BU33JA3DG-C) - continued

Unless otherwise specified, $V_{IN} = 4.3\text{ V}$, $V_{EN} = 1.5\text{ V}$, $C_{IN} = 0.1\text{ }\mu\text{F}$, $C_{OUT} = 1.0\text{ }\mu\text{F}$

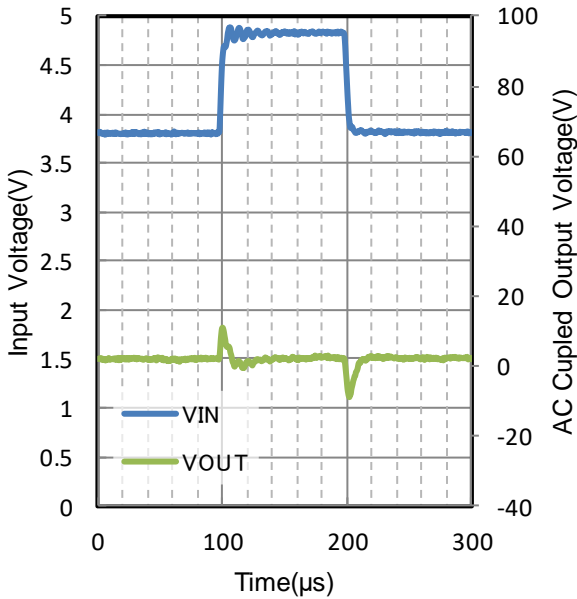

Figure 242. Line Transient
 $V_{OUT} = 3.3\text{ V}$
 $t_R = t_F = 1\text{ V}/\mu\text{s}$, $I_{OUT} = 100\text{ mA}$, $C_{OUT} = 10\text{ }\mu\text{F}$
 $T_j = -40\text{ }^\circ\text{C}$

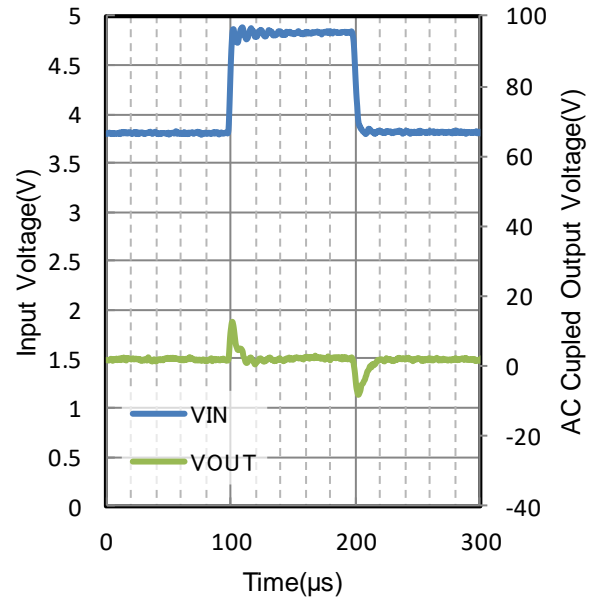

Figure 243. Line Transient
 $V_{OUT} = 3.3\text{ V}$
 $t_R = t_F = 1\text{ V}/\mu\text{s}$, $I_{OUT} = 100\text{ mA}$, $C_{OUT} = 10\text{ }\mu\text{F}$
 $T_j = 25\text{ }^\circ\text{C}$

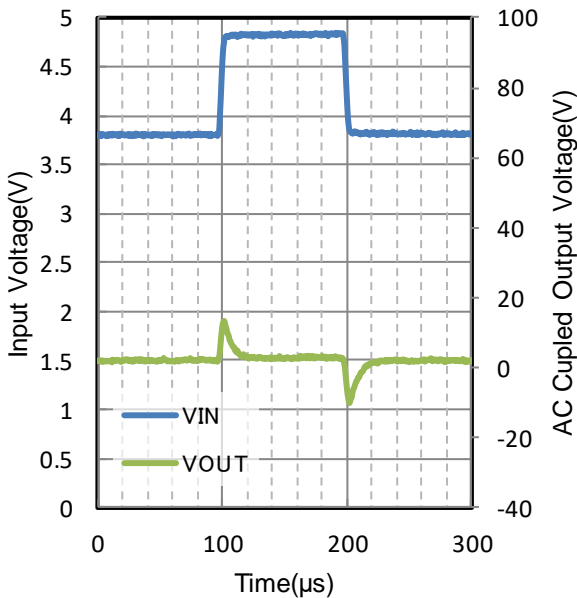

Figure 244. Line Transient
 $V_{OUT} = 3.3\text{ V}$
 $t_R = t_F = 1\text{ V}/\mu\text{s}$, $I_{OUT} = 100\text{ mA}$, $C_{OUT} = 10\text{ }\mu\text{F}$
 $T_j = 85\text{ }^\circ\text{C}$

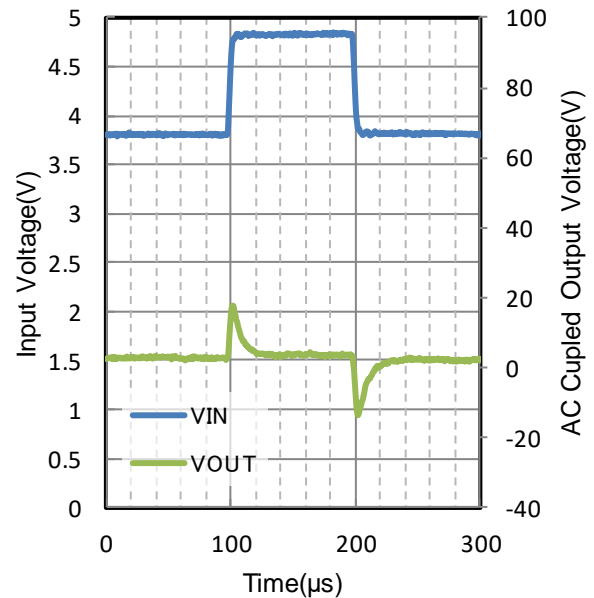

Figure 245. Line Transient
 $V_{OUT} = 3.3\text{ V}$
 $t_R = t_F = 1\text{ V}/\mu\text{s}$, $I_{OUT} = 100\text{ mA}$, $C_{OUT} = 10\text{ }\mu\text{F}$
 $T_j = 150\text{ }^\circ\text{C}$

Typical Performance Curves (BU33JA3DG-C) - continued

Unless otherwise specified, $V_{IN} = 4.3\text{ V}$, $V_{EN} = 1.5\text{ V}$, $C_{IN} = 0.1\text{ }\mu\text{F}$, $C_{OUT} = 1.0\text{ }\mu\text{F}$

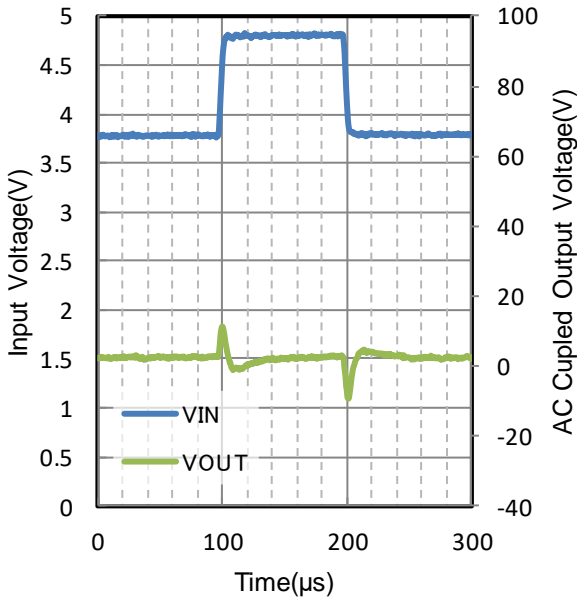

Figure 246. Line Transient
 $V_{OUT} = 3.3\text{ V}$
 $t_R = t_F = 1\text{ V}/\mu\text{s}$, $I_{OUT} = 300\text{ mA}$, $C_{OUT} = 10\text{ }\mu\text{F}$
 $T_j = -40\text{ }^\circ\text{C}$

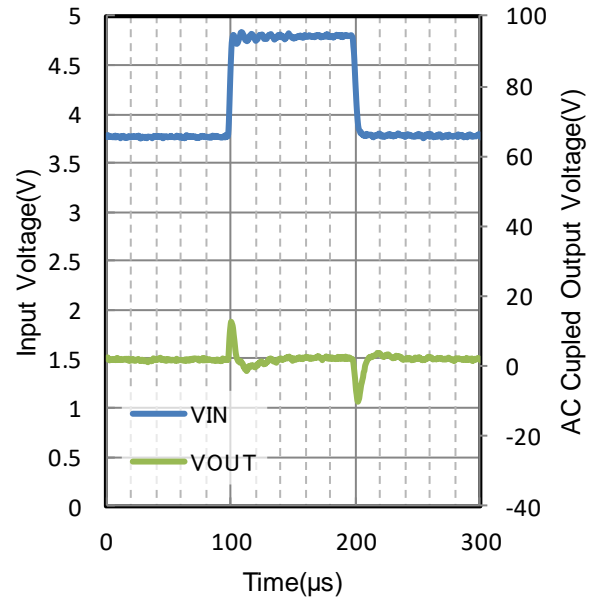

Figure 247. Line Transient
 $V_{OUT} = 3.3\text{ V}$
 $t_R = t_F = 1\text{ V}/\mu\text{s}$, $I_{OUT} = 300\text{ mA}$, $C_{OUT} = 10\text{ }\mu\text{F}$
 $T_j = 25\text{ }^\circ\text{C}$

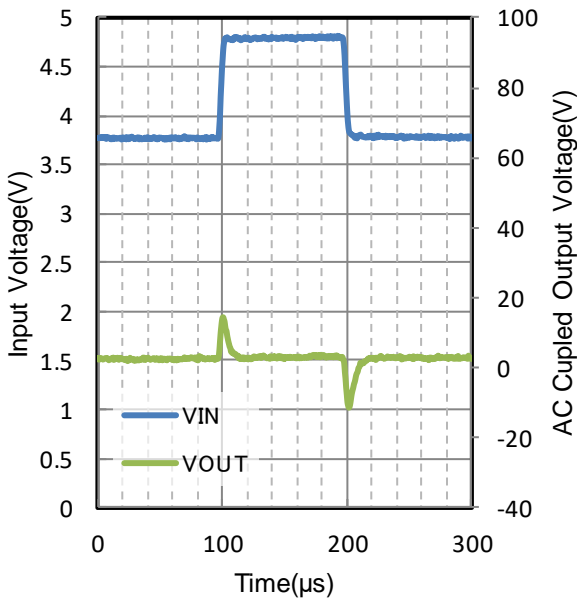

Figure 248. Line Transient
 $V_{OUT} = 3.3\text{ V}$
 $t_R = t_F = 1\text{ V}/\mu\text{s}$, $I_{OUT} = 300\text{ mA}$, $C_{OUT} = 10\text{ }\mu\text{F}$
 $T_j = 85\text{ }^\circ\text{C}$

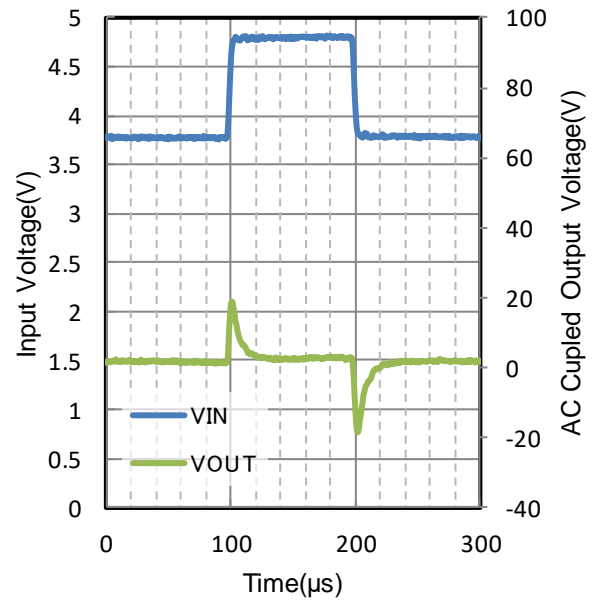

Figure 249. Line Transient
 $V_{OUT} = 3.3\text{ V}$
 $t_R = t_F = 1\text{ V}/\mu\text{s}$, $I_{OUT} = 300\text{ mA}$, $C_{OUT} = 10\text{ }\mu\text{F}$
 $T_j = 150\text{ }^\circ\text{C}$

Typical Performance Curves (BU33JA3DG-C) - continued

Unless otherwise specified, $V_{IN} = 4.3\text{ V}$, $V_{EN} = 1.5\text{ V}$, $C_{IN} = 0.1\text{ }\mu\text{F}$, $C_{OUT} = 1.0\text{ }\mu\text{F}$

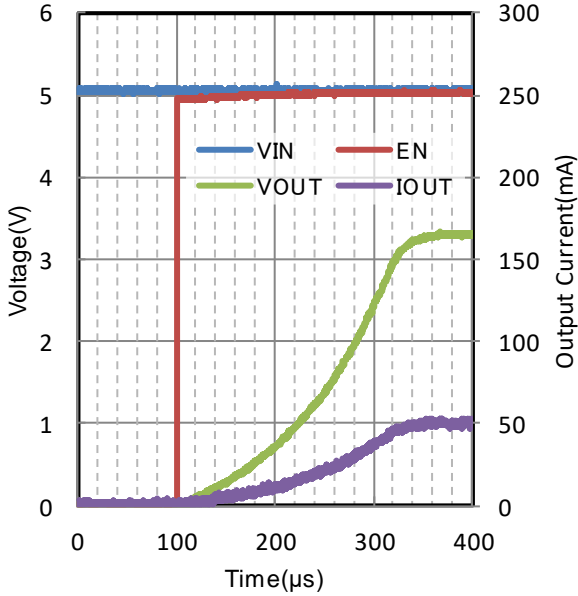

Figure 250. Start Up Waveform
 $V_{OUT} = 3.3\text{ V}$, $I_{OUT} = 50\text{ mA}$
 $V_{IN} = 5.0\text{ V}$, $C_{OUT} = 10\text{ }\mu\text{F}$
 $T_j = -40\text{ }^\circ\text{C}$

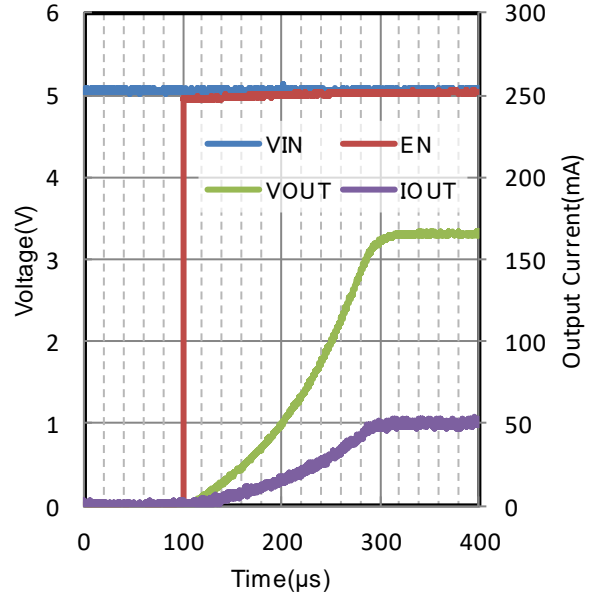

Figure 251. Start Up Waveform
 $V_{OUT} = 3.3\text{ V}$, $I_{OUT} = 50\text{ mA}$
 $V_{IN} = 5.0\text{ V}$, $C_{OUT} = 10\text{ }\mu\text{F}$
 $T_j = 25\text{ }^\circ\text{C}$

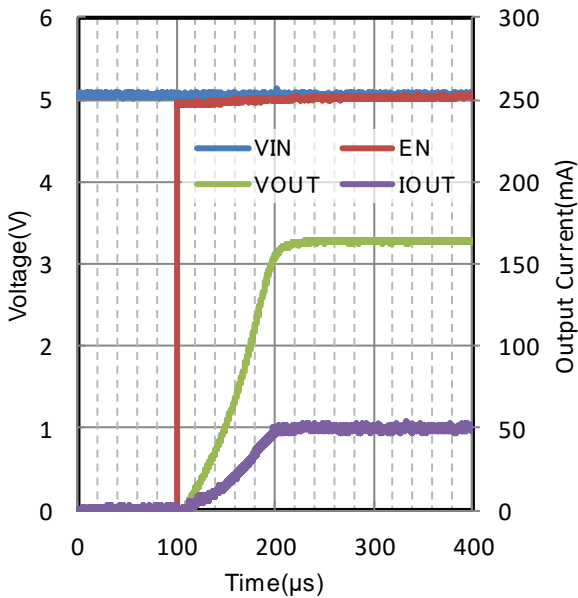

Figure 252. Start Up Waveform
 $V_{OUT} = 3.3\text{ V}$, $I_{OUT} = 50\text{ mA}$
 $V_{IN} = 5.0\text{ V}$, $C_{OUT} = 10\text{ }\mu\text{F}$
 $T_j = 150\text{ }^\circ\text{C}$

Typical Performance Curves

Unless otherwise specified, $V_{IN} = V_{OUT} + 1.0\text{ V}$, $V_{EN} = 1.5\text{ V}$, $C_{IN} = 0.1\text{ }\mu\text{F}$, $C_{OUT} = 1.0\text{ }\mu\text{F}$

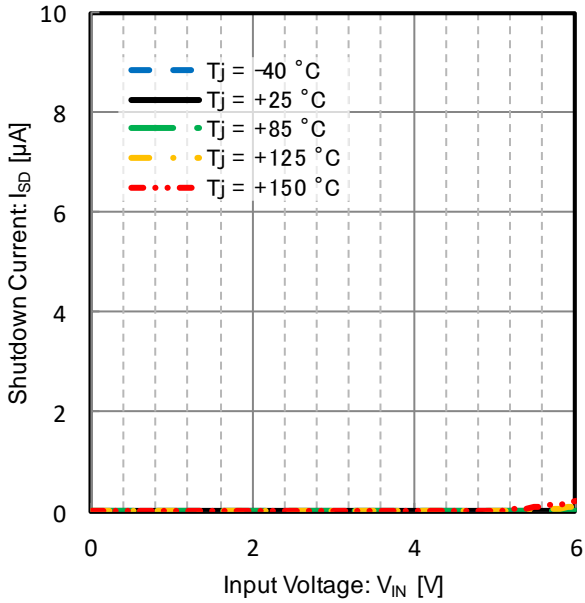

Figure 253. Shutdown Current vs Input Voltage ($V_{EN} = 0\text{ V}$)

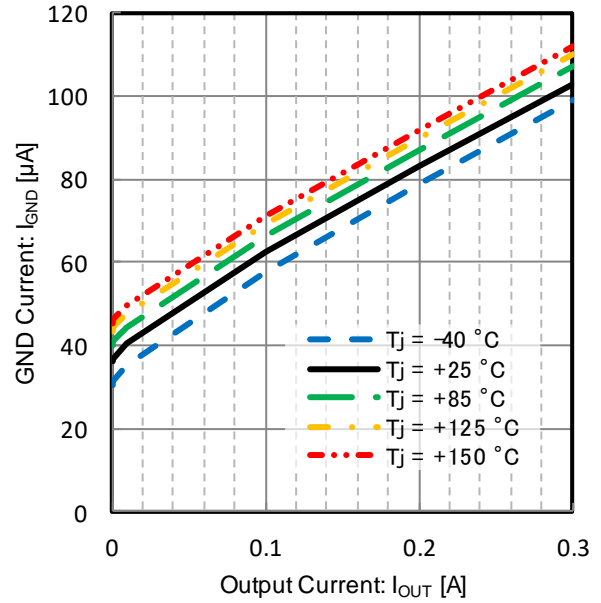

Figure 254. GND Current vs Output Current

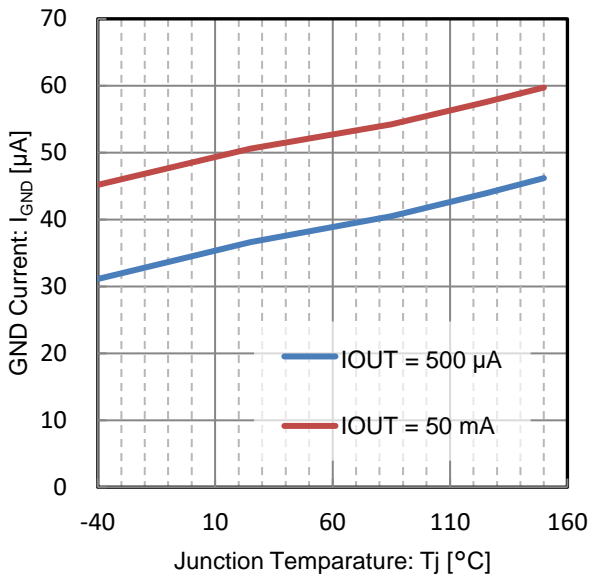

Figure 255. GND Current vs Junction Temperature

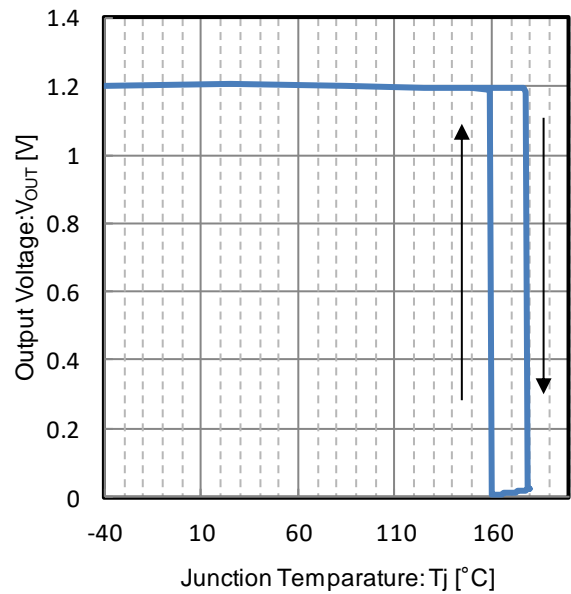

Figure 256. Thermal Shutdown Activation ($V_{OUT} = 1.2\text{ V}$)

Typical Performance Curves - continued

Unless otherwise specified, $V_{IN} = V_{OUT} + 1.0\text{ V}$, $V_{EN} = 1.5\text{ V}$, $C_{IN} = 0.1\text{ }\mu\text{F}$, $C_{OUT} = 1.0\text{ }\mu\text{F}$

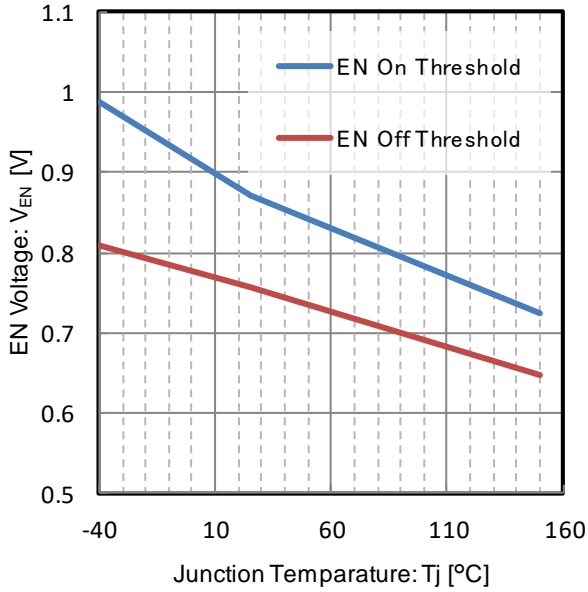

Figure 257. EN Threshold Voltage vs Junction Temperature

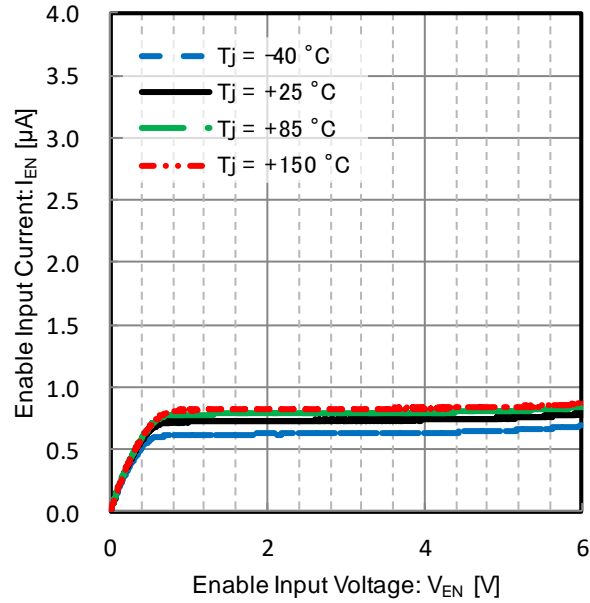

Figure 258. Enable Input Current vs Enable Input Voltage

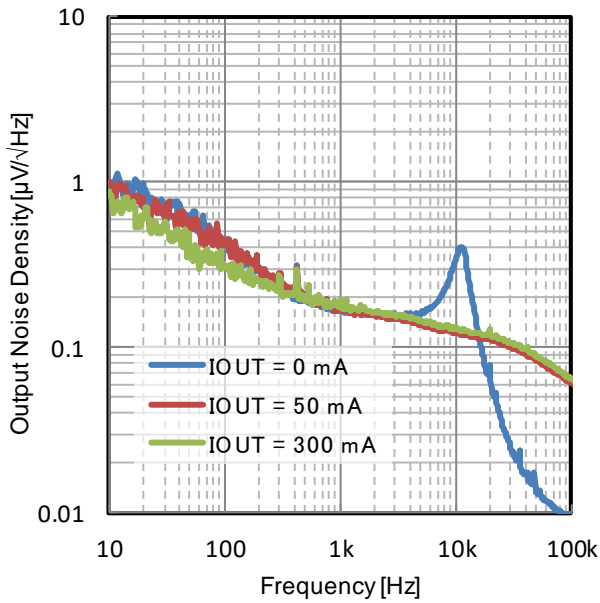

Figure 259. Output Noise Density vs Frequency
 $V_{OUT} = 1.2\text{ V}$

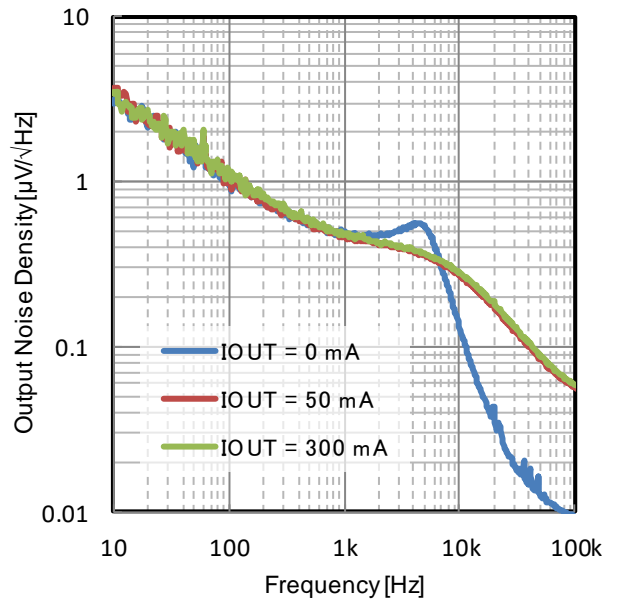

Figure 260. Output Noise Density vs Frequency
 $V_{OUT} = 3.3\text{ V}$

Application and Implementation

Notice: The following information is given as a reference or hint for the application and the implementation. Therefore, it does not guarantee its operation on a specific function, accuracy, or external components in the application. Application should be designed with sufficient margin by enough understanding the characteristics of the external components, e.g., capacitor, and also by appropriate verification in the actual operating conditions.

Selection of External Components

Input Pin Capacitor

If the battery is placed far from the regulator or the impedance of the input-side is high, higher capacitance is required for the input capacitor in order to prevent the voltage-drop at the input line. The input capacitor and its capacitance should be selected depending on the line impedance which is between the input pin and the smoothing filter circuit of the power supply. Therefore, an appropriate capacitance value which is selected by the consideration of the input impedance is different for each application. Generally, the capacitor with capacitance value of 0.1 μF (Min) with good high frequency characteristic is recommended for this regulator.

In addition, to prevent regulator characteristics from getting affected by deviation or variation of the external capacitor characteristic, all input capacitors mentioned above is recommended to have a good DC bias characteristic and a stable temperature characteristic (approximately $\pm 15\%$, e.g., X7R and X8R), satisfying high absolute maximum voltage rating based on EIA standard. This capacitor must be placed close to the input pin and is better to be mounted on the same board side of the regulator.

Output Pin Capacitor

The output capacitor is mandatory for the regulator in order to realize stable operation. The output capacitor with capacitance value $\geq 0.47\ \mu\text{F}$ (Min) and ESR up to 1 Ω (Max) is required between the output pin and the GND pin.

Appropriately selected capacitance value and ESR for the output capacitor can improve the transient behavior of the regulator and can also keep the stability with better regulation loop. The correlation of the output capacitance value and ESR is shown in the graph Output Capacitance C_{OUT} , ESR Available Area on the next page. As described in the graph, this regulator is designed to be stable with ceramic capacitors such as MLCC, with capacitance value from 0.47 μF to 47 μF , and with ESR value in the range of approximately 0 Ω to 1 Ω . The frequency range of ESR can be generally considered as within about 10 kHz to 100 kHz.

Note that the provided stable area of the capacitance value and ESR in the graph is obtained under a specific set of conditions which is based on the measurement result of a single IC on our board with a resistive load. In the actual environment, the stability is affected by wire impedance on the board, input power supply impedance, and by load impedance. Therefore, also note that a careful evaluation with actual application, actual usage environment, and actual conditions is necessary to confirm the actual stability of the system.

Generally, in the transient event which exceeds the gain bandwidth of regulation loop caused by the input voltage fluctuation or by the load fluctuation, the transient response ability of the regulator depends on the capacitance value of the output capacitor. Basically, capacitance value 0.47 μF (Min) and more for the output capacitor is recommended as shown in the table of Output Capacitance C_{OUT} , ESR Available Area. It is expected that the bigger the capacitance value is the better the transient response ability will be in high frequency. Various type of capacitors can be used for this high capacity of the output capacitor including electrolytic capacitor, electro-conductive polymer capacitor, and tantalum capacitor. Note that depending on the type of capacitors, the size of ESR ($\leq 1\ \Omega$) absolute value, temperature dependency of capacitance value, and increasing ESR at cold temperature needs to be taken into consideration.

Similar to the input pin capacitor, to avoid the influence of the deviation and variation caused by the external capacitor characteristic, all output capacitor mentioned above must select good DC bias characteristic and temperature characteristic (approximately $\pm 15\%$, e.g., X7R, X8R) satisfying high absolute maximum voltage rating based on EIA standard. These capacitors should be placed close to the output pin and mounted on the same board side of the regulator, not to be influenced by implement impedance.

Application and Implementation - continued

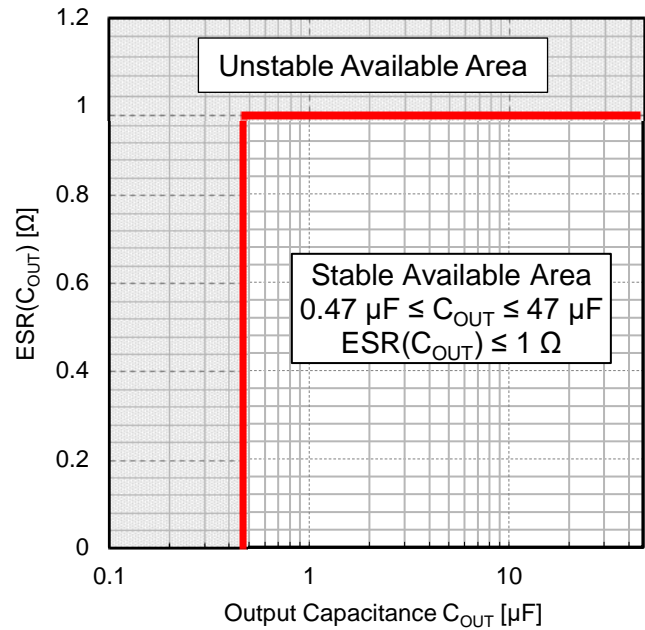

Figure 261. Output Capacitance C_{OUT} , ESR Stable Available Area
 ($-40\text{ }^{\circ}\text{C} \leq T_j \leq +150\text{ }^{\circ}\text{C}$, $1.7\text{ V} \leq V_{IN} \leq 6.5\text{ V}$, $V_{EN} = 1.5\text{ V}$, $I_{OUT} = 0\text{ mA to } 300\text{ mA}$)

Typical Application

Parameter	Symbol	Reference Value for Application
Output Current Range	I_{OUT}	$I_{OUT} \leq 300\text{ mA}$
Output Voltage Range	V_{OUT}	1.2 V, 1.5 V, 1.8 V, 2.5 V, 3.0 V, 3.3 V
Output Capacitor	C_{OUT}	1.0 μF
Input Voltage	V_{IN}	5.0 V
Input Capacitor <i>(Note 1)</i>	C_{IN}	0.1 μF
Enable Mode Voltage	V_{ENH}	1.1 V to V_{IN}
Disable Mode Voltage	V_{ENL}	0 V to 0.5 V

(Note 1) If the inductance of power supply line is high, please adjust input capacitor value.

Application and Implementation - continued

Surge Voltage Protection for Linear Regulators

The following shows some helpful tips to protect ICs from the possibility of surge being input which exceeds absolute maximum rating.

Positive Surge to the Input

If there is any potential risk that positive surge higher than absolute maximum rating, e.g., 6.5 V, may be applied to the input, a Zener Diode should be insert between the VIN and the GND to protect the device as shown in Figure 262.

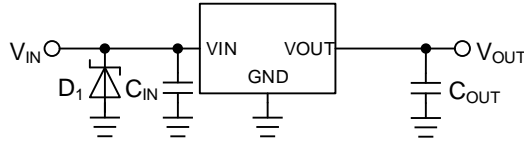

Figure 262. Surges Higher than 6.5 V is applied to the Input

Negative Surge to the Input

If there is any potential risk that negative surge lower than the absolute maximum rating, e.g., -0.3 V, may be applied to the input, a Schottky Diode should be insert between the VIN and the GND to protect the device as shown in Figure 263.

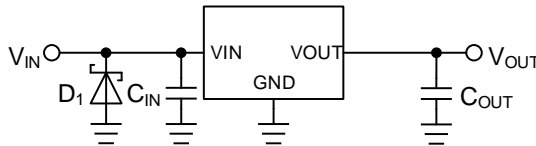

Figure 263. Surges Lower than -0.3 V is applied to the Input

Reverse Voltage Protection for Linear Regulators

A linear regulator which is one of the integrated circuits (IC) operates normally in the condition that higher input voltage is always supplied than the output voltage. However, there is a possibility of abnormal situation to occur where the output voltage becomes higher than the input voltage. As for the input and output, voltage and current condition may be reversed due to reverse polarity connection and certain inductor component. If the countermeasure is not implemented, it may cause damage to the IC. The following describe protection method of ICs in reverse voltage occasion.

Protection Against Reverse Input/Output Voltage

In the case where MOS FET is used as a pass transistor, a parasitic body diode generally exists between the drain-source. If the output voltage becomes higher than the input voltage and with its voltage difference exceeding V_F of the body diode, the reverse current flows from the output to the input via body diode as shown in Figure 264. Because this body diode is parasitic element, current which flows in it is not limited by the protection function. Therefore, too much reverse current may cause damage to degrade or may destroy the semiconductor elements of the regulator.

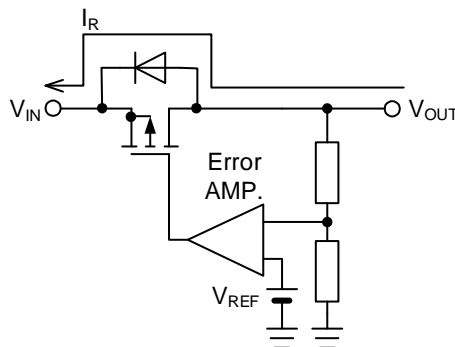

Figure 264. Reverse Current Path in a MOS Linear Regulator

Protection Against Reverse Input/Output Voltage – continued

To prevent the reverse current flow inside the IC, as an effective solution implement an external bypass diode as shown in Figure 265. Note that the bypass diode must be turned on prior to the body diode inside the IC. Forward voltage V_F lower than the internal body diode should be selected as external bypass diode. Should select a diode which has a rated reverse voltage greater than the IC's input maximum voltage and also which has a rated forward current greater than the anticipated reverse current in the actual application.

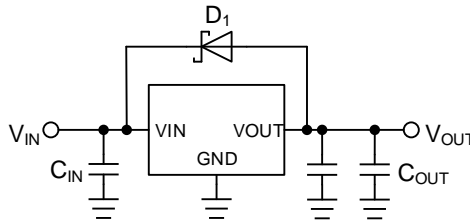

Figure 265. Bypass Diode for Reverse Current Diversion

A Schottky barrier diode which has a characteristic of low forward voltage (V_F) matches the requirement for the external diode to protect the IC from the reverse current, however it also has a characteristic that the leakage (I_R) caused by the reverse voltage can be bigger than other diodes. Therefore, it should be taken into a consideration when choosing it, because if I_R is large, it may cause current consumption to increase, or output voltage to rise in the light-load current condition. I_R of Schottky diode has positive temperature characteristic, which the details should be checked by the datasheet of the product, and careful confirmation of the behavior in the actual application is mandatory.

Even in the condition where the input/output voltage is inverted, if the VIN pin becomes open as shown in Figure 266, or if the VIN pin becomes high impedance as designed in the system, it cannot damage or degrade the parasitic element. It is because a reverse current via pass transistor becomes extremely low. In this case, therefore, the protection external diode is not necessary.

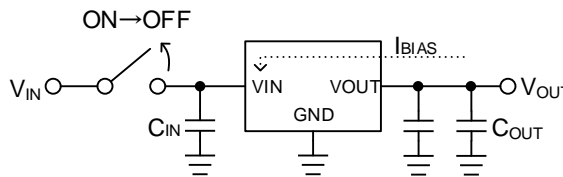

Figure 266. Open V_{IN}

Protection Against Input Reverse Voltage

When connecting input of IC to power supply, if accidentally reverse connect the plus and minus or if input may become lower than the GND pin, large current which flows in the internal electrostatic breakdown prevention diode set between VIN and GND as shown in Figure 267 may destroy the IC.

Simplest way to prevent this problem is to connect Schottky barrier diode or rectifier diode to power supply line in series as shown in Figure 268. However, it increases a power loss calculated as $V_F \times I_{IN}$, and due to forward voltage V_F of diode the voltage drop occurs to input voltage at the normal power supply line.

Generally, the Schottky barrier diode has lower V_F than rectifier diode and contributes to rather smaller power loss. If IC has load currents, the required input current to the IC is also bigger. In this case, this external diode generates heat more, therefore it should be taken into the consideration of a selection for diode with enough margin in power dissipation. On the other hands, in the reverse connection condition, a reverse current passes this diode, however, it can be negligible because its small amount.

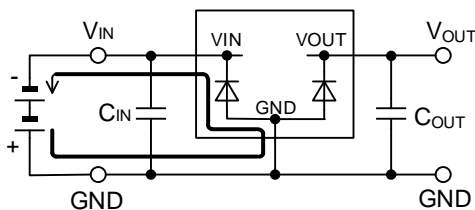

Figure 267. Current Path in Reverse Input Connection

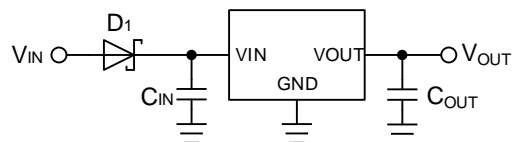

Figure 268. Protection against Reverse Polarity 1

Protection Against Input Reverse Voltage - continued

Figure 269 shows a circuit in which a P-channel MOSFET is connected in series to the power. The body diode (parasitic element) is located in the drain-source junction area of the MOSFET. The drop voltage in a forward connection is calculated by the on-state resistance of the MOSFET and the output current I_o . Because it is smaller than the drop voltage by the diode as shown in Figure 268, as a result power loss becomes less. No current flows in a reverse connection where the MOSFET remains off in Figure 269.

If the gate-source voltage exceeds maximum rating of MOSFET gate-source junction with considered derating curve, reduce the gate-source junction voltage by connecting resistor voltage divider as shown in Figure 270.

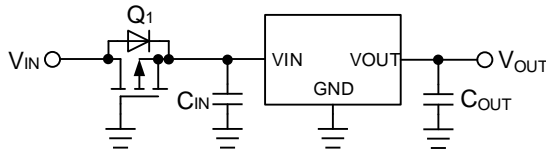

Figure 269. Protection against Reverse Polarity 2

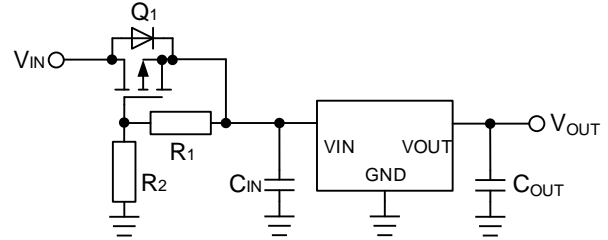

Figure 270. Protection against Reverse Polarity 3

Protection Against Reverse Output Voltage when Output Connect to an Inductor

If the output load is inductive, electrical energy accumulated in the inductive load is released to the ground at the moment that the output voltage is turned off. There is an ESD protection diode between output and ground pin inside the IC and large current flowing in this diode may eventually destruct the IC. To prevent this situation, connect a Schottky barrier diode in parallel to the diode as shown in Figure 271.

Further, if a long wire is used to connect the output pin of the IC and the load, observe the waveform on an oscilloscope to confirm whether the negative voltage is generated at the VOUT pin or not when the output voltage is turned off, since there is a possibility of the load to become inductive. An additional diode is required for a motor load that is affected by its counter electromotive force, as it produces an electrical current in a similar way.

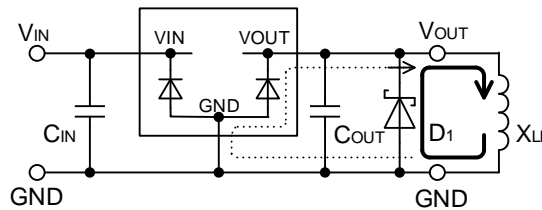

Figure 271. Current Path in Inductive Load (Output: Off)

Power Dissipation

SSOP5

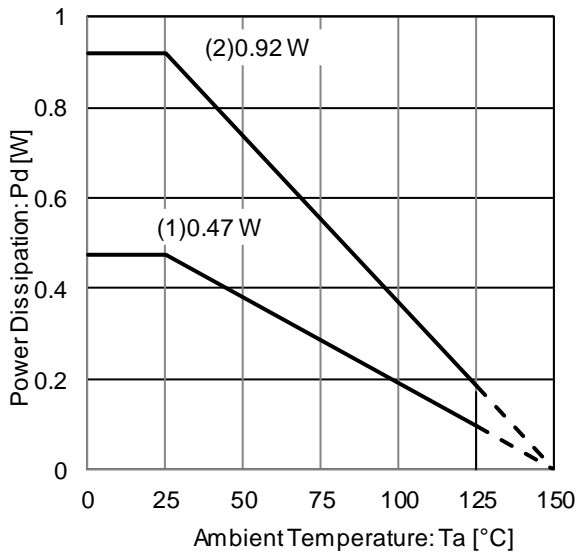

Figure 272. Power Dissipation Graph

(1): 1-layer PCB
 (Copper foil area on the reverse side of PCB: 0 mm × 0 mm)
 Board material: FR-4
 Board size: 114.3 mm × 76.2 mm × 1.57 mm
 Top copper foil: ROHM recommended footprint
 + wiring to measure, 2 oz. copper.

(2): 4-layer PCB
 (Copper foil area on the reverse side of PCB: 74.2 mm × 74.2 mm)
 Board material: FR-4
 Board size: 114.3 mm × 76.2 mm × 1.60 mm
 Top copper foil: ROHM recommended footprint
 + wiring to measure, 2 oz. copper.
 2 inner layers copper foil area of PCB:
 74.2 mm × 74.2 mm, 1 oz. copper.
 Copper foil area on the reverse side of PCB:
 74.2 mm × 74.2 mm, 2 oz. copper.

Condition (1): $\theta_{JA} = 264.4 \text{ }^\circ\text{C/W}$, $\Psi_{JT} \text{ (top center)} = 34 \text{ }^\circ\text{C/W}$
 Condition (2): $\theta_{JA} = 135.7 \text{ }^\circ\text{C/W}$, $\Psi_{JT} \text{ (top center)} = 27 \text{ }^\circ\text{C/W}$

Thermal Design

This product exposes a frame on the back side of the package for thermal efficiency improvement. The power consumption of the IC is decided by the dropout voltage condition, the load current and the current consumption. Refer to power dissipation curves illustrated in Figure 12 when using the IC in an environment of $T_a \geq 25^\circ\text{C}$. Even if the ambient temperature T_a is at 25°C , chip junction temperature (T_j) can be very high depending on the input voltage and the load current. Consider the design to be $T_j \leq T_{j\max} = 150^\circ\text{C}$ in whole operating temperature range.

Should by any condition the maximum junction temperature $T_{j\max} = 150^\circ\text{C}$ rating be exceeded by the temperature increase of the chip, it may result in deterioration of the properties of the chip. The thermal impedance in this specification is based on recommended PCB and measurement condition by JEDEC standard. Therefore, need to be careful because it might be different from the actual use condition. Verify the application and allow sufficient margins in the thermal design by the following method to calculate the junction temperature T_j . T_j can be calculated by either of the two following methods.

1. The following method is used to calculate the junction temperature T_j with ambient temperature T_a .

$$T_j = T_a + P_C \times \theta_{JA} \text{ [}^\circ\text{C]}]$$

Where:

- T_j is the Junction Temperature
- T_a is the Ambient Temperature
- P_C is the Power Consumption
- θ_{JA} is the Thermal Resistance (Junction to Ambient)

2. The following method is also used to calculate the junction temperature T_j with top center of case's (mold) temperature T_T .

$$T_j = T_T + P_C \times \Psi_{JT} \text{ [}^\circ\text{C]}]$$

Where:

- T_j is the Junction Temperature
- T_T is the Top Center of Case's (mold) Temperature
- P_C is the Power consumption
- Ψ_{JT} is the Thermal Resistance (Junction to Top Center of Case)

3. The following method is used to calculate the power consumption P_C (W).

$$P_C = (V_{IN} - V_{OUT}) \times I_{OUT} + V_{IN} \times I_{CC} \text{ [W]}$$

Where:

- P_C is the Power Consumption
- V_{IN} is the Input Voltage
- V_{OUT} is the Output Voltage
- I_{OUT} is the Load Current
- I_{CC} is the Current Consumption

Calculation Example

If $V_{IN} = 5.0\text{ V}$, $V_{OUT} = 3.3\text{ V}$, $I_{OUT} = 100\text{ mA}$, $I_{CC} = 37\ \mu\text{A}$, the power consumption P_C can be calculated as follows:

$$\begin{aligned} P_C &= (V_{IN} - V_{OUT}) \times I_{OUT} + V_{IN} \times I_{CC} \\ &= (5.0\text{ V} - 3.3\text{ V}) \times 100\text{ mA} + 5.0\text{ V} \times 37\ \mu\text{A} \\ &= 0.17\text{ W} \end{aligned}$$

At ambient temperature $T_a = 125^\circ\text{C}$,
the thermal impedance (Junction to Ambient) $\theta_{JA} = 135.7^\circ\text{C/W}$ (4-layer PCB)

$$\begin{aligned} T_j &= T_{a\max} + P_C \times \theta_{JA} \\ &= 125^\circ\text{C} + 0.17\text{ W} \times 135.7^\circ\text{C/W} \\ &= 148.1^\circ\text{C} \end{aligned}$$

When operating the IC, the top center of case's (mold) temperature $T_T = 100^\circ\text{C}$, $\Psi_{JT} = 27^\circ\text{C/W}$ (4-layer PCB)

$$\begin{aligned} T_j &= T_T + P_C \times \Psi_{JT} \\ &= 100^\circ\text{C} + 0.17\text{ W} \times 27^\circ\text{C/W} \\ &= 104.6^\circ\text{C} \end{aligned}$$

If it is difficult to ensure the margin by the calculations above, it is recommended to expand the copper foil area of the board, increasing the layer and thermal via between thermal land pad for optimum thermal performance.

I/O Equivalence Circuits

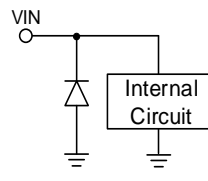
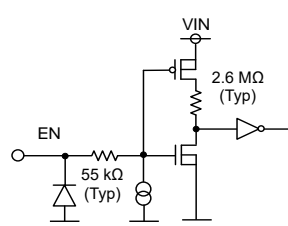
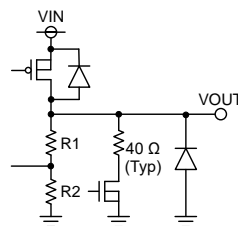
Pin 1 (VIN)	Pin 3 (EN)	Pin 5 (VOUT)																					
																							
		<table border="1" style="margin-left: auto; margin-right: auto;"> <thead> <tr> <th>Output Voltage [V] (Typ)</th> <th>R1 [kΩ] (Typ)</th> <th>R2 [kΩ] (Typ)</th> </tr> </thead> <tbody> <tr> <td>1.2</td> <td>99</td> <td>76</td> </tr> <tr> <td>1.5</td> <td>144</td> <td>76</td> </tr> <tr> <td>1.8</td> <td>190</td> <td>76</td> </tr> <tr> <td>2.5</td> <td>290</td> <td>76</td> </tr> <tr> <td>3.0</td> <td>364</td> <td>76</td> </tr> <tr> <td>3.3</td> <td>410</td> <td>76</td> </tr> </tbody> </table>	Output Voltage [V] (Typ)	R1 [kΩ] (Typ)	R2 [kΩ] (Typ)	1.2	99	76	1.5	144	76	1.8	190	76	2.5	290	76	3.0	364	76	3.3	410	76
Output Voltage [V] (Typ)	R1 [kΩ] (Typ)	R2 [kΩ] (Typ)																					
1.2	99	76																					
1.5	144	76																					
1.8	190	76																					
2.5	290	76																					
3.0	364	76																					
3.3	410	76																					

Operational Notes

1. Reverse Connection of Power Supply

Connecting the power supply in reverse polarity can damage the IC. Take precautions against reverse polarity when connecting the power supply, such as mounting an external diode between the power supply and the IC's power supply pins.

2. Power Supply Lines

Design the PCB layout pattern to provide low impedance supply lines. Furthermore, connect a capacitor to ground at all power supply pins. Consider the effect of temperature and aging on the capacitance value when using electrolytic capacitors.

3. Ground Voltage

Ensure that no pins are at a voltage below that of the ground pin at any time, even during transient condition.

4. Ground Wiring Pattern

When using both small-signal and large-current ground traces, the two ground traces should be routed separately but connected to a single ground at the reference point of the application board to avoid fluctuations in the small-signal ground caused by large currents. Also ensure that the ground traces of external components do not cause variations on the ground voltage. The ground lines must be as short and thick as possible to reduce line impedance.

5. Operating Conditions

The function and operation of the IC are guaranteed within the range specified by the recommended operating conditions. The characteristic values are guaranteed only under the conditions of each item specified by the electrical characteristics.

6. Inrush Current

When power is first supplied to the IC, it is possible that the internal logic may be unstable and inrush current may flow instantaneously due to the internal powering sequence and delays, especially if the IC has more than one power supply. Therefore, give special consideration to power coupling capacitance, power wiring, width of ground wiring, and routing of connections.

7. Thermal Consideration

The power dissipation under actual operating conditions should be taken into consideration and a sufficient margin should be allowed in the thermal design. On the reverse side of the package this product has an exposed heat pad for improving the heat dissipation. The amount of heat generation depends on the voltage difference between the input and output, load current, and bias current. Therefore, when actually using the chip, ensure that the generated heat does not exceed the Pd rating. If Junction temperature is over Tjmax (= 150 °C), IC characteristics may be worse due to rising chip temperature. Heat resistance in specification is measurement under PCB condition and environment recommended in JEDEC. Ensure that heat resistance in specification is different from actual environment.

8. Testing on Application Boards

When testing the IC on an application board, connecting a capacitor directly to a low-impedance output pin may subject the IC to stress. Always discharge capacitors completely after each process or step. The IC's power supply should always be turned off completely before connecting or removing it from the test setup during the inspection process. To prevent damage from static discharge, ground the IC during assembly and use similar precautions during transport and storage.

9. Inter-pin Short and Mounting Errors

Ensure that the direction and position are correct when mounting the IC on the PCB. Incorrect mounting may result in damaging the IC. Avoid nearby pins being shorted to each other especially to ground, power supply and output pin. Inter-pin shorts could be due to many reasons such as metal particles, water droplets (in very humid environment) and unintentional solder bridge deposited in between pins during assembly to name a few.

10. Unused Input Pins

Input pins of an IC are often connected to the gate of a MOS transistor. The gate has extremely high impedance and extremely low capacitance. If left unconnected, the electric field from the outside can easily charge it. The small charge acquired in this way is enough to produce a significant effect on the conduction through the transistor and cause unexpected operation of the IC. So unless otherwise specified, unused input pins should be connected to the power supply or ground line.

Operational Notes – continued

11. Regarding the Input Pin of the IC

In the construction of this IC, P-N junctions are inevitably formed creating parasitic diodes or transistors. The operation of these parasitic elements can result in mutual interference among circuits, operational faults, or physical damage. Therefore, conditions which cause these parasitic elements to operate, such as applying a voltage to an input pin lower than the ground voltage should be avoided. Furthermore, do not apply a voltage to the input pins when no power supply voltage is applied to the IC. Even if the power supply voltage is applied, make sure that the input pins have voltages within the values specified in the electrical characteristics of this IC.

12. Ceramic Capacitor

When using a ceramic capacitor, determine a capacitance value considering the change of capacitance with temperature and the decrease in nominal capacitance due to DC bias and others.

13. Thermal Shutdown Protection Circuit (TSD)

This IC has a built-in thermal shutdown circuit that prevents heat damage to the IC. Normal operation should always be within the IC's maximum junction temperature rating. If however the rating is exceeded for a continued period, the junction temperature (T_j) will rise which will activate the TSD circuit that will turn OFF power output pins. When the T_j falls below the TSD threshold, the circuits are automatically restored to normal operation.

Note that the TSD circuit operates in a situation that exceeds the absolute maximum ratings and therefore, under no circumstances, should the TSD circuit be used in a set design or for any purpose other than protecting the IC from heat damage.

14. Over Current Protection Circuit (OCP)

This IC incorporates an integrated overcurrent protection circuit that is activated when the load is shorted. This protection circuit is effective in preventing damage due to sudden and unexpected incidents. However, the IC should not be used in applications characterized by continuous operation or transitioning of the protection circuit.

15. Enable Pin

The EN pin is for controlling ON/OFF the output voltage. Do not make voltage level of chip enable keep floating level, or between V_{ENH} and V_{ENL} . Otherwise, the output voltage would be unstable or indefinite.

Marking Diagram

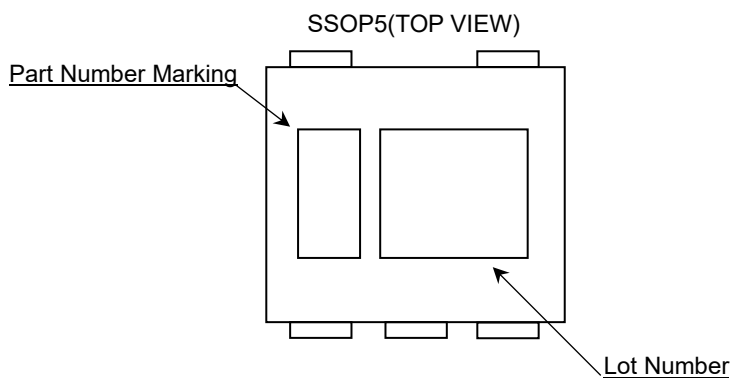

Part Number	Output Voltage [V]	Part Number Marking
BU12JA3DG-CTR BU12JA3DG-CTL	1.2	ar
BU15JA3DG-CTR BU15JA3DG-CTL	1.5	au
BU18JA3DG-CTR BU18JA3DG-CTL	1.8	ay
BU25JA3DG-CTR BU25JA3DG-CTL	2.5	ba
BU30JA3DG-CTR BU30JA3DG-CTL	3.0	bb
BU33JA3DG-CTR BU33JA3DG-CTL	3.3	bd

Physical Dimension and Packing Information

Package Name	SSOP5
--------------	-------

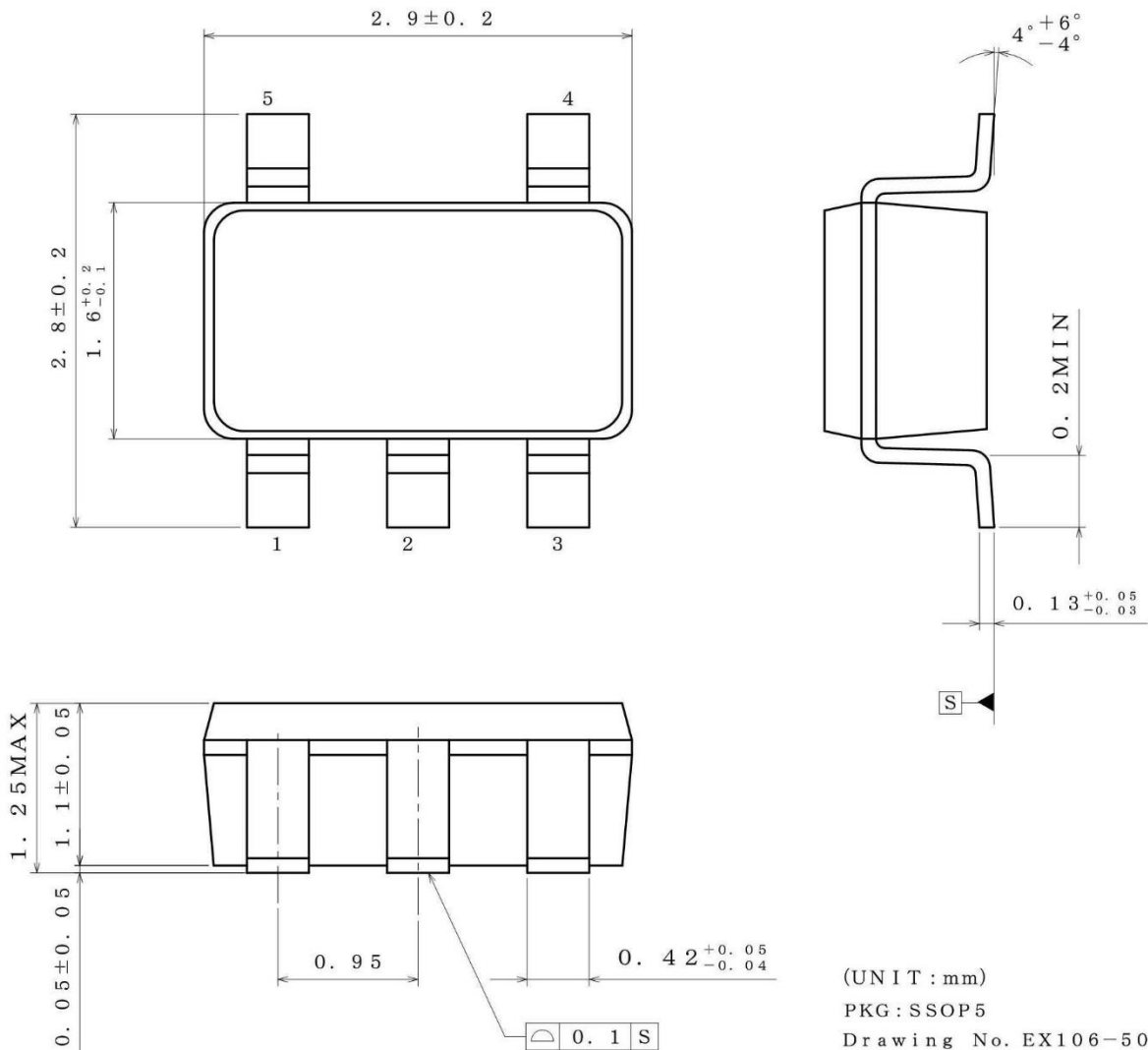

< Tape and Reel Information >

Tape	Embossed carrier tape
Quantity	3000pcs
Direction of feed	TR (The direction is the 1pin of product is at the upper right when you hold reel on the left hand and you pull out the tape on the right hand)

< Tape and Reel Information >

Tape	Embossed carrier tape
Quantity	3000pcs
Direction of feed	TL (The direction is the 1pin of product is at the lower left when you hold reel on the left hand and you pull out the tape on the right hand)

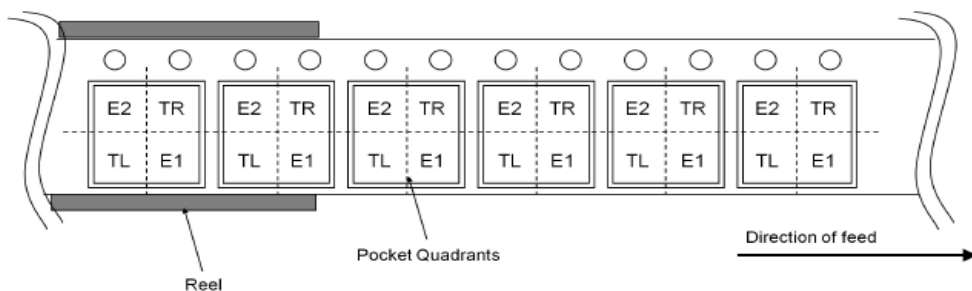

Revision History

Date	Revision	Changes
15.Nov.2021	001	New Release
27.Jun.2022	002	Add Typical Performance data

Notice

Precaution on using ROHM Products

1. If you intend to use our Products in devices requiring extremely high reliability (such as medical equipment ^(Note 1), aircraft/spacecraft, nuclear power controllers, etc.) and whose malfunction or failure may cause loss of human life, bodily injury or serious damage to property ("Specific Applications"), please consult with the ROHM sales representative in advance. Unless otherwise agreed in writing by ROHM in advance, ROHM shall not be in any way responsible or liable for any damages, expenses or losses incurred by you or third parties arising from the use of any ROHM's Products for Specific Applications.

(Note1) Medical Equipment Classification of the Specific Applications

JAPAN	USA	EU	CHINA
CLASS III	CLASS III	CLASS II b	CLASS III
CLASS IV		CLASS III	

2. ROHM designs and manufactures its Products subject to strict quality control system. However, semiconductor products can fail or malfunction at a certain rate. Please be sure to implement, at your own responsibilities, adequate safety measures including but not limited to fail-safe design against the physical injury, damage to any property, which a failure or malfunction of our Products may cause. The following are examples of safety measures:
 - [a] Installation of protection circuits or other protective devices to improve system safety
 - [b] Installation of redundant circuits to reduce the impact of single or multiple circuit failure
3. Our Products are not designed under any special or extraordinary environments or conditions, as exemplified below. Accordingly, ROHM shall not be in any way responsible or liable for any damages, expenses or losses arising from the use of any ROHM's Products under any special or extraordinary environments or conditions. If you intend to use our Products under any special or extraordinary environments or conditions (as exemplified below), your independent verification and confirmation of product performance, reliability, etc. prior to use, must be necessary:
 - [a] Use of our Products in any types of liquid, including water, oils, chemicals, and organic solvents
 - [b] Use of our Products outdoors or in places where the Products are exposed to direct sunlight or dust
 - [c] Use of our Products in places where the Products are exposed to sea wind or corrosive gases, including Cl₂, H₂S, NH₃, SO₂, and NO₂
 - [d] Use of our Products in places where the Products are exposed to static electricity or electromagnetic waves
 - [e] Use of our Products in proximity to heat-producing components, plastic cords, or other flammable items
 - [f] Sealing or coating our Products with resin or other coating materials
 - [g] Use of our Products without cleaning residue of flux (Exclude cases where no-clean type fluxes is used. However, recommend sufficiently about the residue.); or Washing our Products by using water or water-soluble cleaning agents for cleaning residue after soldering
 - [h] Use of the Products in places subject to dew condensation
4. The Products are not subject to radiation-proof design.
5. Please verify and confirm characteristics of the final or mounted products in using the Products.
6. In particular, if a transient load (a large amount of load applied in a short period of time, such as pulse, is applied, confirmation of performance characteristics after on-board mounting is strongly recommended. Avoid applying power exceeding normal rated power; exceeding the power rating under steady-state loading condition may negatively affect product performance and reliability.
7. De-rate Power Dissipation depending on ambient temperature. When used in sealed area, confirm that it is the use in the range that does not exceed the maximum junction temperature.
8. Confirm that operation temperature is within the specified range described in the product specification.
9. ROHM shall not be in any way responsible or liable for failure induced under deviant condition from what is defined in this document.

Precaution for Mounting / Circuit board design

1. When a highly active halogenous (chlorine, bromine, etc.) flux is used, the residue of flux may negatively affect product performance and reliability.
2. In principle, the reflow soldering method must be used on a surface-mount products, the flow soldering method must be used on a through hole mount products. If the flow soldering method is preferred on a surface-mount products, please consult with the ROHM representative in advance.

For details, please refer to ROHM Mounting specification

Precautions Regarding Application Examples and External Circuits

1. If change is made to the constant of an external circuit, please allow a sufficient margin considering variations of the characteristics of the Products and external components, including transient characteristics, as well as static characteristics.
2. You agree that application notes, reference designs, and associated data and information contained in this document are presented only as guidance for Products use. Therefore, in case you use such information, you are solely responsible for it and you must exercise your own independent verification and judgment in the use of such information contained in this document. ROHM shall not be in any way responsible or liable for any damages, expenses or losses incurred by you or third parties arising from the use of such information.

Precaution for Electrostatic

This Product is electrostatic sensitive product, which may be damaged due to electrostatic discharge. Please take proper caution in your manufacturing process and storage so that voltage exceeding the Products maximum rating will not be applied to Products. Please take special care under dry condition (e.g. Grounding of human body / equipment / solder iron, isolation from charged objects, setting of Ionizer, friction prevention and temperature / humidity control).

Precaution for Storage / Transportation

1. Product performance and soldered connections may deteriorate if the Products are stored in the places where:
 - [a] the Products are exposed to sea winds or corrosive gases, including Cl₂, H₂S, NH₃, SO₂, and NO₂
 - [b] the temperature or humidity exceeds those recommended by ROHM
 - [c] the Products are exposed to direct sunshine or condensation
 - [d] the Products are exposed to high Electrostatic
2. Even under ROHM recommended storage condition, solderability of products out of recommended storage time period may be degraded. It is strongly recommended to confirm solderability before using Products of which storage time is exceeding the recommended storage time period.
3. Store / transport cartons in the correct direction, which is indicated on a carton with a symbol. Otherwise bent leads may occur due to excessive stress applied when dropping of a carton.
4. Use Products within the specified time after opening a humidity barrier bag. Baking is required before using Products of which storage time is exceeding the recommended storage time period.

Precaution for Product Label

A two-dimensional barcode printed on ROHM Products label is for ROHM's internal use only.

Precaution for Disposition

When disposing Products please dispose them properly using an authorized industry waste company.

Precaution for Foreign Exchange and Foreign Trade act

Since concerned goods might be fallen under listed items of export control prescribed by Foreign exchange and Foreign trade act, please consult with ROHM in case of export.

Precaution Regarding Intellectual Property Rights

1. All information and data including but not limited to application example contained in this document is for reference only. ROHM does not warrant that foregoing information or data will not infringe any intellectual property rights or any other rights of any third party regarding such information or data.
2. ROHM shall not have any obligations where the claims, actions or demands arising from the combination of the Products with other articles such as components, circuits, systems or external equipment (including software).
3. No license, expressly or implied, is granted hereby under any intellectual property rights or other rights of ROHM or any third parties with respect to the Products or the information contained in this document. Provided, however, that ROHM will not assert its intellectual property rights or other rights against you or your customers to the extent necessary to manufacture or sell products containing the Products, subject to the terms and conditions herein.

Other Precaution

1. This document may not be reprinted or reproduced, in whole or in part, without prior written consent of ROHM.
2. The Products may not be disassembled, converted, modified, reproduced or otherwise changed without prior written consent of ROHM.
3. In no event shall you use in any way whatsoever the Products and the related technical information contained in the Products or this document for any military purposes, including but not limited to, the development of mass-destruction weapons.
4. The proper names of companies or products described in this document are trademarks or registered trademarks of ROHM, its affiliated companies or third parties.

General Precaution

1. Before you use our Products, you are requested to carefully read this document and fully understand its contents. ROHM shall not be in any way responsible or liable for failure, malfunction or accident arising from the use of any ROHM's Products against warning, caution or note contained in this document.
2. All information contained in this document is current as of the issuing date and subject to change without any prior notice. Before purchasing or using ROHM's Products, please confirm the latest information with a ROHM sales representative.
3. The information contained in this document is provided on an "as is" basis and ROHM does not warrant that all information contained in this document is accurate and/or error-free. ROHM shall not be in any way responsible or liable for any damages, expenses or losses incurred by you or third parties resulting from inaccuracy or errors of or concerning such information.