



RIGOL

DSG5000 Series

Microwave Signal Generator

DataSheet

DSG04100-1110

Jun.2022

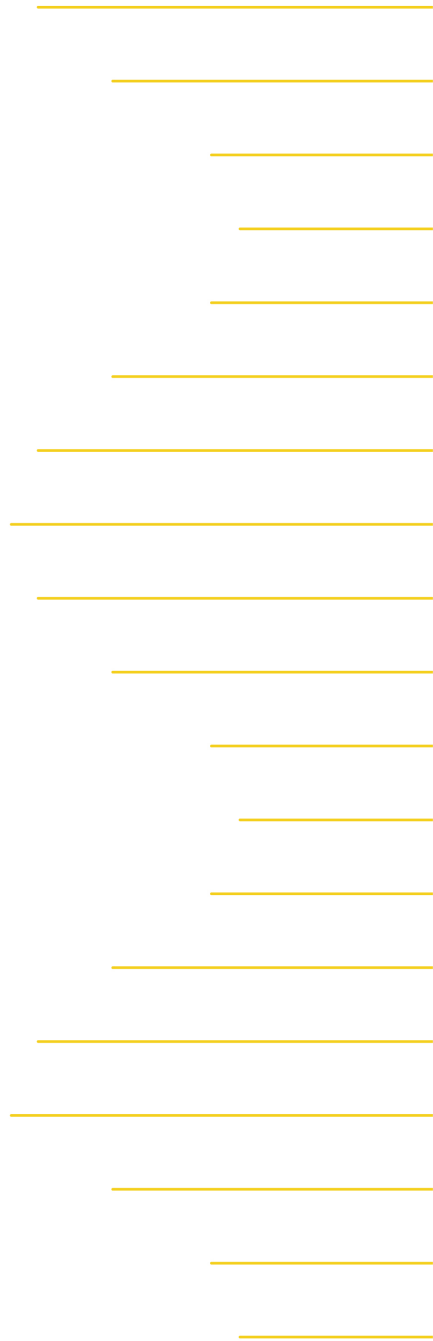

DSG5000 Series

Microwave Signal Generator



Highlights

- Multi-channel with up to 8 channels, support multi-device rack mount
- Channel-to-channel phase stability $< 1^\circ @ 10\text{GHz}$, resolution of phase offset setting adjustable in 0.01° steps
- Fast switching speed 3 ms
- Output max. available power up to 25 dBm
- Low phase noise below $-133 \text{ dBc/Hz} @ 1 \text{ GHz}$, 10 kHz offset

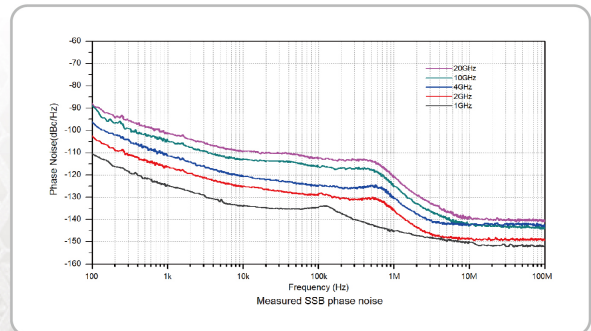
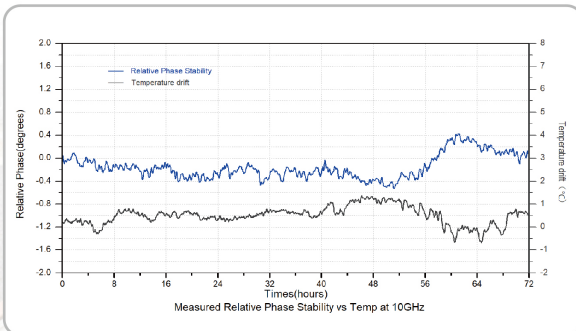

Superb Long-term Phase Stability and Low Phase Noise

RF 50Ω

RF 50Ω

RF 50Ω

RF 50Ω



DSG5000 series microwave signal generator can generate high quality signals, accurate signal level and wide output power range, capable of meeting the complex test scenarios such as superconducting quantum computation, radar signal generation, MIMO, and EMS.

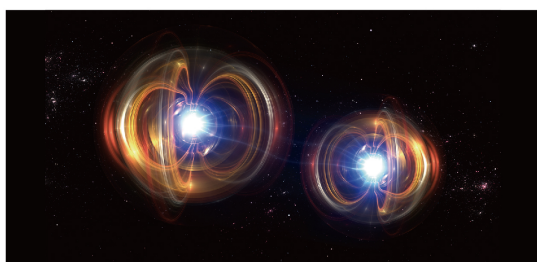

Superconducting Quantum Computation



MIMO



Radar Signal Generation

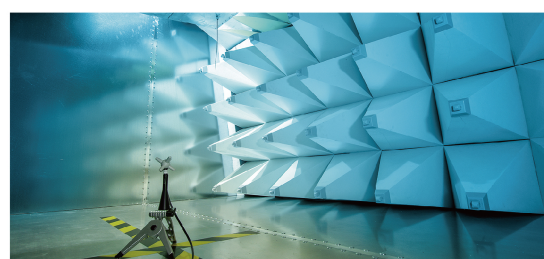

EMS



Technical Advantage

High Performance

- Excellent channel-to-channel phase stability, low phase noise, and high power output
- AM, FM, PM, and pulse modulation (Opt.); pulse train generator enables users to generate the user-defined pulse list
- Frequency sweep, level sweep, and Freq & Level sweep (Std.); list sweep mode enables users to generate the user-defined sweep list

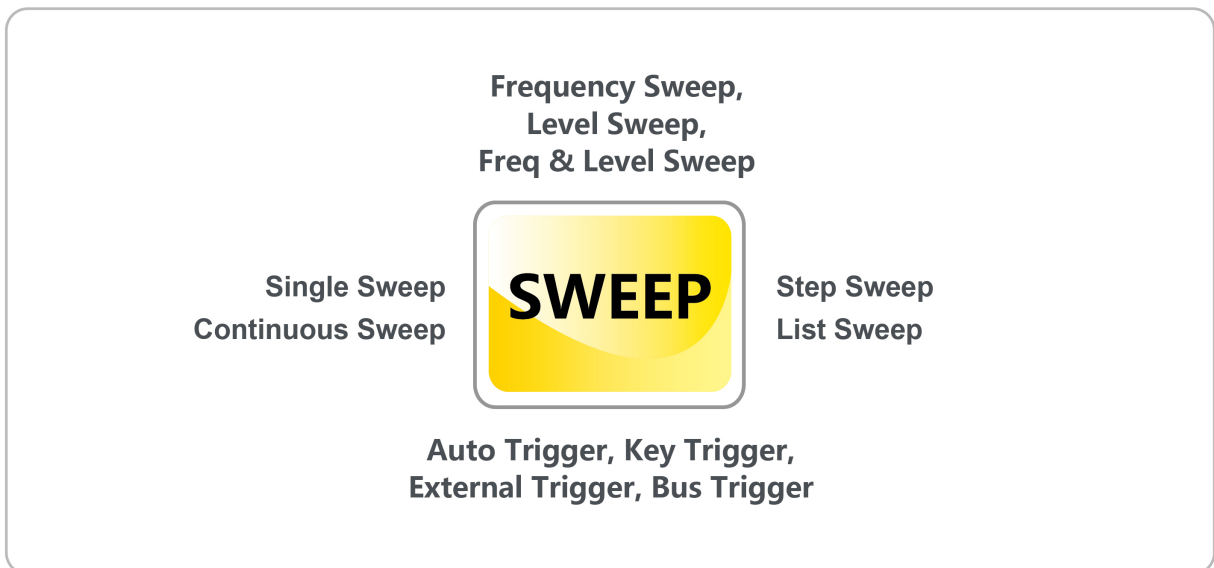
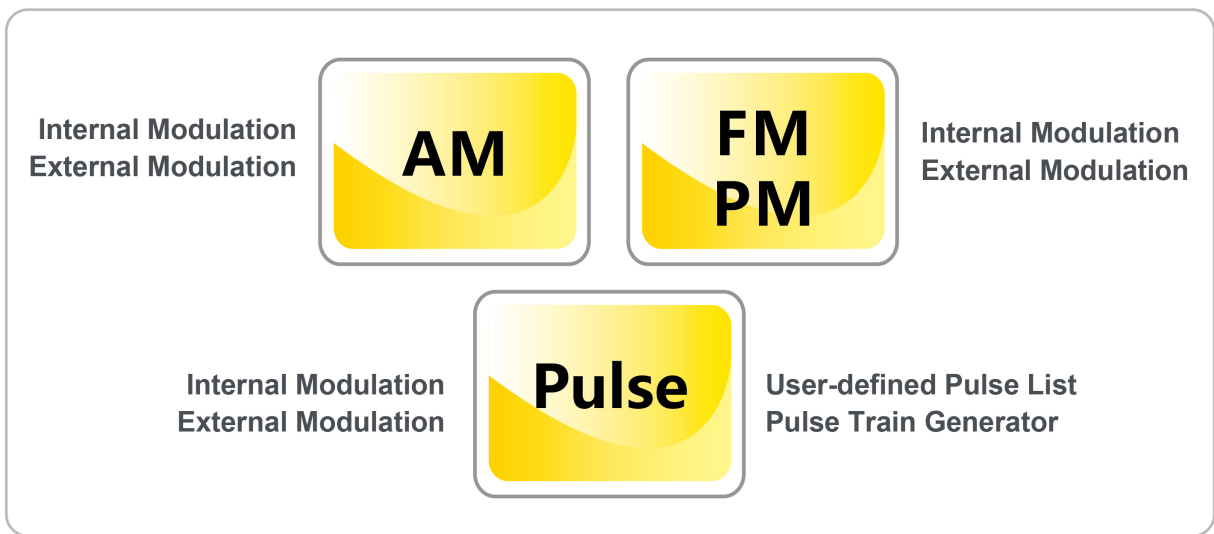

Compact Design

The instrument model supports up to 8 channels, with each channel independent of each other and independently controlled. Multiple devices can be integrated in rack mount installation, saving space and time.



High Expansion

- With a standard 2U rack size and rack mount kit, you can extend the channels of the DSG5000 series microwave signal generator.
- The front and rear-panel ventilation design provides adequate ventilation to ensure the signal accuracy and stability even if multiple devices are stacked in the cabinet.
- The DSG5000 series is equipped with a standard configuration of the PC software to realize integrated control of multiple instruments. With the PC software, you can operate the instrument in remote control and make a global parameter configuration for multiple channels to meet the integrated test application scenarios.



User-friendly Operation

The DSG5000 series microwave signal generator is equipped with the touch screen. It also allows you to connect an external display to operate the instrument. You can also use the Web Control software to realize remote control of the instrument or use the SCPI commands to control the instrument.

Self-equipped Touch Screen

The DSG5000 series is equipped with a touch screen, which enables you to operate and control the instrument with touch-enabled gestures. It does not have any physical keys on the front panel to operate except the power key.

Externally Connected Display

The DSG5000 series allows you to externally connect the display (e.g. PAD, monitor, and projector) via the HDMI interface to enjoy user-friendly operation and viewing experience with a greater choice of the display devices.

Web Control Remote Operation

You only need to input the IP address of the DSG5000 series into the address bar of the Web browser to open the Web Control software.

The display of the current user interface shown in the web control page is consistent with that in the DSG5000 series. You can use the mouse to click the menus in the Web Control interface to operate the instrument in remote control way. In the Web Control interface, you can click to view the basic information of the instrument, and you can also set or modify the network status.

Control with the SCPI Command Set

The DSG5000 series supports the standard SCPI command set. You can send the SCPI commands via the USB or LAN interface to realize remote control of the instrument. Moreover, you can use the Excel, LabVIEW, Visual Basic, Visual C++, and relevant programming tools to send commands in batches automatically, to meet the demands of automation test scenarios.



Product Appearance

DSG5000 Series

Microwave Signal Generator

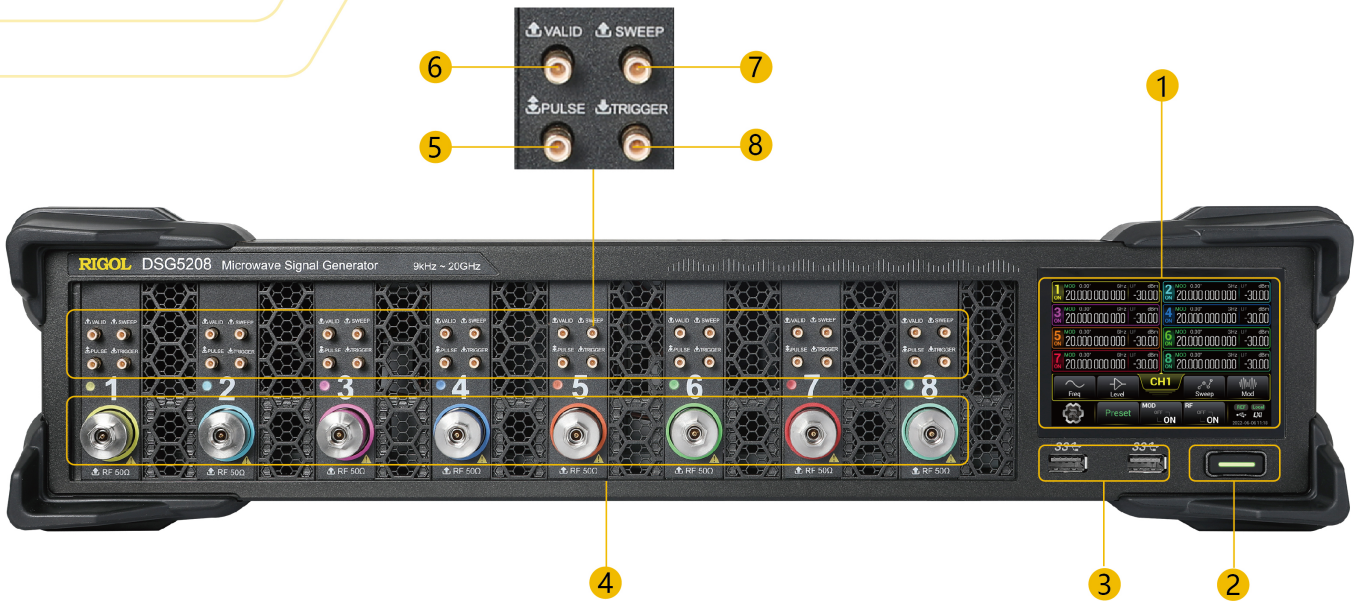

| No. | Description | No. | Description |
|-----|----------------------------|-----|-------------------------------------|
| 1 | Touch Screen | 5 | Pulse Signal Input/Output Connector |
| 2 | Power Key | 6 | Valid Signal Output Connector |
| 3 | USB HOST Interface | 7 | Sweep Output Connector |
| 4 | RF Signal Output Connector | 8 | External Trigger Input Connector |

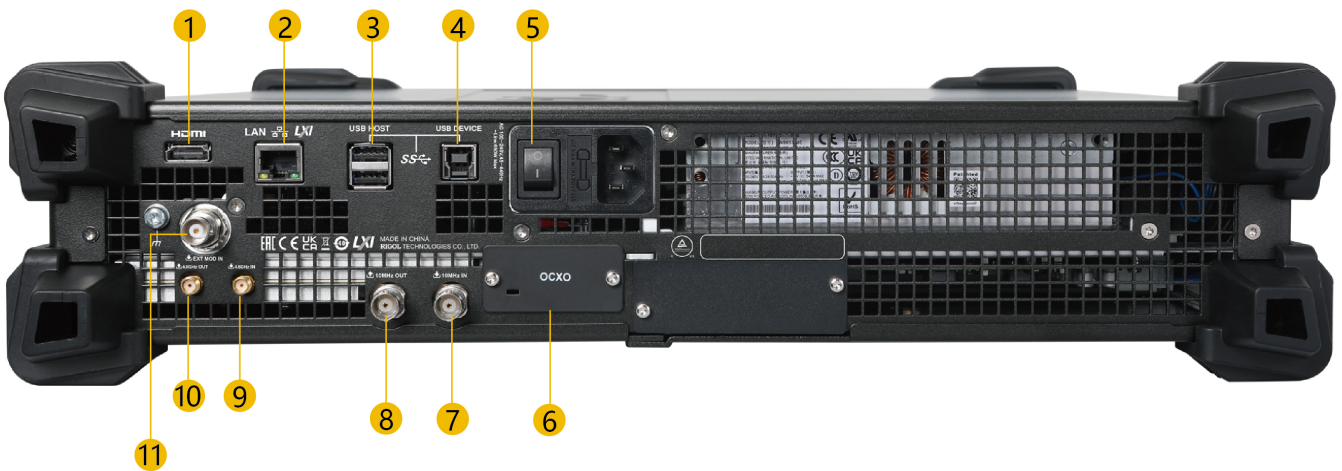

| No. | Description | No. | Description |
|-----|-----------------------------|-----|-------------|
| 1 | HDMI Interface | 7 | 10MHz IN |
| 2 | LAN Interface | 8 | 10MHz OUT |
| 3 | USB HOST Interface | 9 | 4.8GHz IN |
| 4 | USB DEVICE Interface | 10 | 4.8GHz OUT |
| 5 | Power Switch | 11 | EXT MOD IN |
| 6 | High Stability Clock (OCXO) | | |

Specifications

Specifications are valid under the following conditions: the instrument is within the calibration period; stored for at least two hours at 0°C to 50°C temperature; 40-minute warm-up. Unless otherwise noted, the specifications in the manual include the measurement uncertainty.

- **Typical (typ.):** typical performance, which 80 percent of the measurement results will meet at room temperature (approximately 25°C). The data are not warranted and do not include the measurement uncertainty.
- **Nominal (nom.):** the expected mean or average performance or a designed attribute (such as the 50Ω connector). The data are not warranted and are measured at room temperature (approximately 25°C).
- **Measured (meas.):** an attribute measured during the design phase which can be compared to the expected performance, i.g. the amplitude drift varies with time. The data are not warranted and are measured at room temperature (approximately 25°C).

Note: All charts in this manual are the measurement results of multiple instruments at room temperature unless otherwise noted.

Number of Channels

| Number of Channels | | | | |
|--------------------|---------|---------|---------|---------|
| Model | DSG5122 | DSG5124 | DSG5126 | DSG5128 |
| | DSG5202 | DSG5204 | DSG5206 | DSG5208 |
| Number of Channels | 2 | 4 | 6 | 8 |

Frequency

| Frequency | |
|-----------------------------|---|
| Frequency Range | DSG5122/DSG5124/DSG5126/ DSG5128 |
| | DSG5202/DSG5204/DSG5206/ DSG5208 |
| | 9 kHz to 12 GHz |
| Frequency Resolution | 0.01 Hz |
| Setting Time ^[1] | CW mode, temperature range 20°C to 30°C |
| | <3 ms (typ.) |

Note:[1] Time from receipt of SCPI command to within 0.1 ppm of final frequency.

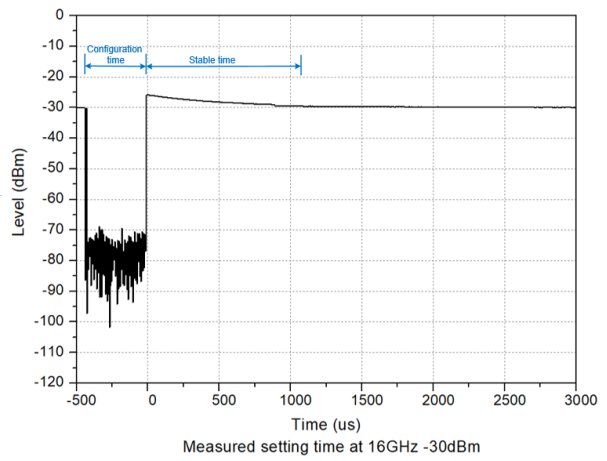
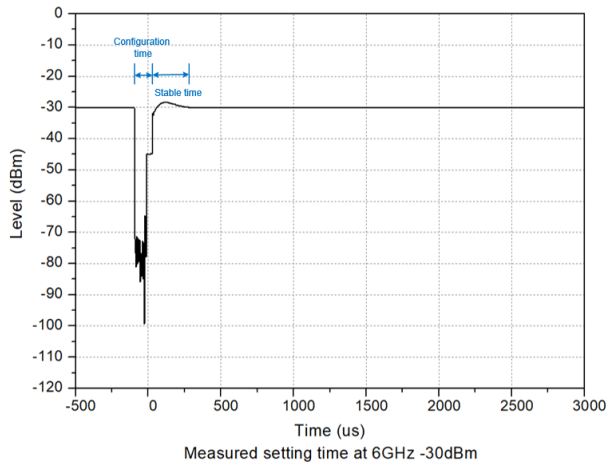

Frequency Band

| Band | Frequency Range | N ^[1] |
|------|--------------------------|------------------|
| 1 | 9 kHz ≤ f ≤ 1.5 GHz | 1 |
| 2 | 1.5 GHz < f ≤ 2.825 GHz | 0.25 |
| 3 | 2.825 GHz < f ≤ 5.65 GHz | 0.5 |
| 4 | 5.65 GHz < f ≤ 11.3 GHz | 1 |
| 5 | 11.3 GHz < f ≤ 20 GHz | 2 |

Note:[1] N is a factor used to help define certain specifications in this manual.

Channel-to-Channel Phase Stability

| | f = 10 GHz, temperature variation ≤ 1°C |
|------------------------------------|---|
| Channel-to-Channel Phase Stability | ± 1° |

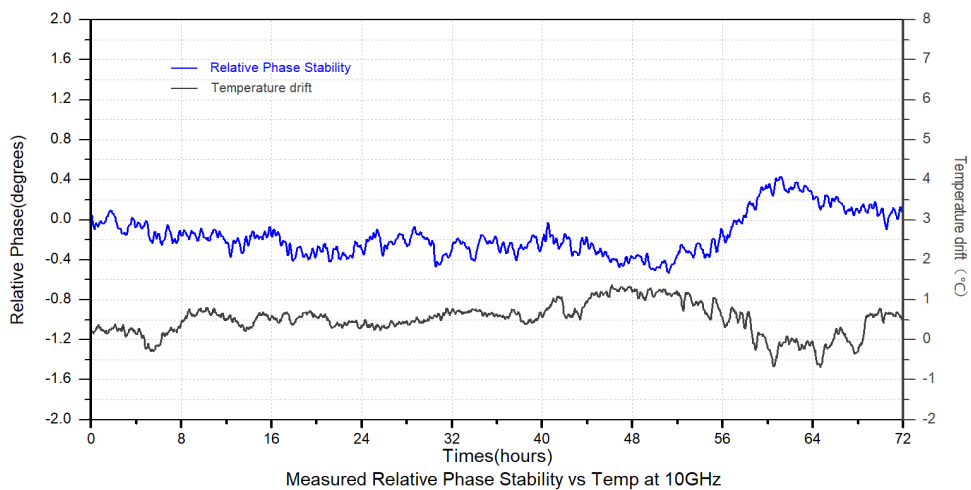

Frequency Reference

| | | |
|---------------------------------|---|--|
| Clock Reference Output | Frequency | 10 MHz |
| | Initial Calibration Accuracy | ± 0.1 ppm |
| | | ± 10 ppb (with option OCXO-D08) |
| | Temperature Stability, temperature range 0°C to 50°C, reference to 25°C | ± 0.5 ppm |
| | | ± 5 ppb (with option OCXO-D08) |
| | Aging Rate (after 30 consecutive days of working) | ± 1 ppm/year |
| | | ± 30 ppb/year (with option OCXO-D08) |
| Output Amplitude | +5 dBm to +10 dBm | |
| Interface | BNC female | |
| External Reference Input | Frequency | 10 MHz |
| | Input Amplitude | 0 dBm to +10 dBm |
| | Max. Deviation | ± 1 ppm |
| | Interface | BNC female |
| Sync Ref Frequency Output/Input | Freq | 4.8 GHz |
| | Amplitude | -3 dBm to +3 dBm |
| | Interface | SMA female |

Phase Setting

| | |
|----------------------------|-----------------|
| Phase Deviation Range | $\pm 180^\circ$ |
| Phase Deviation Resolution | 0.01° |

Spectral Purity

| | | | |
|-----------------------------|--|---------------------------|----------|
| Harmonic ^[1] | CW mode | | |
| | 10 MHz ≤ f ≤ 4 GHz | output level ≤ +10 dBm | <-30 dBc |
| | 4 GHz < f ≤ 10 GHz | output level ≤ +10 dBm | <-50 dBc |
| | 10 GHz < f ≤ 20 GHz | output level ≤ +7 dBm | <-30 dBc |
| Sub-harmonic | CW mode | | |
| | 11.3 GHz < f ≤ 20 GHz | <-60 dBm, <-70 dBc (typ.) | |
| Non-harmonic ^[2] | CW mode, output level > -10 dBm, carrier offset > 10 kHz | | |
| | 1 MHz ≤ f ≤ 1.5 GHz | <-60 dBm, <-70 dBc (typ.) | |
| | 1.5 GHz < f ≤ 2.825 GHz | <-70 dBm, <-75 dBc (typ.) | |
| | 2.825 GHz < f ≤ 5.65 GHz | <-64 dBm, <-69 dBc (typ.) | |
| | 5.65 GHz < f ≤ 11.3 GHz | <-58 dBm, <-63 dBc (typ.) | |
| | 11.3 GHz < f ≤ 20 GHz | <-52 dBm, <-57 dBc (typ.) | |

Note:

[1] Applicable when the analog modulation is disabled.

[2] Exclude the frequency points related to 4800 MHz reference clock.

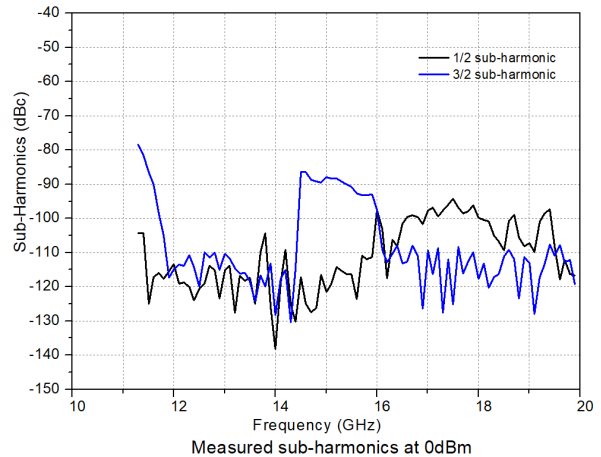
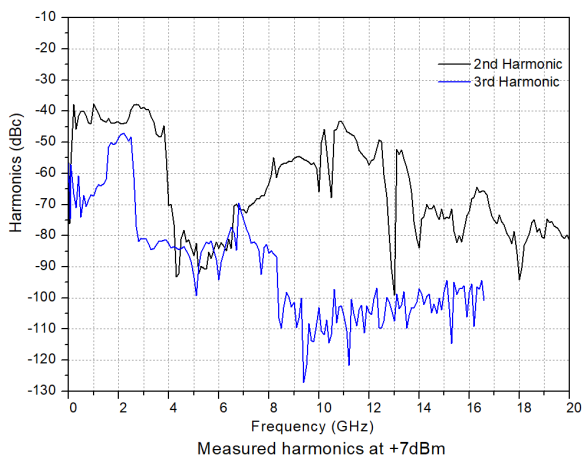

Sideband Noise

| | | |
|--------------------------------|---|-------------------------------------|
| | CW mode, carrier offset = 10 kHz, 1 Hz measurement bandwidth | |
| SSB Phase Noise ^[1] | f = 1 GHz | < -130 dBc/Hz, < -133 dBc/Hz (typ.) |
| | f = 2 GHz | < -120 dBc/Hz, < -123 dBc/Hz (typ.) |
| | f = 4 GHz | < -114 dBc/Hz, < -117 dBc/Hz (typ.) |
| | f = 10 GHz | < -108 dBc/Hz, < -111 dBc/Hz (typ.) |
| | f = 20 GHz | < -102 dBc/Hz, < -105 dBc/Hz (typ.) |
| | CW mode, amplitude +10 dBm, carrier offset = 10 MHz, 1 Hz measurement bandwidth | |
| Wideband Noise | 50 MHz ≤ f ≤ 1 GHz | < -140 dBc/Hz |
| | 1 GHz < f ≤ 10 GHz | < -135 dBc/Hz |
| | 10 GHz < f ≤ 20 GHz | < -130 dBc/Hz |

Note:[1] Applicable when the analog modulation is disabled.

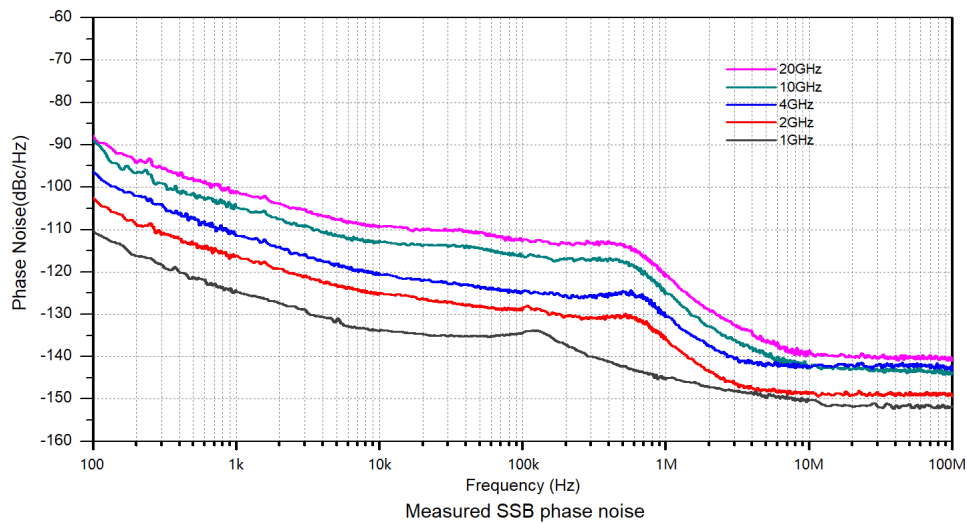

Amplitude

Output Level Setting Range

| Frequency | Minimum Output Specification Level | Minimum Output Setting Level | Maximum Output Specification Level | Maximum Output Setting Level |
|--|------------------------------------|------------------------------|------------------------------------|------------------------------|
| $9 \text{ kHz} \leq f < 100 \text{ kHz}$ | - | -30 dBm | - | +10 dBm |
| $100 \text{ kHz} \leq f < 2 \text{ MHz}$ | -30 dBm | -30 dBm | +5 dBm | +15 dBm |
| $2 \text{ MHz} \leq f \leq 10 \text{ GHz}$ | -30 dBm | -30 dBm | +13 dBm | +25 dBm |
| $10 \text{ GHz} < f \leq 17 \text{ GHz}$ | -30 dBm | -30 dBm | +13 dBm | +20 dBm |
| $17 \text{ GHz} < f \leq 20 \text{ GHz}$ | -30 dBm | -30 dBm | +10 dBm | +20 dBm |

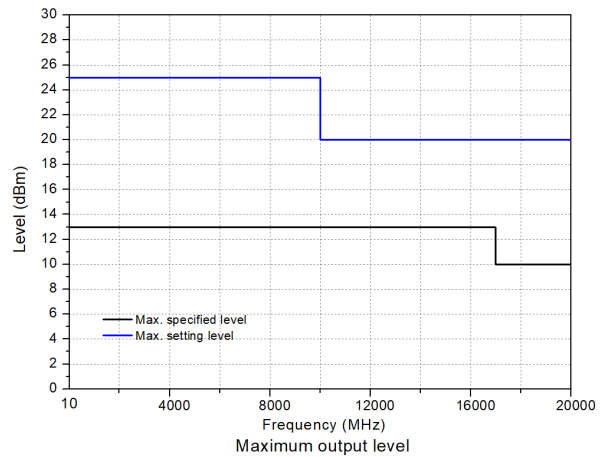
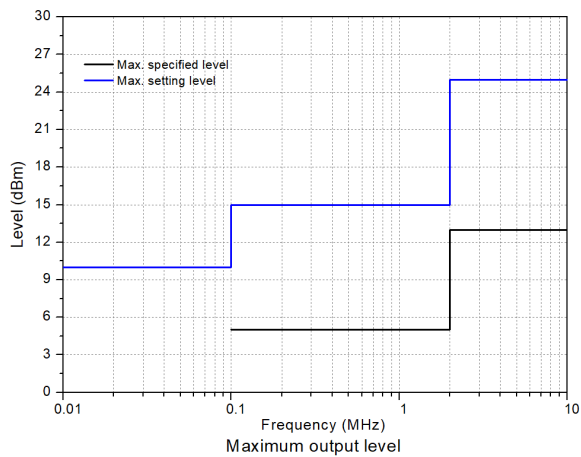

Setting Resolution

| | |
|--------------------|---------|
| Setting Resolution | 0.01 dB |
|--------------------|---------|

Setting Time

| | |
|-----------------------------|--|
| Setting Time ^[1] | CW mode, temperature range 20°C to 30°C, fixed frequency |
| | <3 ms (typ.) |

Note:[1] Time from receipt of SCPI command to within 0.1 dB of final level.

Absolute Level Uncertainty

| | Temperature range 20°C to 30°C, output level -30 dBm to max. specification level | |
|-----------------------|--|----------|
| Frequency | Specification | Typical |
| 100 kHz ≤ f ≤ 1.5 GHz | ±0.7 dB | ± 0.5 dB |
| 1.5 GHz < f ≤ 10 GHz | ±0.9 dB | ±0.7 dB |
| 10 GHz < f ≤ 17 GHz | ±1.1 dB | ±0.9 dB |
| 17 GHz < f ≤ 20 GHz | ±1.3 dB | ±1.1 dB |

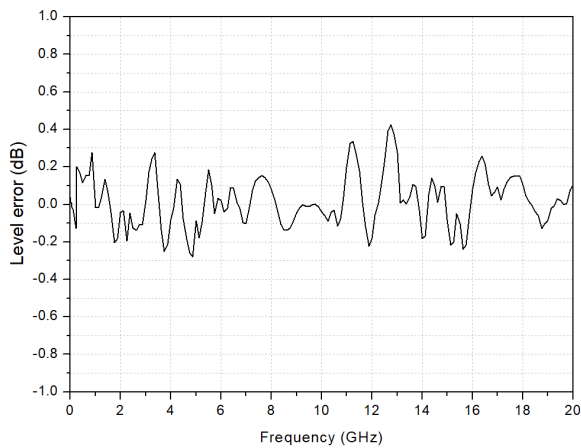

Measured at +10dBm, level error vs frequency

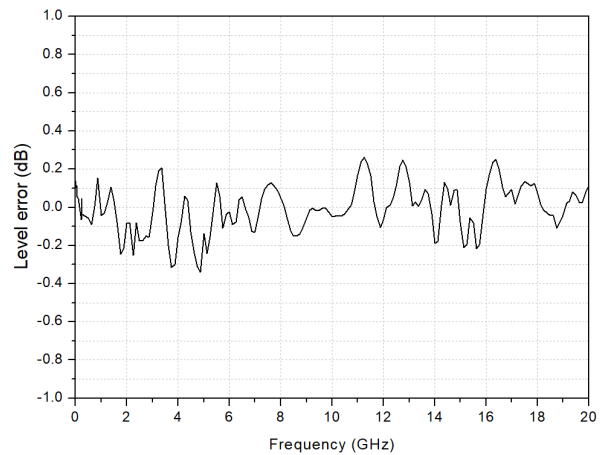

Measured at -30dBm, level error vs frequency

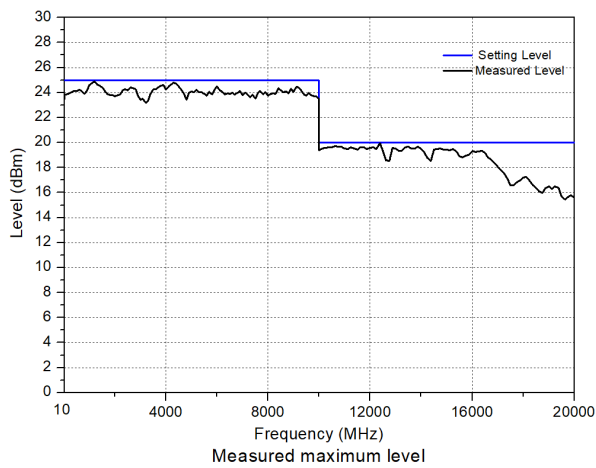

Measured maximum level

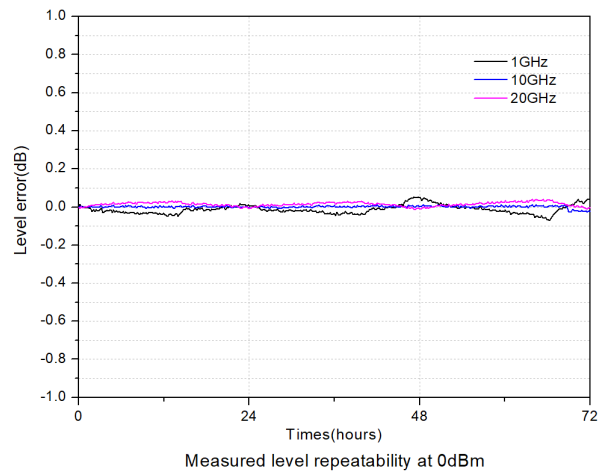

Measured level repeatability at 0dBm

Channel-to-Channel Isolation

| Frequency | channel-to-channel isolation, output level= 0 dBm |
|--|---|
| $9 \text{ kHz} \leq f < 4 \text{ GHz}$ | >85 dB (typ.) |
| $4 \text{ GHz} \leq f \leq 10 \text{ GHz}$ | >80 dB (typ.) |
| $10 \text{ GHz} < f \leq 20 \text{ GHz}$ | >75 dB (typ.) |

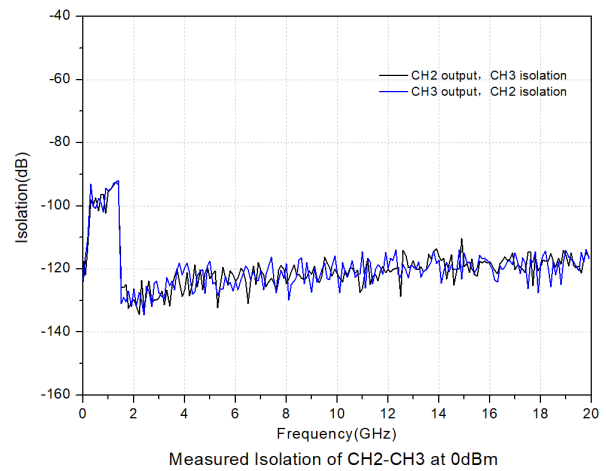
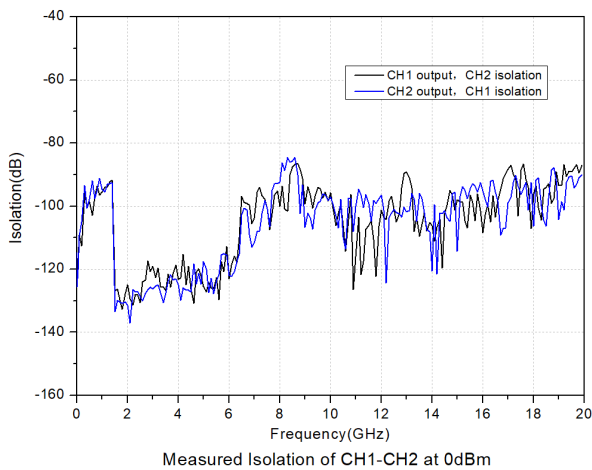

VSWR

| | Temperature range 20°C to 30°C, output level < 0 dBm |
|--|--|
| $10 \text{ MHz} \leq f \leq 3 \text{ GHz}$ | ≤ 1.8 (nom.) |
| $3 \text{ GHz} < f \leq 6 \text{ GHz}$ | ≤ 2.0 (nom.) |
| $6 \text{ GHz} < f \leq 10 \text{ GHz}$ | ≤ 1.8 (nom.) |
| $10 \text{ GHz} < f \leq 20 \text{ GHz}$ | ≤ 2.2 (nom.) |

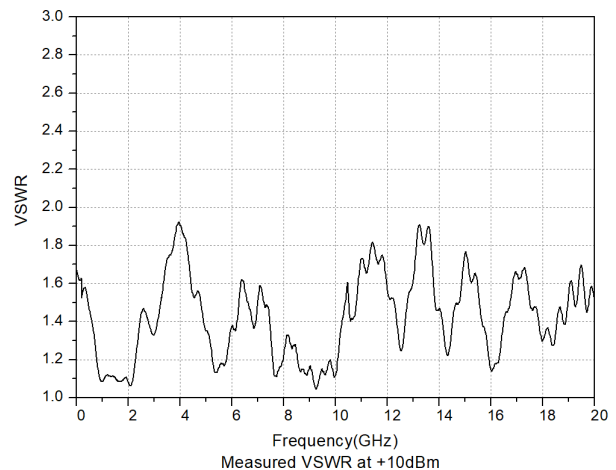
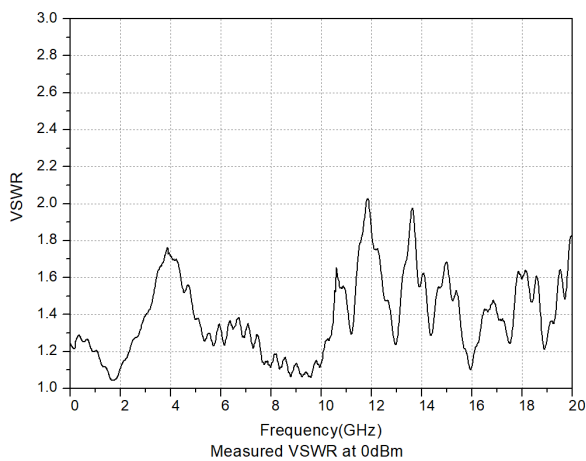

| Max. Reverse Power | | |
|--------------------|---------------------|-------|
| Max. Reverse Power | Max. DC voltage | 0V |
| | 10 MHz < f ≤ 20 GHz | 0.5 W |

Sweep^[1]

| Frequency Sweep | |
|-----------------------------|--|
| Sweep Type | Step Sweep, List Sweep |
| Sweep Mode | Single, Continuous |
| Sweep Range | Within Full Frequency Range |
| Sweep Shape | Triangle and Ramp |
| Step Change | Linear or Log |
| Sweep Points ^[2] | 2 to 1,001 |
| Dwell Time | 5 ms to 100 s |
| Trigger Type ^[3] | Auto, key, external, bus (USB and LAN) |

Note:

[1] To optimize the sweep performance, you may find that when the dwell time is short, the displayed sweep state may not be synchronously updated with the output.

[2] Applicable to step sweep and list sweep.

[3] In external trigger, the trigger delay time is equal to the setting time.

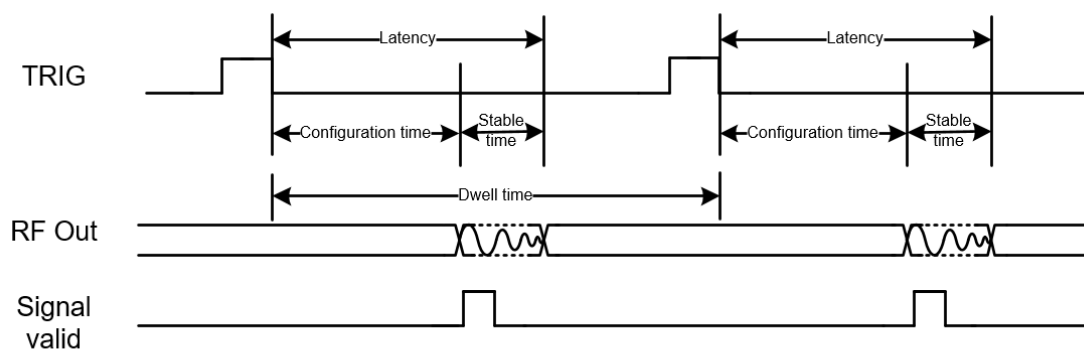

Time Definitions Triggered Pulse

Level Sweep

| | |
|-----------------------------|--|
| Sweep Type | Step Sweep, List Sweep |
| Sweep Mode | Single, Continuous |
| Sweep Range | Within Full Level Range |
| Sweep Shape | Triangle and Ramp |
| Step Change | Lin |
| Sweep Points ^[1] | 2 to 1,001 |
| Dwell Time | 5 ms to 100 s |
| Trigger Type | Auto, key, external, bus (USB and LAN) |

Note:[1] Applicable to step sweep and list sweep.

Modulation^[1]

Simultaneous Modulation

| | Amplitude Modulation | Frequency Modulation | Phase Modulation | Pulse Modulation |
|----------------------|----------------------|----------------------|------------------|------------------|
| Amplitude Modulation | - | ○ | ○ | △ |
| Frequency Modulation | ○ | - | × | ○ |
| Phase Modulation | ○ | × | - | ○ |
| Pulse Modulation | △ | ○ | ○ | - |

NOTE:

○:compatible; ×: incompatible; △: compatible with AM performance reduced when pulse modulation is enabled

Note:[1] Unless otherwise specified, the specifications are applicable to the situation when the modulation source is Sine. Temperature range 20°C to 30°C, carrier frequency ≥ 1 MHz.

Amplitude Modulation (Option DSG5000-AMD)

| | |
|---------------------------------|--|
| Modulation Source | Internal, External |
| Modulation Depth ^[1] | 0% to 100% |
| Resolution | 0.1% |
| Setting Uncertainty | $f_c \leq 1.5 \text{ GHz}$, $f_{\text{mod}} = 1 \text{ kHz}$, $m < 30\%$, level = 0 dBm |
| | < 4% of setting + 1% |
| Distortion | $f_c \leq 1.5 \text{ GHz}$, $f_{\text{mod}} = 1 \text{ kHz}$, $m < 30\%$, level = 0 dBm |
| | < 3% (typ.) |
| Modulation Frequency Response | $m < 80\%$, DC/10 Hz to 100 kHz |
| | <3 dB (nom.) |

Note:[1] The envelop peak power shall not be greater than the maximum value of the specification output range.

Frequency Modulation (Option DSG5000-AMD)

| | |
|--|--|
| Modulation Source | Internal, External |
| Max. Deviation ^[1] | $f \leq 1.5 \text{ GHz}$ |
| | 2 MHz (nom.) |
| Resolution | <0.1% of deviation, or 1 Hz, whichever is greater (nom.) |
| Setting Uncertainty | $f \leq 1.5 \text{ GHz}$, $f_{\text{mod}} = 1 \text{ kHz}$, internal mode |
| | < 2% of setting + 20 Hz |
| Distortion | $f \leq 1.5 \text{ GHz}$, $f_{\text{mod}} = 1 \text{ kHz}$, deviation = 50 kHz |
| | < 2% (typ.) |
| Modulation Frequency Response ^[2] | DC/10 Hz to 100 kHz |
| | <3 dB (nom.) |

Note:

[1] The settable max. frequency offset for other frequency bands is $N \times 2\text{MHz}$.

[2] External modulation, measured at 100 kHz offset.

Phase Modulation (Option DSG5000-AMD)

| | |
|--|---|
| Modulation Source | Internal, External |
| Max. Deviation ^[1] | $f \leq 1.5$ GHz |
| | 5 rad (nom.) |
| Resolution | <0.1% of deviation, or 0.01 rad, whichever is greater (nom.) |
| Setting Uncertainty | $f \leq 1.5$ GHz, $f_{\text{mod}} = 1$ kHz, internal mode |
| | <1% of setting + 0.1 rad |
| Distortion | $f \leq 1.5$ GHz, $f_{\text{mod}} = 1$ kHz, deviation = 5 rad |
| | < 1% (typ.) |
| Modulation Frequency Response ^[2] | DC/10 Hz to 100 kHz |
| | <3 dB (nom.) |

Note:

[1] The settable max. frequency deviation for other frequency bands is $N \times 5$ rad.

[2] External modulation, measured at 5 rad deviation.

Pulse Modulation (Option DSG5000-PUL)

| | | |
|----------------------------|---|---------------|
| Modulation Source | Internal, External | |
| On/Off Ratio | $f \leq 6$ GHz | >80 dB (typ.) |
| | $6 \text{ GHz} < f \leq 11 \text{ GHz}$ | >70 dB (typ.) |
| | $f > 11 \text{ GHz}$ | >60 dB (typ.) |
| Rise/Fall Time (10%/90%) | <50 ns, 20 ns (typ.) | |
| Pulse Repetition Frequency | DC to 1 MHz | |

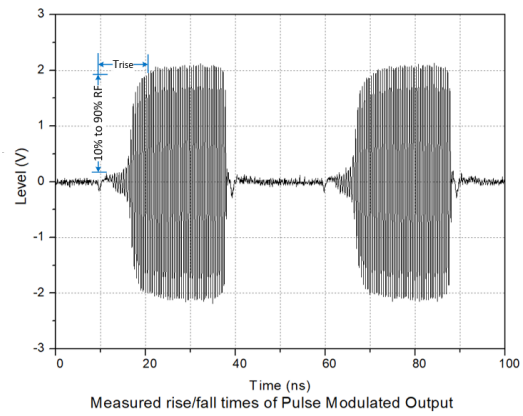
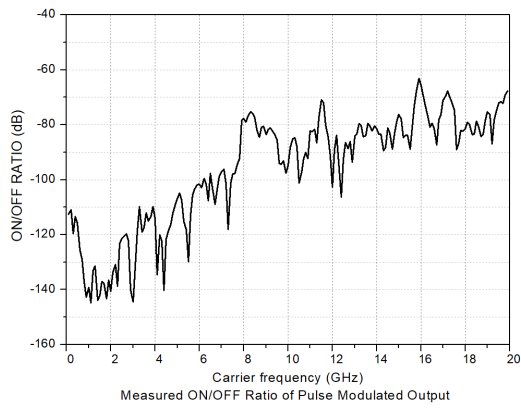

Pulse Generator

| | | |
|----------------|---|--------------------------|
| Operating Mode | Single, Train ^[1] | |
| Pulse Period | Setting Range | 40 ns to 170 s |
| | Resolution | 10 ns |
| Pulse Width | Setting Range | 10 ns to (170 s - 10 ns) |
| | Resolution | 10 ns |
| Trigger Delay | Setting Range | 10 ns to 170 s |
| | Resolution | 10 ns |
| Trigger Type | Auto, external trigger, external gate, trigger key, bus (USB and LAN) | |

Note:[1] Required to install the option DSG5000-PUG.

Pulse Train Generator (Option DSG5000-PUG)

| | | |
|-----------------------|--------------------------|----------------|
| Pulse Train Generator | Number of Pulse Patterns | 1 to 2,047 |
| | On/Off Time Range | 20 ns to 170 s |
| | Repetition Per Pattern | 1 to 256 |

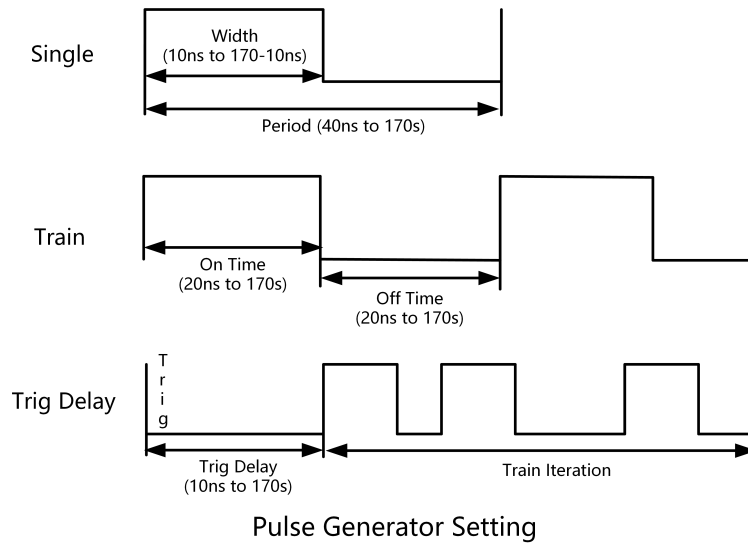

General Specifications

| Front Panel Connector (independent of each other) | | |
|---|----------------------|---------------------|
| RF Output | Impedance | 50 Ω (nom.) |
| | Connector | 3.5 mm male |
| External Trigger Input | Impedance | 1 k Ω (nom.) |
| | Connector | SMB male |
| | Trigger Voltage | 3.3 V TTL Level |
| Signal Valid Output | Connector | SMB male |
| | Output Voltage | 0 V/3.3 V (nom.) |
| Pulse Input or Output | Impedance | 50 Ω (nom.) |
| | Input/Output Voltage | 0 V/3.3 V (nom.) |
| | Connector | SMB male |
| Sweep Output | Connector | SMB male |
| | Output Voltage | 0 V to 10 V (nom.) |

Rear Panel Connector

| | | |
|---|---------------|---|
| External Modulation Signal Input | Impedance | 100 k Ω /600 Ω / 50 Ω (nom.) |
| | Coupling Mode | AC/DC |
| | Sensitivity | 1 V _{pp} for indicated depth (nom.) |
| | Connector | BNC female |
| 10 MHz IN (External Frequency Reference Input) | Impedance | 50 Ω (nom.) |
| | Connector | BNC female |
| 10 MHz OUT (External Frequency Reference Output) | Impedance | 50 Ω (nom.) |
| | Connector | BNC female |
| 4.8 GHz IN (Sync Reference Clock Input) | Impedance | 50 Ω (nom.) |
| | Connector | SMA female |
| 4.8 GHz OUT (Sync Reference Clock Output) | Impedance | 50 Ω (nom.) |
| | Connector | SMA female |

Communication Interface

| | | |
|---------------|-----------|--|
| USB3.0 HOST | Connector | A plug |
| | Protocol | 3.0 |
| | Qty. | 4 (2 on the front panel and 2 on the rear panel) |
| USB3.0 DEVICE | Connector | B plug |
| | Protocol | Support TMC protocol |
| LAN | Connector | RJ-45 |
| | Protocol | 10/100/1000Base-T, LXI-C |
| HDMI | Connector | A plug |
| | Protocol | HDMI 1.4 |

Display

| | | |
|-------------------|---------------------------------|--|
| Type | TFT LCD | |
| Resolution | 480×320 | |
| Dimensions | 3.5-inch | |
| Display Extension | Supports HDMI display extension | |

Mass Storage

| | | |
|--------------------|---|--------------|
| Mass Storage | Flash non-volatile memory (internal); USB storage device (not supplied) | |
| Data Storage Space | Flash non-volatile memory (internal) | 10 GB (nom.) |

Electromagnetic Compatibility and Safety

| | | |
|-------------------|--|---|
| EMC | Conform to EMC Directive 2014/30/EU | |
| | Conform to or above IEC61326-1: 2013/EN61326-1: 2013, EN IEC 61000-3-2:2019+A1, EN 61000-3-3:2013+A1:2019 | |
| | CISPR11:2009+A1 Class A | |
| | EN IEC 61000-3-2:2019+A1 | harmonic, Class A |
| | EN 61000-3-3:2013+A1:2019 | Voltage Flickers |
| | EN61000-4-2:2009 | ±4.0 kV (contact discharge) ±8.0 kV (air discharge) |
| | EN61000-4-3:2006+A1+A2 | 10 V/m (80 MHz to 1 GHz) 3V/m (1.4 GHz to 6 GHz) |
| | EN61000-4-4:2004+A1 | 2 kV power line |
| | EN61000-4-5:2006 | 1 kV (phase-to-neutral voltage) 2 kV (phase-to-earth voltage) 2 kV (neutral-to-earth voltage) |
| | EN61000-4-6:2009 | 10 V, 0.15-80MHz |
| EN61000-4-11:2004 | Voltage dip: 0% UT during half cycle 0% UT during 1 cycle 70% UT during 25 cycles Short interruption: 0% UT during 250 cycles | |
| Safety | EN 61010-1:2010+A1:2019 IEC 61010-1:2010+A1:2016 UL 61010-1: 2012 R7.19 CAN/CSA-C22.2 NO. 61010-1-12 + GI1 + GI2 (R2017) + A1 | |

Power Supply

| | | |
|-------------------------|------------------------------|--------|
| Input Voltage Range, AC | 100 V to 240 V (nom.) | |
| AC Frequency Range | 45 Hz to 440 Hz | |
| Power Consumption | With all the options working | <650 W |

Environment

| | | |
|-------------------|-----------------------------|----------------|
| Temperature Range | Operating Temperature Range | 0°C to +50°C |
| | Storage Temperature Range | -20°C to +70°C |
| Humidity Range | 0°C to 30°C | ≤ 90% RH |
| | 30°C to 40°C | ≤ 75% RH |
| | 40°C to 50°C | ≤ 45% RH |
| Altitude | Operating Height | below 3,000 |

Dimensions

| | | |
|-------------|--|--|
| (W x H x D) | 435 mm x 88 mm x 486.3 mm (without pads, with the connector) | |
| | 459 mm x 112 mm x 511 mm (with pads) | |

Weight

| | |
|---------------------------|--------|
| Weight (Package Excluded) | <14 kg |
|---------------------------|--------|

Calibration Interval

| | |
|----------------------------------|-----------|
| Recommended Calibration Interval | 18 months |
|----------------------------------|-----------|

Order Information and Warranty Period

Order Information

| | Description | Order No. |
|----------------------|--|-------------|
| Model | 2-CH microwave signal generator, 9 kHz to 12 GHz | DSG5122 |
| | 4-CH microwave signal generator, 9 kHz to 12 GHz | DSG5124 |
| | 6-CH microwave signal generator, 9 kHz to 12 GHz | DSG5126 |
| | 8-CH microwave signal generator, 9 kHz to 12 GHz | DSG5128 |
| | 2-CH microwave signal generator, 9 kHz to 20 GHz | DSG5202 |
| | 4-CH microwave signal generator, 9 kHz to 20 GHz | DSG5204 |
| | 6-CH microwave signal generator, 9 kHz to 20 GHz | DSG5206 |
| | 8-CH microwave signal generator, 9 kHz to 20 GHz | DSG5208 |
| Standard Accessories | Power Cord | - |
| Options | Pulse Modulation | DSG5000-PUL |
| | Pulse Train Generator | DSG5000-PUG |
| | Analog Modulation | DSG5000-AMD |
| | High Stability Clock (OCXO) | OCXO-D08 |
| | Rack Mount Kit | RM2031 |

NOTE:

For all the mainframes, accessories, and options, please contact the local office of **RIGOL**.

Warranty Period

Three years for the mainframe, excluding the accessories.

HEADQUARTER

RIGOL TECHNOLOGIES CO., LTD.
No.8 Keling Road, New District, Suzhou,
JiangSu, P.R.China
Tel: +86-400620002
Email: info@rigol.com

EUROPE

RIGOL TECHNOLOGIES EU GmbH
Carl-Benz-Str.11
82205 Gilching
Germany
Tel: +49(0)8105-27292-0
Email: info-europe@rigol.com

NORTH AMERICA

RIGOL TECHNOLOGIES, USA INC.
10220 SW Nimbus Ave.
Suite K-7
Portland, OR 97223
Tel: +1-877-4-**RIGOL**-1
Fax: +1-877-4-**RIGOL**-1
Email: info@rigol.com

JAPAN

RIGOL TECHNOLOGIES JAPAN, LLC
501, LATORRETTA, 2-37-1,
Numabukuro,
Nakano-Ku, Tokyo, Japan
Tel: +81-3-6262-8932
Fax: +81-3-6262-8933
Email: info-japan@rigol.com

RIGOL® is the trademark of **RIGOL TECHNOLOGIES CO., LTD.** Product information in this document subject to update without notice. For the latest information about **RIGOL**'s products, applications and services, please contact local **RIGOL** channel partners or access **RIGOL** official website: www.rigol.com