

01/2022

# Technical application guide 4DIMLT2 G2 CE LED drivers and T4T-C

Light is OSRAM

**OSRAM**

## Contents

<b>1 Introduction</b>	<b>03</b>	<b>4 Additional information</b>	<b>32</b>
1.1 OSRAM LED drivers with 4DIM functionality for outdoor and industrial applications	03	4.1 Insulation	32
1.2 4DIMLT2 product family	04	4.2 Cable preparation	32
1.3 Nomenclature	07	4.3 Incorrect wiring on the output side	33
1.4 Operating windows	07	4.4 Input overvoltage	33
1.4.1 Current foldback	08	4.5 Surge protection	33
1.4.2 Low input voltage protection	08		
<b>2 Features</b>	<b>09</b>	<b>5 Programming</b>	<b>34</b>
2.1 Operating current	09	5.1 Programming with DALI magic	34
2.1.1 Fixed current mode	09	5.2 Programming with NFC USB readers	34
2.1.2 LEDset2 mode	09	5.3 Programming with T4T-Field App	34
2.1.3 Tuning Factor	11		
2.2 Thermal derating and protection	11		
2.2.1 External temperature sensor	11		
2.2.2 Thermal management and Driver Guard feature	12		
2.3 Constant Lumen function	13		
2.4 Lamp operating time	13		
2.5 End of life	13		
2.6 Configuration Lock	15		
<b>3 Operating modes</b>	<b>16</b>		
3.1 On/off operating mode	16		
3.2 AstroDIM feature	17		
3.2.1 Wiring and feature activation	17		
3.2.2 Time-based mode	18		
3.2.3 Astro-based mode	19		
3.2.4 Presence detection in AstroDIM mode	22		
3.2.5 AstroDIM SD-triggered	23		
3.3 StepDIM feature	24		
3.3.1 StepDIM	25		
3.3.2 StepDIM inverse	26		
3.3.3 Autodetect, ON/OFF-StepDIM inverse	26		
3.3.4 Autodetect, AstroDIM-StepDIM inverse	27		
3.4 MainsDIM feature	28		
3.5 DALI operating mode	29		
3.5.1 DALI-2	30		
3.5.2 Additional functions	30		
3.6 DC operation feature	31		

### Please note:

All information in this guide has been prepared with great care. OSRAM, however, does not accept liability for possible errors, changes and/or omissions. Please check [www.osram.com](http://www.osram.com) or contact your sales partner for an updated copy of this guide. This technical application guide is for information purposes only and aims to support you in tackling the challenges and taking full advantage of all opportunities the technology has to offer. Please note that this guide is based on own measurements, tests, specific parameters and assumptions. Individual applications may not be covered and need different handling. Responsibility and testing obligations remain with the luminaire manufacturer/OEM/application planner.

# 1 Introduction

## 1.1 OSRAM LED drivers with 4DIM functionality for outdoor and industrial applications

Long lifetime, low maintenance costs and high efficiency are very important for outdoor and industrial applications. OPTOTRONIC® LED drivers for outdoor applications meet these requirements and unlock the full potential of LED-based light sources.

Thanks to the high flexibility of the programmable OPTOTRONIC® 4DIMLT2 G2 LED drivers, LED luminaire systems can be optimized to the on-site conditions and cost. With the four integrated dimming functions (4DIM), significant energy saving and a reduction of greenhouse gas emissions can be achieved.

The NFC interface implemented in the 4DIMLT2 G2 family enables an easy and safe way of programming LED drivers during the production process and also in the field. The parameters can be transferred without the need to power the LED driver, which saves time compared to a programming process using the DALI-2 interface.

Due to the large operating window (voltage/current) of these LED drivers, both OSRAM LED modules for outdoor applications and customer-specific LED modules can be operated. This also means that the overall amount of different LED drivers on stock can be kept low and that the overall complexity of luminaire maintenance over the entire life cycle can be reduced.

The drivers are DALI-2-certified and support stepless dimming, status requests, and addressing of each individual light point. Compared to devices based on DALI version 1, DALI-2-certified drivers ensure a higher interoperability in the system. Moreover, DALI-2 ensures better integration of additional valuable data services thanks to the DALI DATA extensions part -251 (Luminaire Info), part -252 (Energy Reporting) and part -253 (Diagnostic Data).

With the LEDset2 interface, OSRAM has created a new path towards standardizing the communication between the LED driver and the LED modules. Without reprogramming, LEDset2 ensures optimal efficiency, a high level of reliability and the adaptability of the LED drivers to the latest LED technologies.



































Finally, due to integrated overvoltage protection, LED drivers with 4DIM functionality provide a high level of protection against common mode surges of up to 10 kV for class I and II luminaires.

### 1.2 4DIMLT2 product family

The 4DIMLT2 product family consists of five different output power classes of up to 165 W. All five types have the same 4DIM dimming capabilities and the LEDset2 interface.

They can be programmed via the Tuner4TRONIC® software using the DALI-2 or NFC interface. The following overview shows the main features of these LED drivers.

**Table 1: Family overview**

					
Product name	OT 20/170-240/1A0 4DIMLT2 G2 CE	OT 40/170-240/1A0 4DIMLT2 G2 CE	OT 75/170-240/1A0 4DIMLT2 G2 CE	OT 110/170-240/1A0 4DIMLT2 G2 CE	OT 165/170-240/1A0 4DIMLT2 G2 CE
<b>General</b>					
Maximum power	 22 W	40 W	75 W	110 W	165 W
Input voltage L/N	 220–240 V	220–240 V	220–240 V	220–240 V	220–240 V
Nominal output voltage	 10–38 V	15–56 V	35–115 V	80–220 V	130–260 V
Output current range	 70–1050 mA	70–1050 mA	70–1050 mA	70–1050 mA	70–1050 mA
Surge (dif/com)	6/10 kV	6/10 kV	6/10 kV	6/10 kV	6/10 kV
Insulation (primary/secondary)	 SELV	 SELV	 SELV	 Double	 Double
Insulation of casing	 Double	 Double	 Double	 Double	 Double
Stand-by power	< 0.5 W	< 0.5 W	< 0.5 W	< 0.5 W	< 0.25 W
<b>Dimming features</b>					
DALI-2	 ✓	✓	✓	✓	✓
StepDIM (SD(2))	 ✓	✓	✓	✓	✓
StepDIM inverse (SD(2))	 ✓	✓	✓	✓	✓
AstroDIM (astro-based)	 ✓	✓	✓	✓	✓
AstroDIM (time-based)	 ✓	✓	✓	✓	✓
MainsDIM	 ✓	✓	✓	✓	✓
Presence detection	 ✓	✓	✓	✓	✓
<b>Other features</b>					
Constant Lumen function	 ✓	✓	✓	✓	✓
DALI-2 DATA	 ✓	✓	✓	✓	✓
	 ✓	✓	✓	✓	✓
LEDset2	 ✓	✓	✓	✓	✓
External NTC	 ✓	✓	✓	✓	✓
Configuration Lock	 ✓	✓	✓	✓	✓
Tuning Factor	 ✓	✓	✓	✓	✓
Driver Guard T, P	 ✓	✓	✓	✓	✓
<b>Programming software</b>					
Tuner4TRONIC®	 ✓	✓	✓	✓	✓

### DALI-2



In this operating mode, the driver can be controlled by a DALI application controller via the bidirectional DALI interface and it supports status request queries. Through the application controller, the driver can be integrated into a light management system.

The drivers are DALI-2-certified and support stepless dimming, status requests, and addressing of each individual light point. Compared to devices based on DALI version 1, DALI-2-certified drivers ensure more functions and a higher interoperability in the system.

### StepDIM/StepDIM inverse



Dimming via an external control phase: Predefined dimming levels can be varied via the Tuner4TRONIC® software and the polarity of the phase. The SD2 port also allows control via a mains-powered presence sensor.

### AstroDIM/presence detection



Automatic dimming via an integrated timer (no real-time clock): Five independent dimming levels and zones can be set with the Tuner4TRONIC® software. Brightness variation is possible in combination with an external presence sensor.

### MainsDIM



Dimming via mains voltage amplitude: This feature is often used in combination with magnetic ballasts in outdoor applications. The dimming behavior can be set via the Tuner4TRONIC® software.

### CLO (constant lumen output)



The decrease in the luminous flux of an LED module can be compensated over its entire lifetime via a preprogrammed current curve. This not only ensures stable lighting but also saves energy and increases the lifetime of the LEDs.

### Monitoring Data



LED drivers with this feature offer additional operation and status information according to the DALI-2 DATA extensions (Parts -251, -252 and -253) such as energy consumption, power, operating time, overvoltage or undervoltage etc. By using these data, it is possible to offer predictive maintenance and an overall better lighting service. Moreover, it makes the light management system intelligent.

The data can also be visualized in the Tuner4TRONIC® software.

### LEDset (Generation 2)



LEDset2 is an improved LED module interface for the combination of single or multiple LED modules with one LED driver via a single analog control line. This interface enables external current setting and temperature monitoring. The LEDset2 interface has no auxiliary supply and is not compatible with LEDset (Generation 1). LEDset2 has an absolute current coding, while LEDset (Generation 1) only has a relative one.

### External temperature sensor



This feature allows the temperature protection of the LED module or the complete luminaire in hot ambient temperatures via an external sensor (e.g. NTC, negative temperature coefficient resistor). The derating can be modified via the Tuner4TRONIC® software.

### Integrated overvoltage protection



The 4DIMLT2 G2 CE drivers have an integrated overvoltage protection of up to 6kV for differential and 10kV for common-mode overvoltages.

### Configuration Lock



This feature is an advancement of OEM Key, which allows controlling the access rights for individual features within the LED driver via Tuner4TRONIC® software and assigning different rights to the luminaire manufacturer, to the service team and to the general user. Assigning user rights also allows offering “light as a service” and still maintaining total control over who may change what within the device or luminaire.

### Tuning Factor



Within limits predefined by the luminaire manufacturer, this feature allows an adjustment of the amount of light in the field or in production. Thus, one luminaire can manage different lumen packages. If the feature is combined with LEDset2, other lumen packages can also be achieved, which differ in terms of resistor coding.

### Driver Guard T, P



By default, the internal protection mechanisms of the LED driver are designed for maximum performance and temperature, however, not for those of the luminaire. By means of this feature, the performance and temperature derating of the LED driver can be adjusted according to the luminaire performance, maximizing the system reliability.

### 1.3 Nomenclature

The product name of each OPTOTRONIC® 4DIMLT2 G2 CE LED driver is defined as shown below.

**Figure 1: OT 40/170-240/1A0 4DIMLT2 G2 CE**

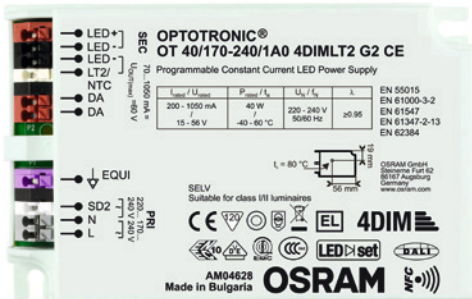

- OT:** OPTOTRONIC® LED driver
- 40:** Power class: 40 W
- 170-240:** Input voltage range (L/N): 170-240 V
- 1A0:** Max. output current: 1050 mA
- 4DIM:** 4DIM functionality (DALI, StepDIM, AstroDIM, MainsDIM)
- LT2:** LEDset2 (LED module interface)
- G2:** Generation 2
- C:** Compact housing shape
- E:** For exterior use under specific conditions

### 1.4 Operating windows

The OPTOTRONIC® 4DIMLT2 G2 CE LED driver family is split up into four different power classes to provide the best suitable power supply for different applications. The nominal output current of 200–1050 mA is available in the following power packages.

**Table 2: 4DIMLT2 G2 CE maximum allowed output power**

Type	P <sub>max</sub>	t <sub>a</sub>	V <sub>in</sub> (nominal)
OT 20/170-240/1A0 4DIMLT2 G2 CE	22 W	-40 ... +60 °C	220–240 V <sub>AC</sub>
OT 40/170-240/1A0 4DIMLT2 G2 CE	40 W	-40...+60 °C	220–240 V <sub>AC</sub>
OT 75/170-240/1A0 4DIMLT2 G2 CE	75 W <sup>1)</sup>	-40 ... +55 °C	220–240 V <sub>AC</sub>
OT 110/170-240/1A0 4DIMLT2 G2 CE	110 W <sup>1)</sup>	-40 ... +55 °C	220–240 V <sub>AC</sub>
OT 165/170-240/1A0 4DIMLT2 G2 CE	165 W <sup>1)</sup>	-40 ... +55 °C	220–240 V <sub>AC</sub>

1) At input voltages below 190 V, the driver protects itself as shown in figure 4.

Figure 2 gives a complete overview of the possible 4DIMLT2 operating windows.

**Figure 2: Overview of 4DIMLT2 G2 CE operating windows**

- OT 20/170-240/1A0 4DIMLT2 G2 CE
- OT 40/170-240/1A0 4DIMLT2 G2 CE
- OT 75/170-240/1A0 4DIMLT2 G2 CE
- OT 110/170-240/1A0 4DIMLT2 G2 CE
- OT 165/170-240/1A0 4DIMLT2 G2 CE

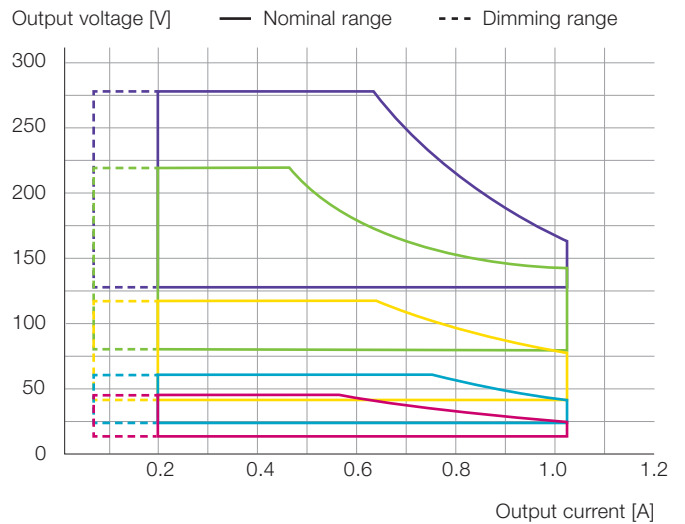

**Table 3: 4DIMLT2 G2 CE operating range**

Type	Minimum dimming current	Minimum nominal current	Maximum nominal current	Minimum output voltage	Maximum output voltage
OT 20/170-240/1A0 4DIMLT2 G2 CE	70 mA	200 mA	1050 mA	10 V	38 V
OT 40/170-240/1A0 4DIMLT2 G2 CE	70 mA	200 mA	1050 mA	15 V	56 V
OT 75/170-240/1A0 4DIMLT2 G2 CE	70 mA	200 mA	1050 mA	35 V	115 V
OT 110/170-240/1A0 4DIMLT2 G2 CE	70 mA	200 mA	1050 mA	80 V	220 V
OT 165/170-240/1A0 4DIMLT2 G2 CE	70 mA	200 mA	1050 mA	130 V	260 V

It is possible to operate the driver below the minimum nominal current through initial setting of the output current.

**Warning:**

When LED drivers are permanently operated below the minimum nominal current, it is necessary to ensure compliance with relevant IEC standards (for example mains current distortion and power factor). Please consider that the certificates are only valid within the nominal output current range.

### 1.4.1 Current foldback

The intelligent 4DIMLT2 family allows a safe start-up of the system, even if the power consumption or the total forward voltage of the LED module exceeds the maximum output power or voltage of the LED driver. In this case, the unit reduces the current until the maximum output voltage [1] or power [2] is not exceeded anymore. If no stable operating point is achieved, the unit switches on and off continuously or switches off completely.

**Figure 3: Current foldback (example: OT 40 4DIMLT2 G2 CE)**

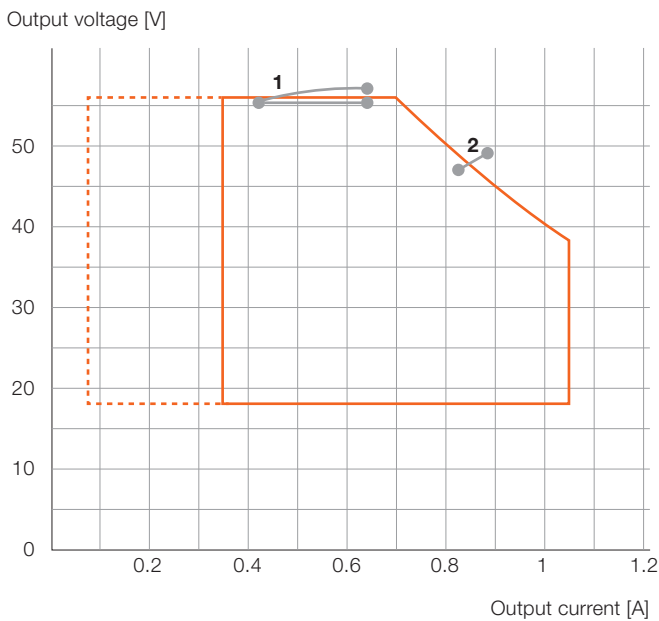

### 1.4.2 Low input voltage protection

In case of a very low input voltage, the driver protects itself against being damaged by high input currents. The behavior of the driver can be seen in figure 4.

**Figure 4: Input voltage vs. output power 4DIMLT2 G2 CE driver**

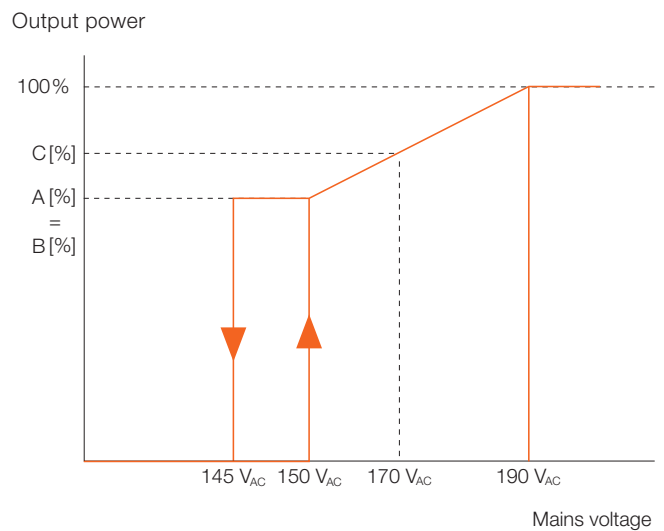

	A [%]	=	B [%]	C [%]
OT 20/170-240/1A0 4DIMLT2 G2 CE	40		40	75
OT 40/170-240/1A0 4DIMLT2 G2 CE	68		68	85
OT 75/170-240/1A0 4DIMLT2 G2 CE	70		70	85
OT 110/170-240/1A0 4DIMLT2 G2 CE	70		70	85
OT 165/170-240/1A0 4DIMLT2 G2 CE	50		50	75



# 2 Features

## 2.1 Operating current

Flexible current setting allows taking advantage of the continuously improving LED technology and building a future-proof system. The 4DIMLT2 family offers two modes for current setting, which can be set via the Tuner4TRONIC® software:

- Fixed current: Current setting via programmable interface
- LEDset2: Current setting via the LEDset2 interface

Figure 5: Setting of the operating current



Without any resistor connected to the LEDset2 interface, the factory default current is 700 mA. As soon as the LED driver detects a resistor value for more than 3 seconds within the valid resistor range of 4.75 kΩ (1050 mA) and 24.9 kΩ (200 mA), it switches to the LEDset2 mode.

### 2.1.1 Fixed current mode

To use the fixed current mode, it has to be selected in the Tuner4TRONIC® software. The minimum and maximum rated output currents are displayed according to the selected LED driver. The output current of the LED driver can be set by changing the value in the “Operating Current” field.

### 2.1.2 LEDset2 mode

The LEDset2 interface (LEDset generation 2) is a standardized LED module interface to set the right output current and establish an easy and low-cost temperature protection for the connected LED module. This multi-vendor interface is suitable for LED modules connected in parallel or in series.

**Note:**

In the following figures, the LED module is displayed in a simplified way. The real number of LEDs depends on the output voltage of the driver.

Figure 6: LEDset2 parallel connection

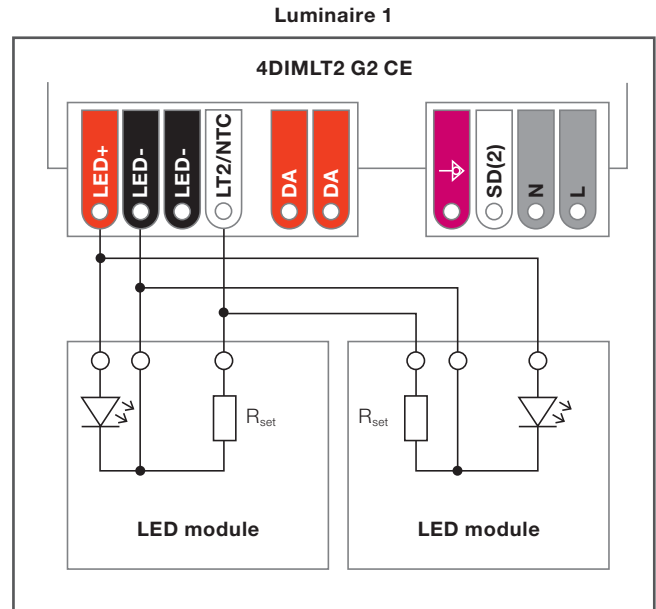
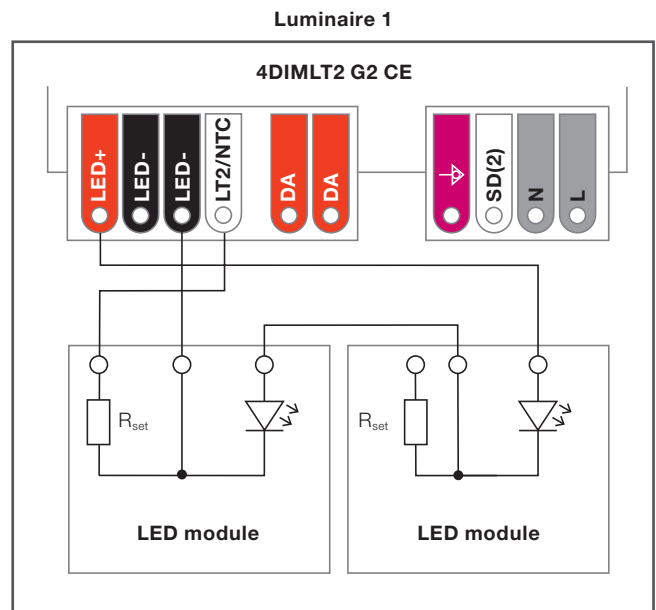
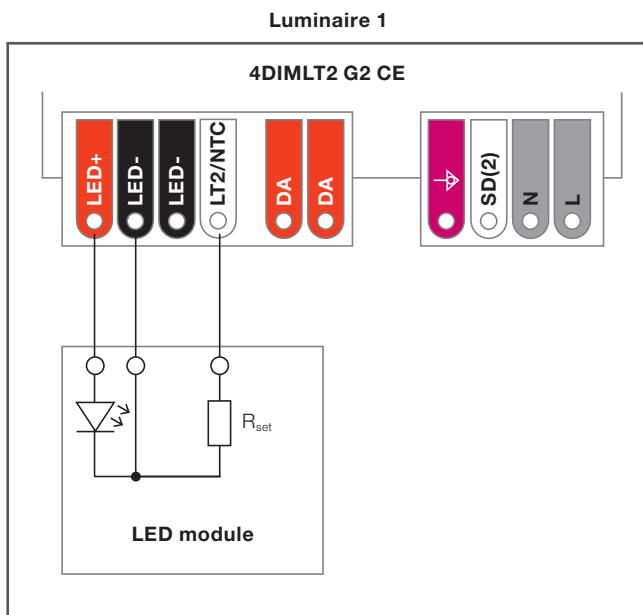

Figure 7: LEDset2 series connection



The output current of the LED driver can be set using an externally connected resistor (min. power rating 50mW, max. tolerance 0.5%). This provides the possibility to set the LED current manually without the need for an additional programming of the LED driver. With a resistor mounted on the LED module as shown in figure 8, the correct LED current can be set automatically. With this resistor, the desired current for the LED module is set according to the used LED bin and needed lumen output, offering a real plug-and-play solution and making the system future-proof.

**Figure 8: R<sub>set</sub> connection**



To achieve a more accurate current setting, the second LED- terminal of the LED driver can be used as shown in figure 9. This increases the accuracy by roughly 0.5%.

**Figure 9: R<sub>set</sub> connection with higher accuracy**

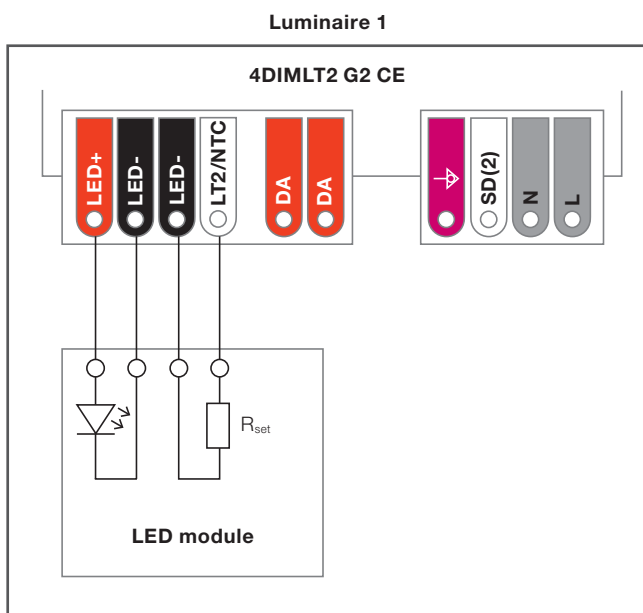

The LEDset2 coding for the 4DIMLT2 family is shown in the following graph.

**Figure 10: LEDset2 coding**

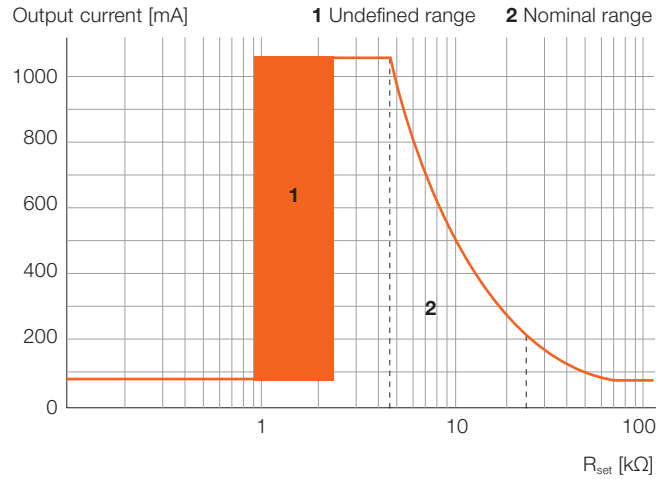

The corresponding output current can be calculated with the following formula within the valid resistor range ( $R_{set} = 4.75\text{--}24.9\text{ k}\Omega$ ):

$$I_{out} [A] = \frac{5V}{R_{set} [\Omega]} \times 1000$$

The undefined range should be avoided because the output current of the LED driver is not predictable.

Table 4 gives an overview of commonly used current values and the appropriate resistor values.

**Table 4: LEDset2 resistor coding**

<b>I<sub>out</sub> [mA] reference</b>	<b>R<sub>set</sub> [kΩ] [tolerance ≤ 0.5 %]</b>	<b>I<sub>out</sub> [mA] nominal</b>
Open circuit	> 71	70
200	24.9	201
350	14.3 (E192)	349
500	10.0 (E192)	500
700	7.15 (E192)	699
1050	4.75 (E192)	1050
Undefined	0.9–2.37	1050/70
Short circuit	< 0.9	70

For further details, please consult the LEDset2 application guide, which can be downloaded at [www.osram.com/ledset](http://www.osram.com/ledset).

### 2.1.3 Tuning Factor

Modern street lighting has a high energy saving potential as efficient LED technology allows light planners and luminaire manufacturers to perfectly adapt the behavior of the luminaire to the requirements of the illuminated street. On the other hand, this flexibility increases the complexity of maintaining the installation for cities and installers.

The Tuning Factor feature from OSRAM helps to reduce this complexity to a minimum as it enables installers to adapt the settings of a luminaire according to their current needs.

#### Example:

A luminaire manufacturer develops a luminaire which can be operated within a range of 2,000–4,000lm. The installer commissioned by the city can then use the Tuner4TRONIC® Field application to adjust the lumen output via the NFC programming interface to the level that is needed, while not exceeding the limits set by the luminaire manufacturer.

Figure 11: Tuner4TRONIC® user interface: Tuning Factor

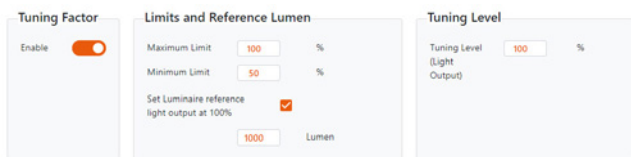

Use this functionality to limit the Light Output using the T4T Field App. Don't forget to update the access rights with the Configuration Lock.

#### Maximum limit:

This is the maximum operating current set by the luminaire manufacturer. It is equivalent to 100 %.

#### Minimum limit:

This is the minimum definable output current level. Valid range: 50–100 %.

#### Luminaire reference light output:

This value indicates a reference light output of the luminaire at 100 % output current. This enables the installer to easily adjust the light output in lumen instead of the output current.

#### Tuning level:

This is the current tuning level set by the installer.

The “limits and reference lumen” can be independently protected by the Configuration Lock feature in order to avoid unauthorized usage of this feature outside the limits defined by the luminaire manufacturer.

## 2.2 Thermal derating and protection

### 2.2.1 External temperature sensor

By connecting an external temperature sensor to the NTCset port of the 4DIMLT2 G2 CE LED driver, a very easy and cost-efficient temperature protection of the LED module can be realized. As an example, an NTC (negative temperature coefficient resistor) can be mounted on the LED module and connected as shown in figure 12. In case the thermal protection feature is enabled and nothing is connected to the NTCset terminal, the driver delivers 100 % light output.

Figure 12: NTC connection

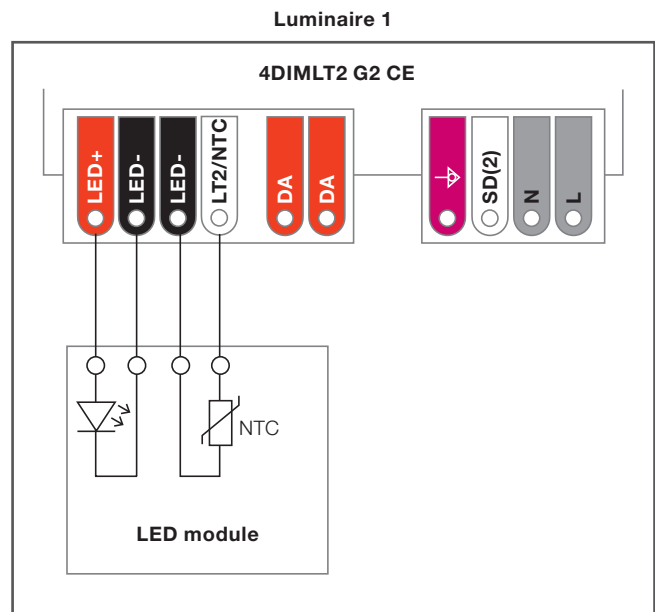

**Resistor-based mode**

The resistor-based mode is activated by default. If the connected resistor sensor value falls in the range between 6.3 and 5.0 kΩ, the output current is continuously lowered down to 50%. If the value falls further below 4.3 kΩ, the output is switched off completely until the sensor reaches 5.0 kΩ again. The complete switch-off can be deactivated by clicking on the “Shut Off” check box.

In this mode, a common NTC can be used to achieve a fixed thermal protection as shown in table 5. The specified temperatures can vary, depending on the used NTC component and the corresponding tolerances.

**Table 5: Overview of standard NTCs**

NTC type	Start derating temperature [6.3 kΩ]	End derating temperature <sup>1)</sup> [5.0 kΩ]	Shut-off temperature [4.3 kΩ]
22 kΩ	56 °C	62 °C	67 °C
33 kΩ	66 °C	72 °C	77 °C
47 kΩ	75 °C	83 °C	87 °C
68 kΩ	85 °C	92 °C	97 °C

1) Switch-on temperature in case the temperature has reached the shut-off condition

**2.2.2 Thermal management and Driver Guard feature**

The 4DIMLT2 G2 CE LED driver family has a reversible internal thermal protection. If the maximum allowed LED driver temperature is exceeded, the LED driver starts derating the output current down to 50%. If the temperature keeps increasing, the LED driver switches off. It switches back on at the maximum allowed temperature.

In outdoor installations especially, the lifetime and reliability of a luminaire is very important. As the lifetime of a luminaire always depends on the operating temperature of the components, the “Driver Guard” feature helps limiting the LED driver’s temperature during its operation. The thermal behavior of the LED driver can be activated at lower temperatures using the “Prestart Derating” setting shown in the figure below.

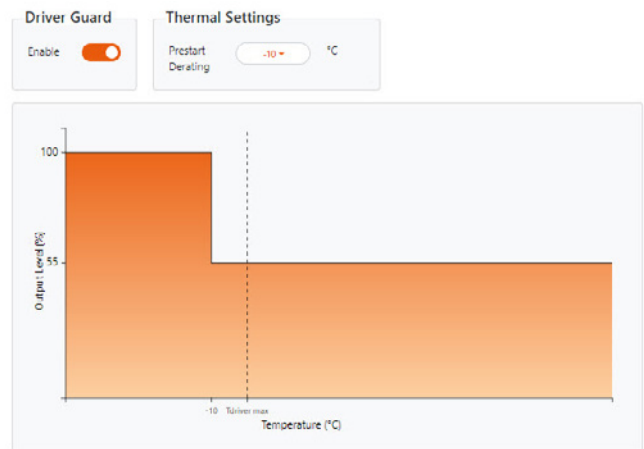

**Note:**

The luminaire manufacturer is responsible for the proper thermal design of the luminaire. The temperature indicated in this feature might significantly differ from the t<sub>c</sub> temperature mentioned on the top of the LED driver. To achieve the lifetime data of the LED driver, the luminaire manufacturer needs to ensure that the maximum t<sub>c</sub> temperature is never exceeded.

### 2.3 Constant Lumen function

Over the lifetime of an LED module, the light output drops due to the aging process of the LEDs. To achieve a constant light output of the module, the LED driver stores the operating hours of the LED module and increases the output current to react to the light output drop. To set this feature according to the applied LED module, the Tuner4TRONIC® software can be used as shown, for example, in figure 13.

The output levels have to be steadily increasing from the beginning to the end.

The output level cannot fall below the minimum physical dimming level of the LED driver, even if the software displays a lower value.

Next to the table, the estimated energy savings are calculated as shown in figure 13. This value is only an estimation because it does not consider, for example, the LED  $V_f$  behavior and efficiency of the driver.

The exact values for programming the Constant Lumen function for the connected LED module need to be obtained from the corresponding LED or LED module supplier.

### 2.4 Lamp operating time

The LED driver monitors the operating hours of the connected LED module. In case of a fault of the LED driver or module, the lamp operating time has to be (re)set accordingly with the Tuner4TRONIC® software. The lamp operating time also has an influence on the constant lumen function and the “end of life” feature. It can be set using the Tuner4TRONIC® software as shown in figure 14.

Figure 14: Lamp operating time (10 kh)

Actual lamp operating time can be displayed and edited in the feature tab "Operating Time for ECGs without Monitoring Data".

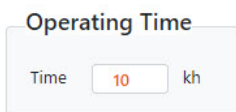
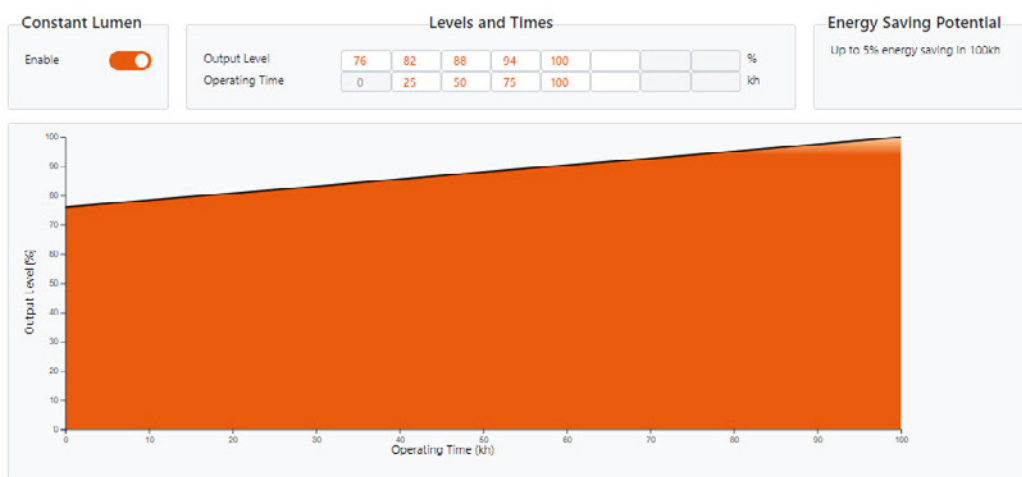

Figure 13: Constant lumen programming graph (operating time = 10 kh)



Lamp operating time allows the display and editing of the actual on-time of the LED module, which is the basis for the CLO (constant lumen output) profile. Drivers that feature monitoring data (DiiA: DALI part -253) use “Light Source Diagnostics and Maintenance: On Time – Resettable” to display elapsed time for CLO. “On-Time – Resettable” can be edited by reading Monitoring Data from drivers with T4T-P4.

Cluster	Name	Value	Unit
	Output Power Limitation	N/A	
	Control Gear Power Limitation Counter	N/A	
	Thermal Derating	N/A	
	Thermal Derating Counter	N/A	
	Thermal Shutdown	N/A	
	Thermal Shutdown Counter	N/A	
	Temperature	N/A	°C
	Output Current Percent	100	
	Start Counter - Resettable	3	
	Start Counter	25	
	On Time - Resettable	0:21	Minimum
	On Time	0:22	Minimum

### 2.5 End of life

The LED driver can indicate that a preprogrammed lifetime of the connected LED module is reached and the module should be replaced. This function has to be activated in advance via the Tuner4TRONIC® software. The “end of life” indication can be programmed as shown in figure 15.

Figure 15: “End of life” setting

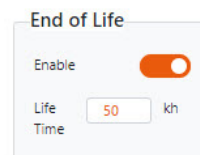

If the specified lifetime is reached, the LED driver indicates this through a lower light output during the first 10 minutes of the switch-on period as shown in figure 16.

**Figure 16: “End of life” behavior without switch-on fade time**

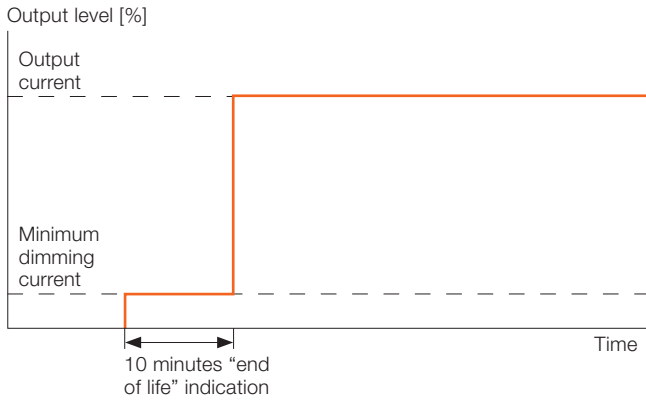

If a switch-on fade time is set, it is overridden by the “end of life” functionality as shown in figure 17. After 10 minutes, the output current is set according to the current switch-on fade time level.

**Figure 18 : “End of life” behavior with short switch-on fade time**

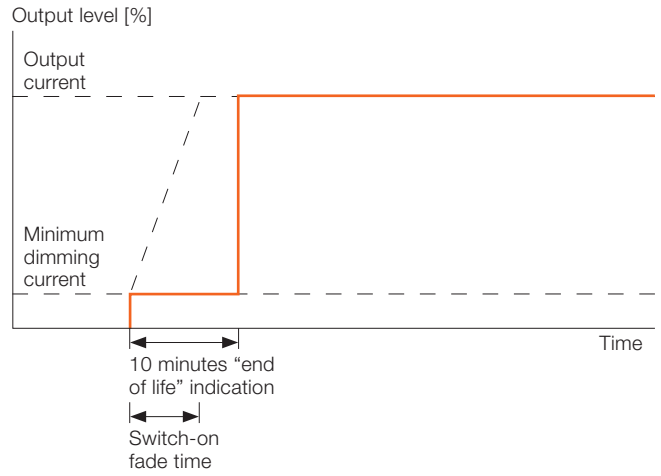

**Note:**  
In DC operation, the “end of life” indication is deactivated until the next power-on/off cycle or DALI operation.

**Figure 17: “End of life” behavior with long switch-on fade time**

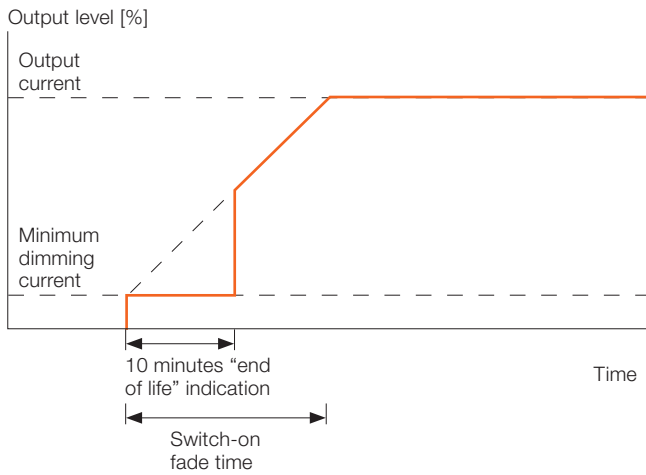

If the switch-on fade time is shorter than 10 minutes, the output current is directly switched to the nominal output level after the “end of life” indication as shown in figure 18.

## 2.6 Configuration Lock

The protection of the LED driver settings is mandatory to guarantee a safe operation of a luminaire over its entire life-time. In order to meet growing market demands to change settings of a luminaire in the field, OSRAM developed a new Configuration Lock, allowing a safe operation of the luminaire while also giving the end customers the possibility to adapt the settings of the luminaire in the field. With this approach, the luminaire manufacturer keeps the complete control on the boundaries defining how his product will be operated.

### Example 1:

Luminaire manufacturer locks all settings, no in-field changes possible.

The luminaire manufacturer sets a “Master Key” and locks all the features. Without knowing the programmed “Master Key,” nobody can change the LED driver settings anymore. Features can be kept unlocked by selecting “Everyone” in the corresponding line.

#### Configuration Lock

Enable:

Master Key: 1 2 3 4

Service Key: 0 0 0 0

**Please do not enter your company secret master and service keys in public mode!**

Please apply for a private company workspace at [T4Support@osram.com](mailto:T4Support@osram.com) if you use password protection in your LED drivers.

#### Access to Features

	Everyone	Only Master
Luminaire Info	<input type="radio"/>	<input checked="" type="radio"/>
Emergency Mode	<input type="radio"/>	<input checked="" type="radio"/>
Dimming Levels	<input type="radio"/>	<input checked="" type="radio"/>
Operating Modes	<input type="radio"/>	<input checked="" type="radio"/>
Driver Guard	<input type="radio"/>	<input checked="" type="radio"/>
Thermal Protection	<input type="radio"/>	<input checked="" type="radio"/>
End of Life	<input type="radio"/>	<input checked="" type="radio"/>
Constant Lumen	<input type="radio"/>	<input checked="" type="radio"/>
Tuning Factor: Level	<input type="radio"/>	<input checked="" type="radio"/>
Tuning Factor: Limits / Lumen	<input type="radio"/>	<input checked="" type="radio"/>
Operating Current	<input type="radio"/>	<input checked="" type="radio"/>
Select all	<input type="checkbox"/>	<input checked="" type="checkbox"/>

The service password is a premium functionality. You can create a configuration file using this feature but when programming the drivers, a fee per device will incur. Please contact your OSRAM sales representative for more information.

### Example 2:

Luminaire manufacturer defines boundary conditions and enables in-field programming.

The luminaire manufacturer defines his “Master Key” and keeps the full access rights to the settings of the LED driver. An additional “Service Key” can be set to allow people knowing this key to adapt the corresponding feature(s) of the LED driver.

In this example, people who received the “Service Key” (e.g. service personnel) can change the light output of the luminaire using the tuning factor level. As the “Limits and Reference Lumen” of the Tuning Factor feature is locked, the user can only adapt the light output within the limits defined by the luminaire manufacturer. In this case, all settings related to operating modes and AstroDIM can be changed.

#### Configuration Lock

Enable:

Master Key: 1 2 3 4

Service Key: 5 6 7 08

**Please do not enter your company secret master and service keys in public mode!**

Please apply for a private company workspace at [T4Support@osram.com](mailto:T4Support@osram.com) if you use password protection in your LED drivers.

#### Access to Features

	Everyone	Service and Master	Only Master
Luminaire Info	<input type="radio"/>	<input type="radio"/>	<input checked="" type="radio"/>
Emergency Mode	<input type="radio"/>	<input type="radio"/>	<input checked="" type="radio"/>
Dimming Levels	<input checked="" type="radio"/>	<input type="radio"/>	<input type="radio"/>
Operating Modes	<input checked="" type="radio"/>	<input type="radio"/>	<input type="radio"/>
Driver Guard	<input type="radio"/>	<input type="radio"/>	<input checked="" type="radio"/>
Thermal Protection	<input type="radio"/>	<input type="radio"/>	<input checked="" type="radio"/>
End of Life	<input type="radio"/>	<input type="radio"/>	<input checked="" type="radio"/>
Constant Lumen	<input type="radio"/>	<input type="radio"/>	<input checked="" type="radio"/>
Tuning Factor: Level	<input type="radio"/>	<input checked="" type="radio"/>	<input type="radio"/>
Tuning Factor: Limits / Lumen	<input type="radio"/>	<input type="radio"/>	<input checked="" type="radio"/>
Operating Current	<input type="radio"/>	<input type="radio"/>	<input checked="" type="radio"/>
Select all	<input type="checkbox"/>	<input type="checkbox"/>	<input type="checkbox"/>

# 3 Operating modes

The operating modes of a 4DIMLT2 G2 CE LED driver can be selected using the Tuner4TRONIC® software. Only one mode can be selected.

**Figure 19: Operating/dimming modes**

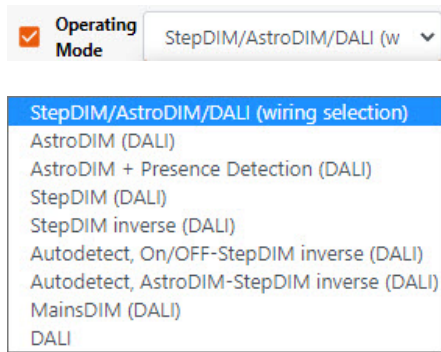

**Note:**

DALI always has a higher priority than the selected operating mode and can be activated by a valid DALI command in every mode. After a power-off/on cycle, the LED driver operates in the originally selected dimming mode again.

The LED driver offers the possibility to select one of the two dimming modes “StepDIM (DALI)” or “AstroDIM (DALI)” via external wiring in case the default dimming mode “StepDIM/AstroDIM/DALI (wiring selection)” is set. Please see chapter 3.2.1 for wiring information.

**3.1 On/off operating mode**

4DIMLT2 G2 CE LED drivers can also be used in a simple on/off operating mode. One of the following dimming modes needs to be selected:

- StepDIM/AstroDIM/DALI (wiring selection) – DALI and SD(2) port not connected
- StepDIM (DALI) – DALI and SD(2) port not connected
- DALI – DALI port not connected

**Note:**

Be aware that the parameters set in these operating modes also have an influence on the behavior of the LED driver in the on/off operating mode.

**Figure 20: Wiring for on/off operation**

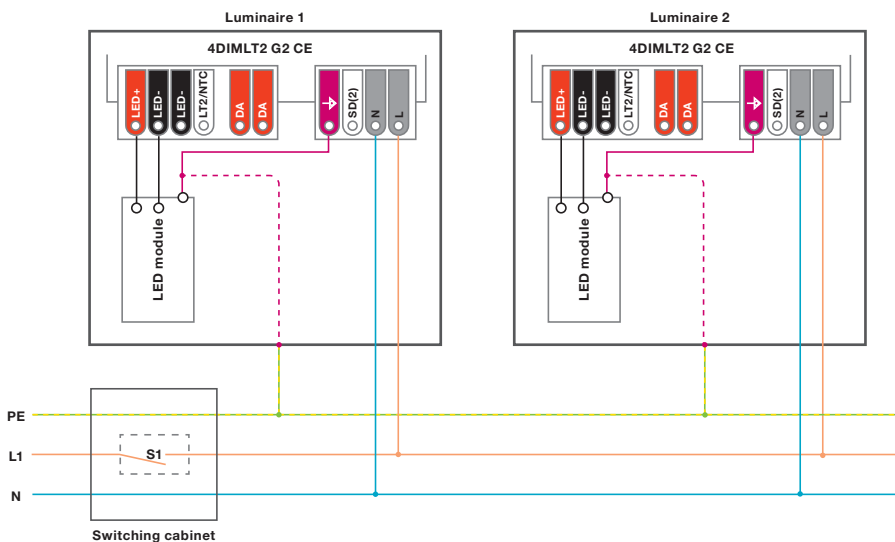



### 3.2 AstroDIM feature

The AstroDIM feature allows an autonomous dimming without the need for an additional control line. The 4DIMLT2 G2 CE LED drivers support up to five independent dimming levels and flexible settings of fade times between the individual dimming levels.

The output levels can be set to 0% (OFF) or between 10% and 100% in steps of 1%.

In addition, switch-on and switch-off fade times can be programmed at the beginning and the end of a switching cycle to allow for further energy savings during the twilight phase. This function is also helpful for installations with a pedestrian crossing where no specific infrastructure is available to switch the pedestrian crossing illumination independently of the rest of the street light illumination.

Two different modes for AstroDIM are supported:

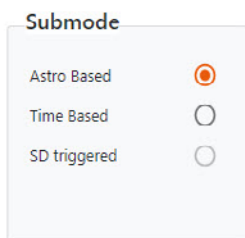

**Time-based:** The dimming profile defined in the reference schedule is referenced to the switch-on time of the LED driver.

**Astro-based:** The dimming profile defined in the reference schedule is referenced to the annual average middle of the night, which is calculated based on the theoretical sunrise and sunset times.

The LED driver does not have a real-time clock. The internal reference clock is derived from the mains frequency and the driver detects if it is connected to a 50 Hz or 60 Hz supply system, assuming a time base of 20 ms or 16.6 ms. This allows a synchronized switching of all units. In case of DC operation (see chapter 3.6), the dimming mode is stopped until the AC voltage is applied again and a power-off/on cycle is performed.

**Warning:**

If the output level is set below the minimum physical dimming level of the LED driver (except OFF), the minimum dimming current is used. The software still displays the original value. If the output level falls below the minimum allowed dimming current, the value is visualized in red.

#### 3.2.1 Wiring and feature activation

There are two ways to activate the AstroDIM mode:

- **Option 1: By external wiring**  
Selected dimming mode (factory default): “StepDIM/AstroDIM/DALI (wiring selection)”
- **Option 2: Via the Tuner4TRONIC® software**  
Selected dimming mode: “AstroDIM (DALI)” or “AstroDIM PD (DALI)”

For option 1, the AstroDIM feature is activated without the need for programming. Only a permanent connection between the L and the SD(2) port of the LED driver is necessary (see figure 21). If the SD(2) port is not active during the start-up phase of the LED driver (for 1 s), the StepDIM feature is activated instead of the AstroDIM feature. Information on the default dimming profile can be found in the datasheet of the applied LED driver.

For option 2, the external wiring can be avoided if either the “AstroDIM (DALI)” or “AstroDIM PD (DALI)” dimming mode is selected via the software (see figure 22).

**Figure 21: Wiring: StepDIM/AstroDIM/DALI (wiring selection)**

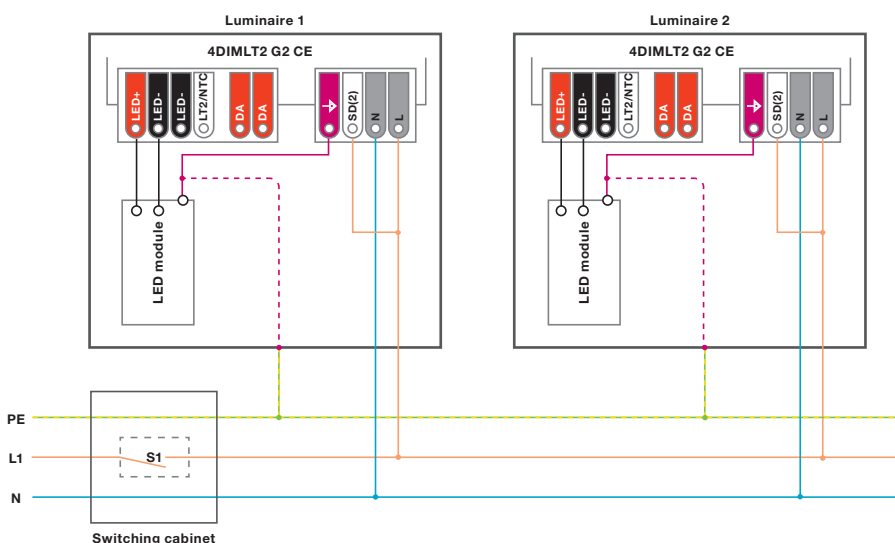
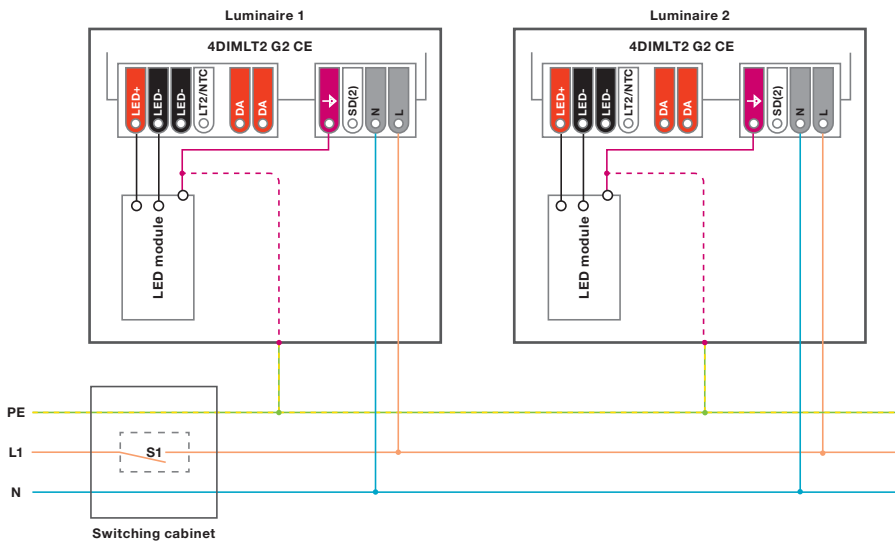

Figure 22: Wiring: AstroDIM (DALI) or AstroDIM PD (DALI)



### 3.2.2 Time-based mode

In this mode, the LED driver performs the dimming profile defined in the reference schedule based on the switch-on time of the unit. Five independent output levels can be set for each step. The minimum length of one dimming period has to be longer than the AstroDIM fade time.

The maximum duration of the schedule is 23 h and 59 min. If less than five output levels need to be performed, two sequenced levels have to be set to the same value. The AstroDIM dimming profile in the time-based mode already starts after the first power-off/on cycle after programming.

Figure 23: Time-based AstroDIM

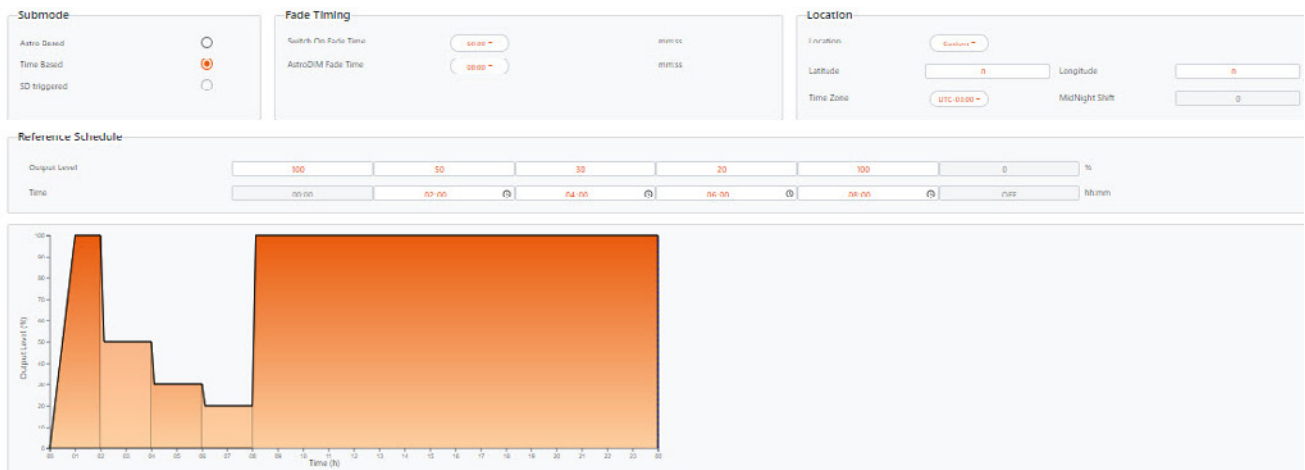

Fade timing:

- **AstroDIM fade time:** Fade time between the different dimming levels.
- **Switch-on fade time:** Fade time after the power-on of the LED driver. The output level at the end of this fade time is defined by the output level of the corresponding dimming period.

Table 6: Fade timing parameters (time-based mode)

Parameter	Min.	Max.	Default
AstroDIM fade time	0, 2 s	8 min	3 min
Switch-on fade time	0, 15 s	60 min	0 s

### 3.2.3 Astro-based mode

In this mode, the LED driver performs a dimming profile based on the daily power-on and power-off times. The dimming schedule is adapted according to the length of the night.

The Tuner4TRONIC® software calculates the annual average middle of the night based on the theoretical sunrise and sunset times, which are related to the location selected in the software. Based on this average middle of the night,

five independent dimming periods can be defined in the reference schedule. The minimum length of one dimming period has to be longer than the AstroDIM fade time. Valid time values can be set between 12:00 pm and 11:59 am. If less than five output levels need to be performed, two sequenced levels have to be set to the same value.

The defined dimming profile is already performed after the second power-off/on cycle after programming.

Figure 24: Astro-based AstroDIM



Fade timing:

- **AstroDIM fade time:** Fade time between the different dimming levels.

To achieve further energy savings in the twilight phase, the switch-on and switch-off fade time can be set to up to 60 minutes.

- **Switch-on fade time:** Fade time after the LED driver has been powered on. The output level at the end of this fade time is defined by the output level of the related dimming period (step x).
- **Switch-off fade time:** Fade time prior to the estimated power-off point. The switch-off fading is performed down to the minimum dimming current until the LED driver is switched off externally.

Table 7: Fade timing parameters (astro-based mode)

Parameter	Min.	Max.	Default
AstroDIM fade time	0, 2 s	8 min	3 min
Switch-on fade time	0, 15 s	60 min	0 s
Switch-off fade time	OFF, 0 s	60 min	OFF

**Figure 25: Use cases of AstroDIM mode**

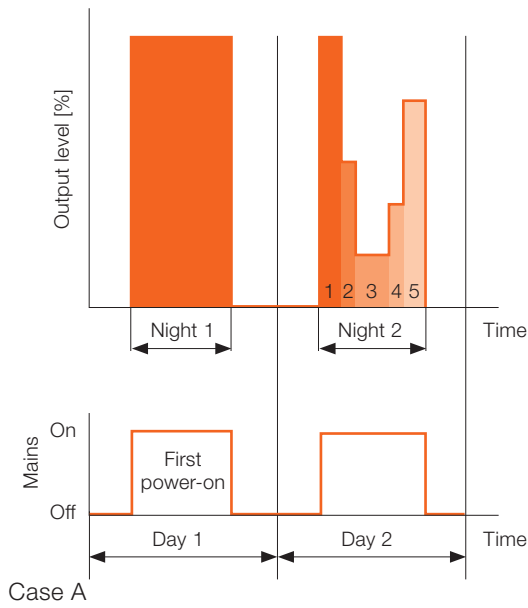

The AstroDIM profile is performed after the first valid on-time.

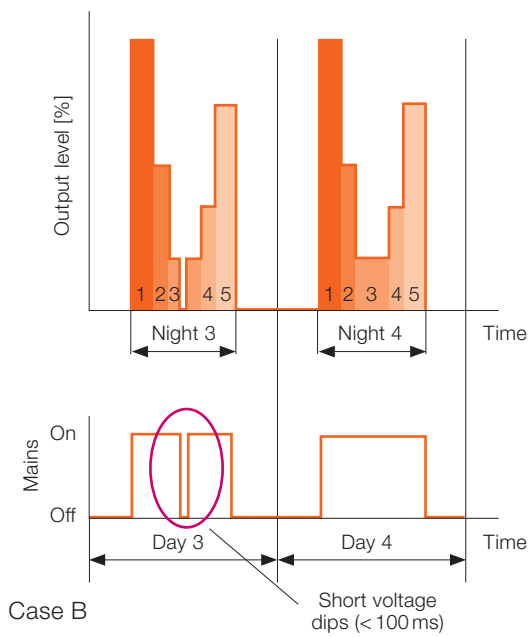

Voltage dips of less than 100 ms do not affect the on-time (case B).

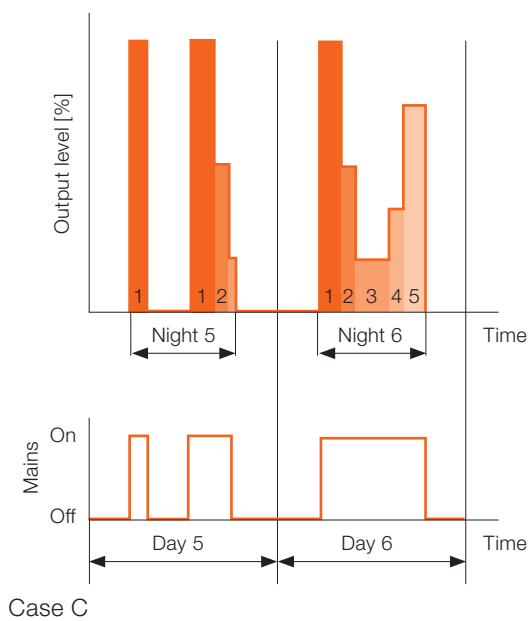

If the on-time of the LED driver is shorter than 4 hours, it is not saved and therefore not used to calculate the next on-time (case C).

**Without switch-off fade time:**

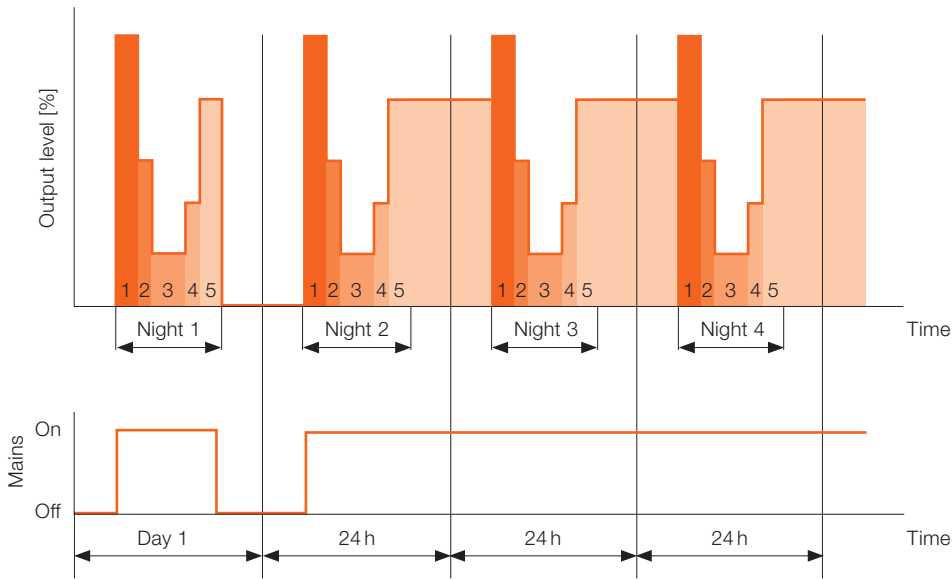

Case D

**With enabled switch-off fade time:**

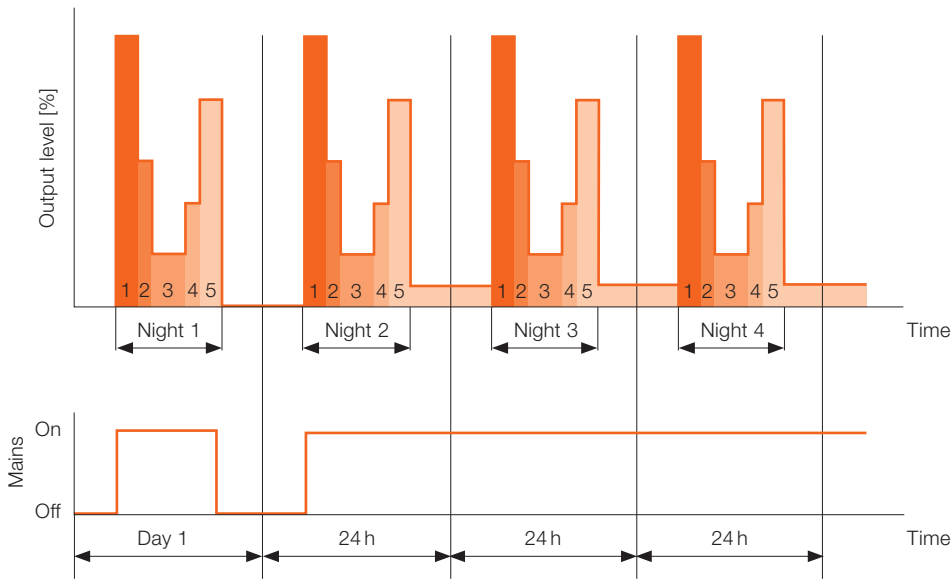

Case E

If the on-time of the LED driver is longer than 24 hours, it is not saved and therefore not used to calculate the next on-time.

**Note:**

If the 4DIMLT2 G2 CE LED driver is operated longer than 24 hours, it cannot be assumed that the different dimming level will start at the same time, because the time base is affected by the accuracy of the mains frequency over the day, week, month and year.

### 3.2.4 Presence detection in AstroDIM mode

In the “AstroDIM PD (DALI)” dimming mode, it is possible to override the dimming profile of AstroDIM with the presence detection settings triggered by an external sensor (e.g. motion or presence sensor) that is connected to the SD(2) port. The sensor must support the electrical characteristics of the SD(2) port.

**Figure 26: AstroDIM wiring with presence detector**

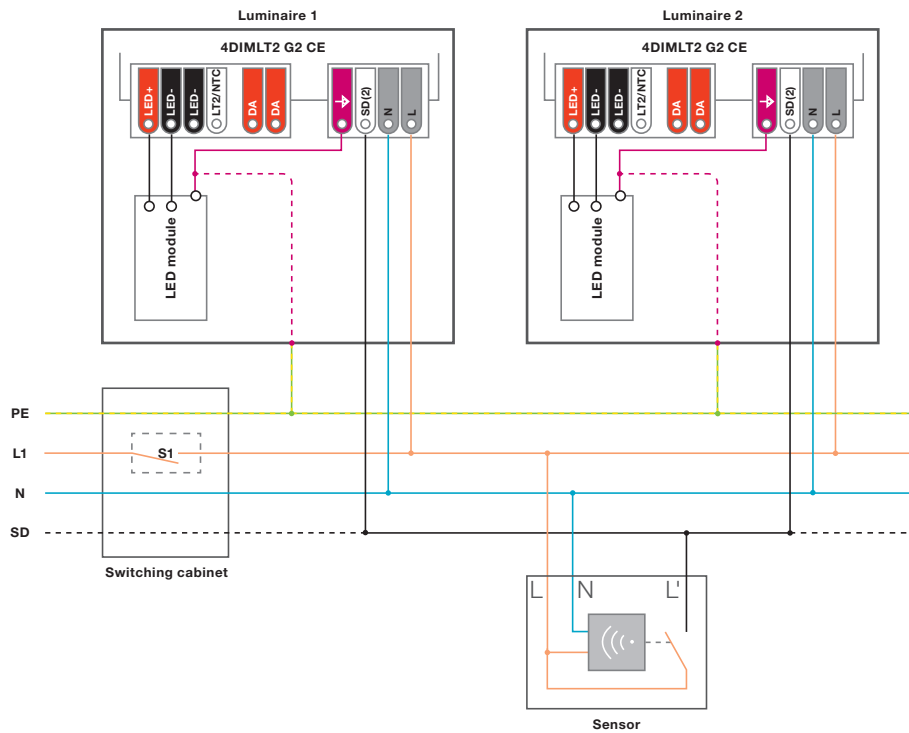

**Figure 27: Presence detection in AstroDIM mode**

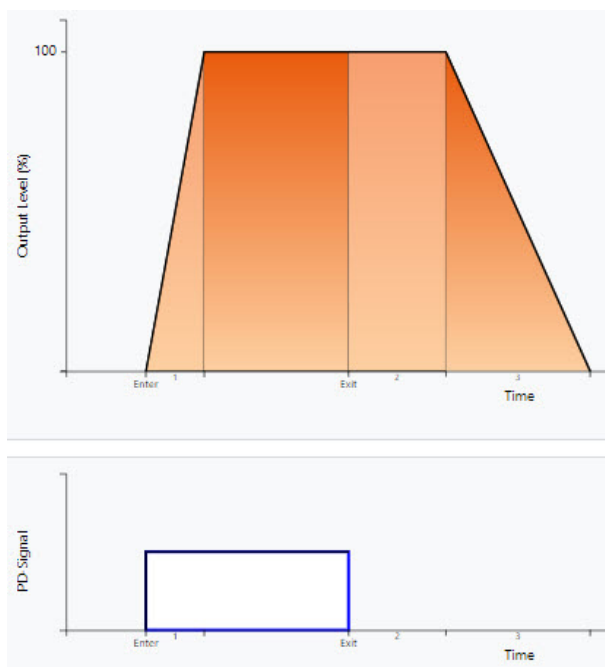

An active signal at the SD(2) port (PD signal) starts the presence detection profile, which is defined by the following four parameters:

- **PD level:** Output level when the SD(2) port is active.
- **Start fade time:** Fade time after the SD(2) port has become active.
- **Hold time:** Hold time after the SD(2) port is not active anymore.
- **End fade time:** Fade time after the hold period.

These parameters can be set using the Tuner4TRONIC® software as shown in figure 28.

**Figure 28: Presence detection configuration**

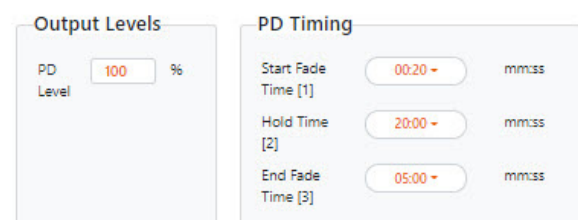

### 3.2.5 AstroDIM SD-triggered

In the “AstroDIM SD-triggered” dimming mode, it is possible to activate the dimming profile of AstroDIM with an active signal at the SD(2) port. Compared to the usual AstroDIM mode, where the dimming profile starts by switching on the LED driver, in the “AstroDIM SD-triggered” mode, the LED driver can be switched on and set to a defined output level until the trigger signal starts the dimming profile.

To activate this feature, select operating mode “AstroDIM + Presence Detection (DALI)” and, within the feature, choose submode “SD-triggered”.

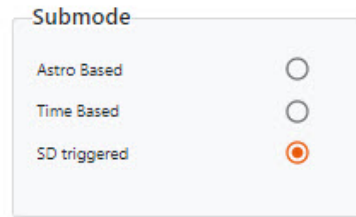

Figure 30 shows the dimming profile according to the reference schedule. The start of the dimming behavior is triggered by the SD signal and can be changed in the reference schedule table.

Figure 29: AstroDIM wiring StepDIM-triggered

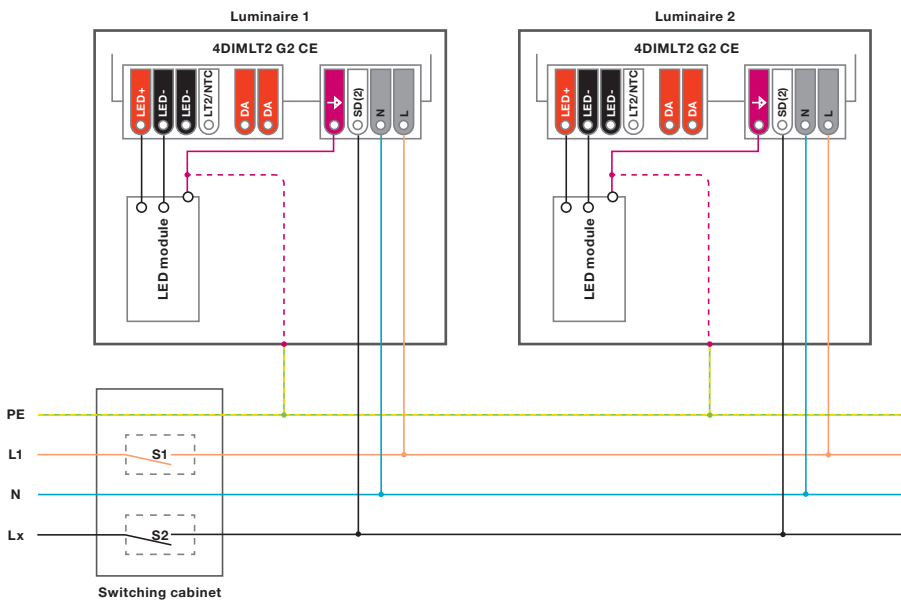
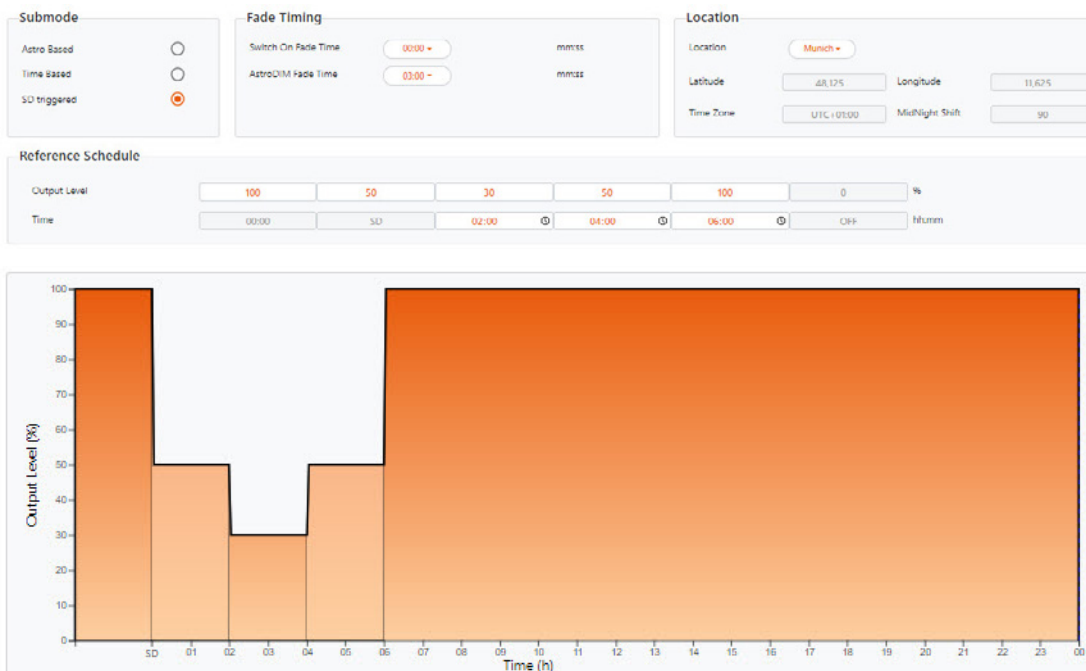

Figure 30: Dimming profile



**Table 8: Presence detection parameters**

Parameter	Min.	Max.	Default
PD level	OFF, 10 %	100 %	100 %
Start fade time	0, 2 s	8 min	OFF
Hold time	0, 15 s	60 min	OFF
End fade time	0, 2 s	8 min	4 s

**Warning:**

If the output level falls below the minimum physical dimming level, the minimum physical dimming level is used by the LED driver. The software still displays the original value. If the output level falls below the minimum allowed dimming current, the value is visualized in red.

**3.3 StepDIM feature**

StepDIM is a one-step dimming mode using an additional control line or a switched phase (pilot line) to control one or more light points and set the light output to a preprogrammed light level. The SD level and the fade time can be set using the Tuner4TRONIC® software.

There are three different StepDIM operating modes:

- StepDIM (DALI)
- StepDIM inverse (DALI)
- StepDIM inverse, autodetect (DALI)

For StepDIM operation, the LED driver is connected to the mains and a control line or a switched phase. Figure 31 shows the connection for the two different supply voltage systems.

**Figure 31: StepDIM wiring**

For 220-240 V<sub>AC</sub> supply system:

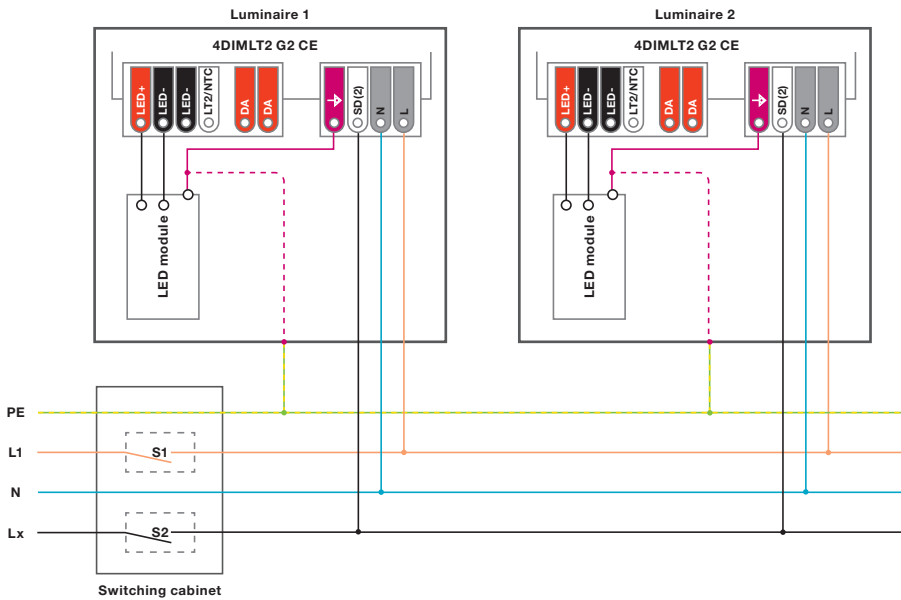



The StepDIM application is supported by the following supply systems:

**Table 9: SD(2) port usage in different supply systems**

Supply system	Nominal voltage	OT 20/170-240/1A0 4DIMLT2 G2 CE	OT 40/170-240/1A0 4DIMLT2 G2 CE	OT 75/170-240/1A0 4DIMLT2 G2 CE	OT 110/170-240/1A0 4DIMLT2 G2 CE	OT 165/170-240/1A0 4DIMLT2 G2 CE
Single-phase	170 V <sub>AC</sub> , 60 Hz	-	-	-	-	-
	220–240 V <sub>AC</sub> , 50/60 Hz	■	■	■	■	■
	240 V <sub>AC</sub> , 60 Hz	■	-	-	-	-
Three-phase	170 V <sub>AC</sub> , 60 Hz	-	-	-	-	-
	220–240 V <sub>AC</sub> , 50/60 Hz	■	■	■	■	■
	240 V <sub>AC</sub> , 60 Hz	-	-	-	-	-

- Not supported  
 ■ Supported

The StepDIM port (SD(2)) of the 4DIMLT2 G2 CE LED driver is triggered by an input current referenced to the neutral (N) and, if the signal is stable for more than 500 ms, the SD(2) port fulfills the following electrical characteristics:

**Table 10: Electrical characteristics of the StepDIM port (SD(2))**

StepDIM signal	Input current SD(2) port	Input voltage SD(2) port (SD(2)-N)
Active (high)	> 2.0 mA <sub>peak</sub>	or > 196 V <sub>AC</sub>
Inactive (low)	< 0.5 mA <sub>peak</sub>	-

In some installations, leakage currents might occur between the different phases due to old or damaged cables, which have insufficient insulation or high-capacitance coupling. The unit can be triggered if the leakage currents exceed the inactive SD(2) input current. False triggering can be avoided by connecting the SD(2) input to the neutral or using a bypass capacitance/resistance between SD(2) and N.

**3.3.1 StepDIM**

If, in the “StepDIM (DALI)” mode, the switch (S2) is closed and the phase voltage Lx is applied to the SD(2) port (SD active), the output level is set to the SD(2) level. Leaving the SD(2) port floating (SD inactive), the output level is set to the nominal level.

**Figure 32: StepDIM behavior**

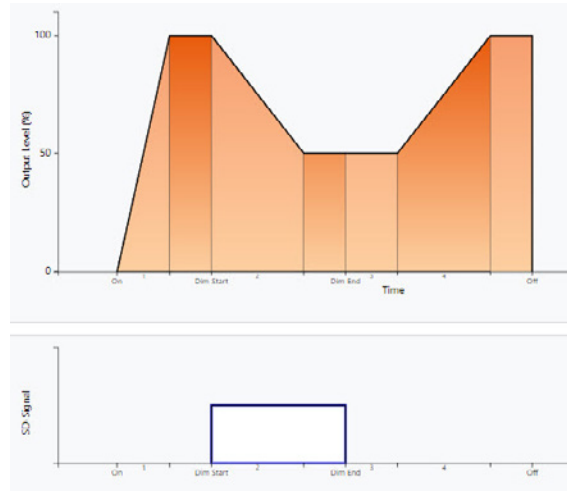

- **Nominal level:** Output level when the SD(2) port is not active.
- **SD level:** Output level when the SD(2) port is active.
- **Switch-on fade time:** Fade time after power-on.
- **Start fade time:** Fade time after the SD(2) port has become active.
- **Hold time:** Hold time after the SD(2) port is not active anymore.
- **End fade time:** Fade time after the hold period.

These parameters can be set using the Tuner4TRONIC® software as shown in figure 33.

**Figure 33: StepDIM configuration**

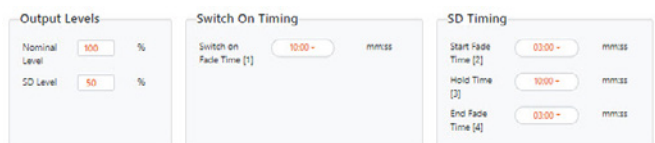

**Table 11: StepDIM parameters**

Parameter	Min.	Max.	Default
Nominal level	OFF, 10 %	100 %	100 %
SD level	OFF, 10 %	100 %	50 %
Switch-on fade time	0, 15 s	60 min	0 s
Start fade time	0, 2 s	8 min	3 min
Hold time	0, 15 s	60 min	OFF
End fade time	0, 2 s	8 min	3 min

**Warning:**

If the output level falls below the minimum physical dimming level, the minimum physical dimming level is used by the LED driver. The software still displays the original value. If the output level falls below the minimum allowed dimming current, the value is visualized in red.

### 3.3.2 StepDIM inverse

For the “StepDIM inverse (DALI)” mode, the behavior is inverted. If the switch (S2) is opened and the SD(2) port is floating (SD inactive), the output level is set to the SD level. If a phase voltage is applied to the SD(2) port (SD active), the output level is set to the nominal level.

Figure 34: “StepDIM inverse” behavior

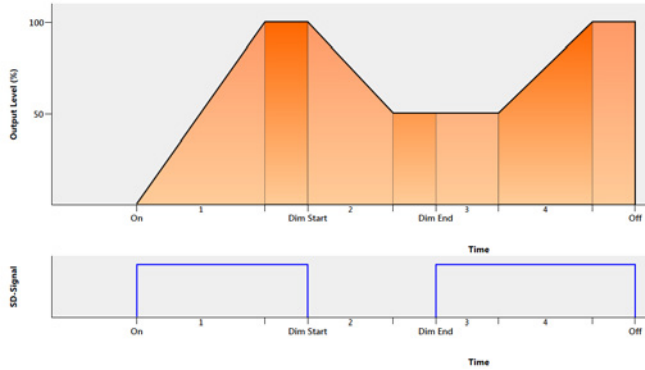

- **Nominal level:** Output level when the SD(2) port is active.
- **SD level:** Output level when the SD(2) port is not active.
- **Switch-on fade time:** Fade time after power-on.
- **Start fade time:** Fade time after the SD(2) port is not active anymore.
- **Hold time:** Hold time after the SD(2) port has become active.
- **End fade time:** Fade time after the hold period.

### 3.3.3 Autodetect, ON/OFF-StepDIM inverse

In the “Autodetect, ON/OFF-StepDIM inverse (DALI)” mode, the LED driver automatically detects if it is used in a simple on/off environment or in a StepDIM inverse installation. If a valid “high” signal (SD active) is detected at the SD(2) port for longer than 20 minutes, the LED driver automatically switches to the “StepDIM inverse” mode. In order to be able to test the correct wiring of the luminaire during the production phase, the first “high” signal at the SD terminal will reduce the light output level to the StepDIM dimming level without changing the driver to the “StepDIM inverse” operating mode.

Figure 35: “Autodetect, ON/OFF-StepDIM inverse” behavior

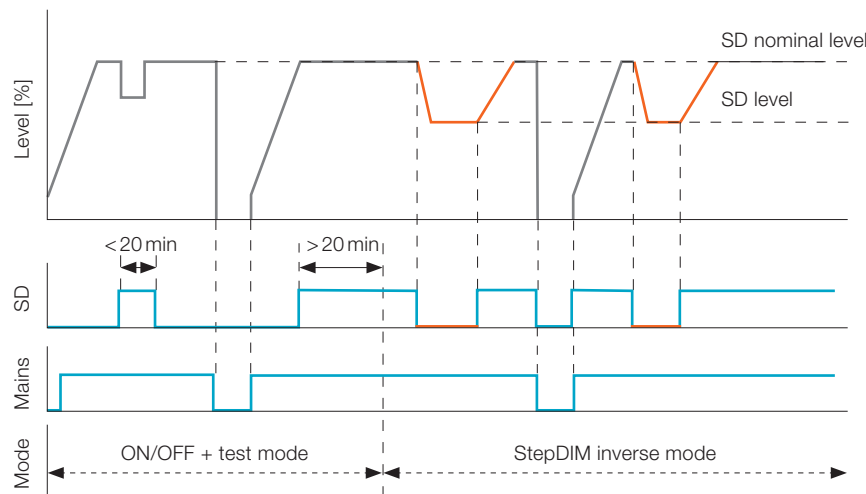

This feature allows minimizing the number of different luminaire configurations and keeps the stock lean.

**Example:**

In some parts of StepDIM installations (e.g. roundabouts or pedestrian crossings), the light output of the installed fixtures should not be reduced during the night. With the “autodetect” feature, all LED drivers can be programmed with the same settings: While the on/off fixtures (SD(2) port not connected) still provide the full light output, the others perform the requested dimming profile.

**3.3.4 Autodetect, AstroDIM-StepDIM inverse**

In the “Autodetect, AstroDIM-StepDIM inverse (DALI)” mode, the LED driver automatically detects if it is used in an AstroDIM environment or in a StepDIM inverse installation. If a valid “high” signal (SD active) is detected at the SD(2) port for longer than 20 minutes, the LED driver automatically switches to the “StepDIM inverse” mode.

**Example:**

The most common usage in outdoor applications is either StepDIM or AstroDIM. With the “Autodetect AstroDIM-StepDIM inverse” mode, all LED drivers can be programmed with the same settings: While the AstroDIM fixtures (SD(2) port not connected) still provide the individual AstroDIM profile, the others perform the requested dimming behavior via StepDIM.

**Figure 36: “Autodetect, AstroDIM-StepDIM inverse” behavior**

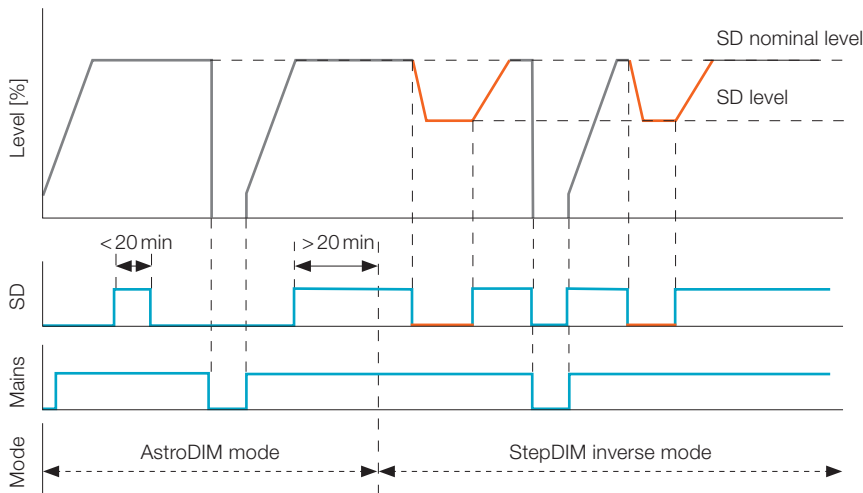

### 3.4 MainsDIM feature

The reduction of the mains amplitude is partly used for the dimming of conventional lamps. In the MainsDIM operating mode, the output current of the LED driver depends on the mains input voltage. Standard electronic drivers compensate for fluctuations in the input voltage and do not support this function. No additional control wires are needed in this dimming mode (see figure 37).

Figure 37: MainsDIM wiring

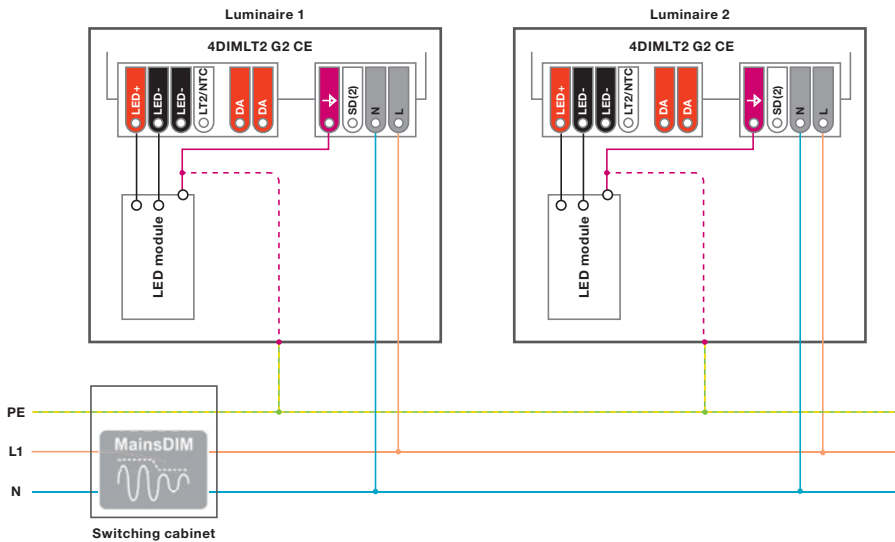

The dimming behavior of the LED driver can be programmed using the Tuner4TRONIC® software. The programmable values can be found in table 12.

Table 12: MainsDIM parameters

Parameter	Min.	Max.	Increment	Default
Start voltage	190V	250V	1V	220V
Start level	20 %	100 %	1 %	100 %
Stop voltage	170V	230V	1V	180V
Stop level	20 %	85 %	1 %	30 %
Start-stop voltage	20V	-	-	-

#### Warning:

If the output level falls below the minimum physical dimming level, the minimum physical dimming level is used by the LED driver. The software still displays the original value. If the output level falls below the minimum allowed dimming current, the value is visualized in red.

**Figure 38: MainsDIM sample programming**

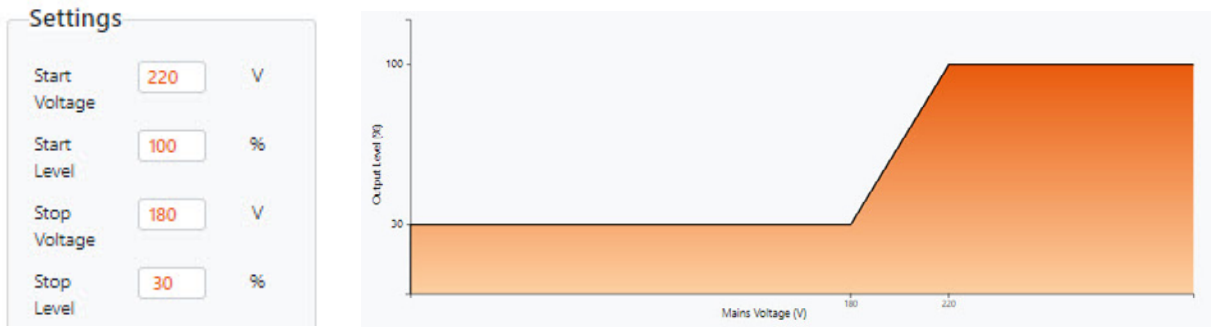

**Note:**

To increase the light output stability against small voltage fluctuations, a minimum voltage difference of 5V from the “start voltage” is necessary to trigger the dimming of the LED driver. The triggering of the dimming is performed with a delay time of approximately 1 to 2 seconds. The setting of the thresholds should also consider the voltage drop in the real installation due to cable and contact resistance.

**3.5 DALI operating mode**

For DALI operation, the 4DIMLT2 G2 CE LED driver is connected to the mains and to a DALI controller or DALI bus (see figure 39). The additional DALI wires can be installed alongside the mains wires.

**Figure 39: DALI wiring**

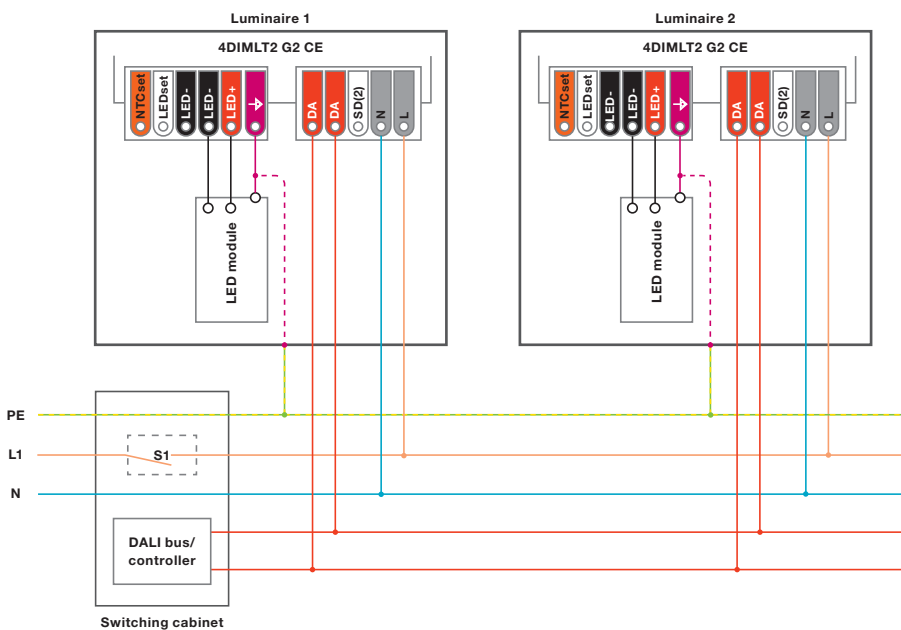

Up to 64 DALI LED drivers can be controlled via a two-wire control line – individually, jointly or in up to 16 groups. All of them are connected in parallel to the two DALI wires. DALI connections are not polarized. Therefore, plus and minus do not have to be checked. The maximum allowed wire length between two DALI LED drivers is 300 m. In case of problems, a DALI repeater has to be used.

The lighting can be switched on/off and dimmed via the DALI control line. A logarithmic (default) or linear dimming curve can be set. Additional status information can be read out and exchanged between the LED driver and the control unit.

The DALI mode always has the highest priority. The LED driver switches to the DALI operating mode as soon as a valid DALI command is received. The DALI mode is maintained until the next power-off/on cycle.

The dimming behavior is set to the logarithmic dimming curve by default.

### 3.5.1 DALI-2



Together with the DALI standard according to IEC 62386 (Edition 2), a manufacturer-independent certification process has been established, again by the Digital Illumination Interface Alliance (DiiA). The product certification by the DiiA ensures a significantly improved interoperability between the different manufacturers. With DALI-2, additional functionalities have been introduced compared to the existing DALI system (version 1) in the market. Moreover, the backwards compatibility to existing systems has been factored in. Only certified DALI-2 products are allowed to carry the DALI-2 certification mark issued by the DiiA.

With DALI-2, the following additional functionalities have been introduced (e.g.):

- Extended fade times (fade time, fade rate)
- Longer serial number and HW identification for improved device recognition
- Queries to identify which DALI functionalities are supported
- Sensors now have a separate address area, therefore all 64 addresses can be used for drivers. In addition, they can also send commands and therefore do not need to be queried continuously by the application control. This improves the payload of the DALI bus.
- ...

DALI-2-compatible drivers also support light control functions defined in DALI version 1.

### Extended OSRAM-specific add-on functionalities

Besides the standardized DALI functions, OSRAM devices also support optional add-on functionalities, which bring additional benefits for certain applications. These functions can be activated on demand with the Tuner4TRONIC® software.

### 3.5.2 Additional functions

Apart from the DALI-2 lighting control functionality, the OT 4DIMLT2 G2 family also supports the new DATA extensions (Parts -251,-252,-253):

#### Data for monitoring and predictive maintenance of luminaires and energy efficiency optimization



LED drivers with this feature offer additional operation and status information (such as energy consumption, power, operating time, overvoltage or undervoltage etc.). By using these data, it is possible to offer predictive maintenance and an overall better lighting service. Moreover, it makes the light management system intelligent. The data can also be visualized in the Tuner4TRONIC® software.

#### Luminaire info with electronic type label



To make light management systems intelligent in terms of service and predictive maintenance, they need basic information about the connected luminaire (model, power, service life etc.). During production, the luminaire manufacturer can store these data in the LED driver, and the light management system can recall these data in the installation.

#### Note:

The 4DIMLT2 family does not support the OSRAM Touch DIM® functionality.

### 3.6 DC operation feature

4DIMLT2 G2 CE LED drivers are prepared for a DC grid operation. As the built-in 4DIMLT2 G2 CE LED driver fuse is not rated for DC operation, an external rated DC fuse has to be installed in front of the driver. The output current in DC operation can be set via the Tuner4TRONIC® software.

Most OSRAM LED drivers are compatible with emergency components from leading emergency lighting companies.

For detailed information on DC operation of our drivers and certificates of compatible components, please consider our “Application notes for DC operation”, which can be found in our OEM Download Center via the following link:

<https://www.osram.com/ds/dc/index.jsp>

**Figure 40: DC wiring**

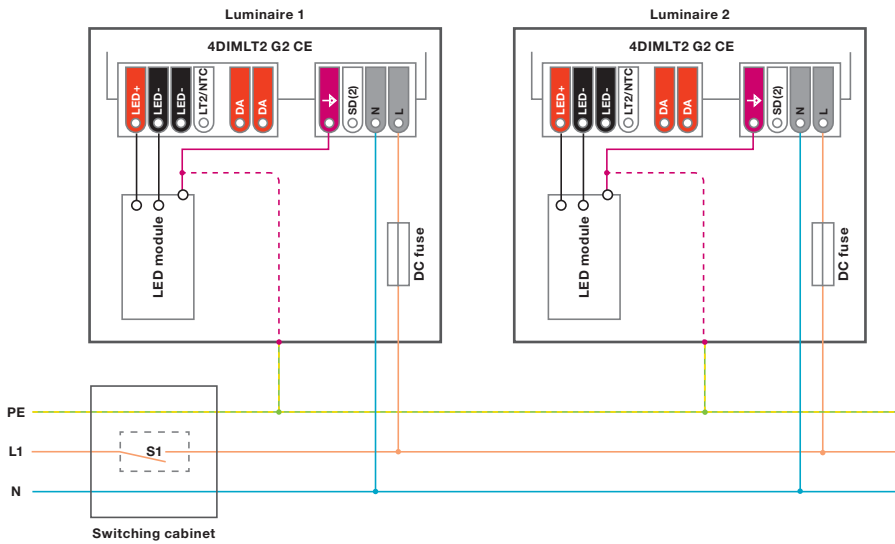











# 4 Additional information

## 4.1 Insulation

4DIMLT2 G2 CE LED drivers have a double/reinforced insulation between the primary and the secondary side and a double/reinforced insulation between all electronic parts and the casing.

**Table 13: Insulation and U<sub>out</sub>**

	OT 20/170- 240/1A0 4DIMLT2 G2 CE	OT 40/170- 240/1A0 4DIMLT2 G2 CE	OT 75/170- 240/1A0 4DIMLT2 G2 CE	OT 110/170- 240/1A0 4DIMLT2 G2 CE	OT 165/170- 240/1A0 4DIMLT2 G2 CE
Insulation (primary/secondary)	 SELV	 SELV	 SELV	 Double	 Double
Insulation of casing	 Double	 Double	 Double	 Double	 Double
U <sub>out</sub>	60V	60V	120V	250V	250V

The equipotential pin (EQUI) meets the requirements for double insulation versus the primary side and requirements for basic insulation versus the secondary side (it complies with the requirements of IEC 60598-1 Annex A – “safe to be touched” – in case of insulation fault between all secondary circuits and accessible conductive parts).

The detailed insulation levels are defined in the instruction sheet of the product.

## 4.2 Cable preparation

4DIMLT2 G2 CE LED drivers use open terminals for easy and quick wiring. To ensure a safe and stable hold of the wires, the insulation of the cables should be stripped accordingly. Solid and flexible wires can be used.

### Primary side:

**Figure 41: Cable preparation, primary side**

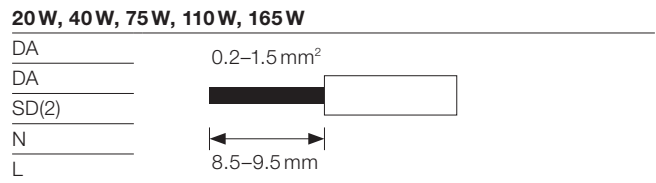

**Figure 42: Cable preparation, secondary side and equipotential pin**

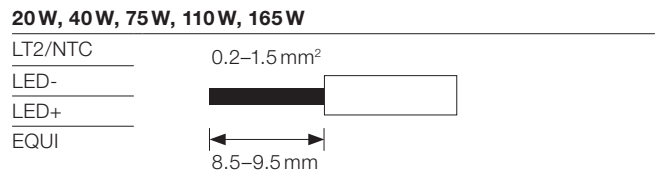



### 4.3 Incorrect wiring on the output side

4DIMLT2 G2 CE LED drivers are inherently protected against incorrect wiring on the output side. Incorrect wiring between LED+ and LEDset or NTCset can irreversibly damage the LED driver. If there is a short circuit between LED+ and LED-, the LED driver shuts down and tries to switch the load back on. The same behavior might occur if the output voltage falls below the minimum allowed voltage.

### 4.4 Input overvoltage

The driver withstands an input voltage of up to 305 V<sub>AC</sub> for an unlimited time but a shutdown of the output load might occur in case the supply voltage exceeds 270 V<sub>AC</sub>. In case of miswiring, the driver can withstand up to 350 V<sub>AC</sub> for no longer than two hours. Under operation conditions in which overvoltage levels >264 V<sub>AC</sub> occur, the product needs to be additionally protected by an external fuse (400V 4 A, time lag, I2 t > 160 A2 sec).

### 4.5 Surge protection

4DIMLT2 G2 CE LED drivers offer a common mode protection level of up to 10kV with an integrated overvoltage suppression for the connected LED module, which minimizes the stress on the LED module and thus ensures high reliability in the field. To achieve the surge protection levels, the EQUI pin needs to be connected to the heat sink of the LED module (see figures 45 and 46). The EQUI pin meets the insulation requirements for protection class I and II luminaires. The protection level between L and N or SD(2) and N is 6kV.

In addition, the SD port contains an active surge suppression element referenced to N. In case an external overvoltage protection device (SPD) is used to protect the DALI port and the mains input, the protection level U<sub>P</sub> of the SPD between DALI port to earth and mains input to earth should be equal. Connecting only an external SPD to the DALI port with a connection to earth is not allowed.

The following protection levels can be achieved for class I and II luminaires:

**Table 14: 4DIMLT2 G2 CE surge protection levels**

Surge between	Test condition acc. to EN 61547
L-N	6kV at 2-Ω source
SD(2)-N	6kV at 2-Ω source
L-EQUI/SD(2)-EQUI/N-EQUI	8kV at 12-Ω source

Surge between	Test condition acc. to EN 61000-4-5
L-EQUI/SD(2)-EQUI/N-EQUI	10kV at 12-Ω source

If an additional external surge protection device is used, please contact your OSRAM sales contact for support.

**Figure 43: Protection class I luminaire**

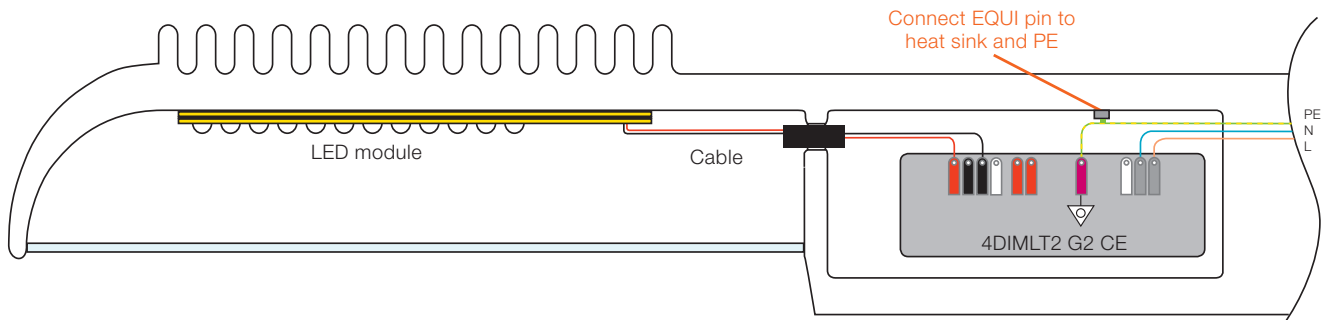

**Figure 44: Protection class II luminaire**

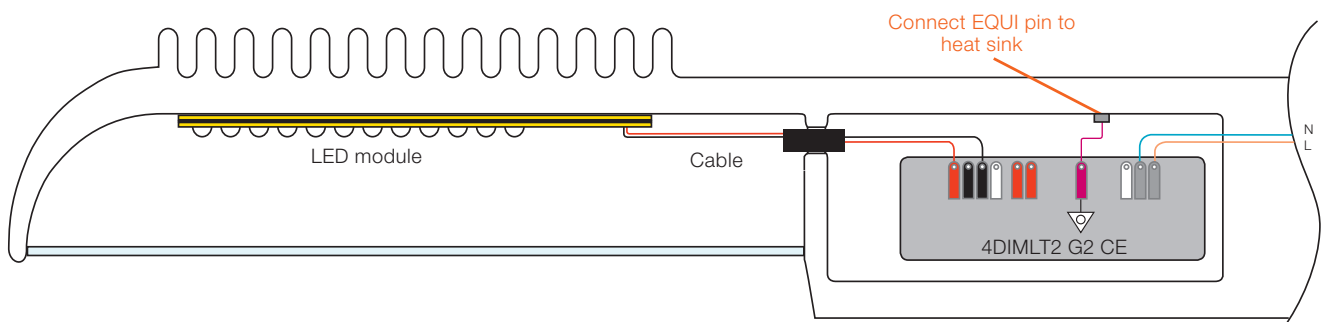

# 5 Programming

4DIMLT2 G2 CE LED drivers can be programmed using Tuner4TRONIC® either via DALI or NFC. Please find details on the Tuner4TRONIC® tool chain, user manuals, application guides, tutorials and download links on <https://www.osram.com/ds/tools/tuner4tronic.jsp>

**Note:**

Performance check: If electronically controlled control gears are combined with electrical power supplies, the electronic circuits of both devices might influence each other. This could lead to wrong measurements (e.g. lower power factor).

### 5.1 Programming with DALI magic

4DIMLT2 G2 CE LED drivers need to be powered during programming with DALI magic – either with mains input voltage (case A) or with SELV DC voltage (case B). Programming at SELV DC voltage allows safe programming without the need for additional safety precautions during production.

**Figure 45: LED driver programming with DALI magic**

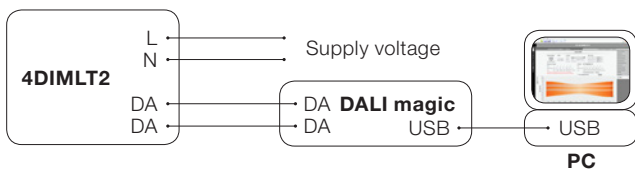

**Warning:**

In case of partial programming, the SELV DC voltage (case B) needs to be applied to the LED driver for at least 4 seconds.

**Table 15: Supply voltage during programming**

Case	Supply voltage	Power	Ambient temperature
A	220–240 V <sub>AC</sub>	20, 40, 75 and 110W	Acc. to LED driver datasheet
B	48V <sub>DC</sub> +15%/-4% <sup>1), 2)</sup>	20, 40, 75 and 110W	-10°C to +40°C

- 1) The power supply should be capable to deliver an average current of 100 mA and contain an automatic restart function in case of overload (typ. peak inrush current of 1 A).
- 2) The 48V<sub>DC</sub> programming is not applicable for 3DIMLT(+) LED drivers.

### 5.2 Programming with NFC USB readers

4DIMLT2 G2 CE LED drivers must not be powered during programming with T4T-Production via NFC. Place the LED driver on the NFC reader and align the antennas of both devices. The position of the NFC antenna is indicated by the NFC logo on the label of the LED driver and is mounted vertically at the side of the driver's housing. When using box programming, the NFC logo on the box needs to be placed in the center of the FEIG Antenna ANT310/310. Please find a list of supported NFC readers in the T4T-Production user manual.

**Figure 46: LED driver programming with NFC**

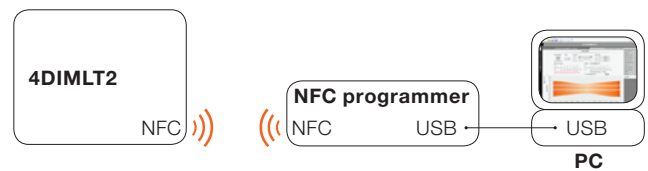

**Note:**

A power-off/on cycle is necessary to activate the password settings in ConfigLock

### 5.3 Programming with T4T-Field App

4DIMLT2 G2 CE LED drivers can be programmed via NFC with the Tuner4TRONIC® Field app available for download to Android and iOS mobile devices from GooglePlay and AppStore. T4T-Field App allows reading driver data, programming drivers from production files and editing data such as light output, CLO, dimming profiles and luminaire info data. Reading and writing data with T4T-Field App is possible with and without powering the driver with mains. Programming data may be restricted by password settings from the luminaire manufacturer.

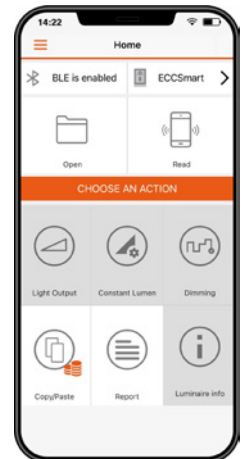

**Disclaimer**

All information contained in this document has been collected, analyzed and verified with great care by OSRAM. However, OSRAM is not responsible for the correctness and completeness of the information contained in this document and OSRAM cannot be made liable for any damage that occurs in connection with the use of and/or reliance on the content of this document. The information contained in this document reflects the current state of knowledge on the date of issue.

Need more support? As a registered customer,  
you can contact our experts by e-mail

[support-ds@osram.com](mailto:support-ds@osram.com)



Not a registered customer?  
Please use our contact form

<https://www.osram.com/apps/cbcontact/contacts/add>



OSRAM GmbH

Headquarters Germany:

Marcel-Breuer-Strasse 6  
80807 Munich, Germany  
Phone +49 89 6213-0  
Fax +49 89 6213-2020  
[www.osram.com](http://www.osram.com)

**OSRAM**