

NINA-W10 series

Stand-alone Multiradio modules

Data sheet



Abstract

This technical data sheet describes the NINA-W10 series stand-alone multiradio MCU module that integrates a powerful microcontroller (MCU) and a radio for wireless communication. The module has a number of important security features embedded, including secure boot, which ensures the module boots up only in the presence of authenticated software.

Document information

Title	NINA-W10 series	
Subtitle	Stand-alone Multiradio modules	
Document type	Data sheet	
Document number	UBX-17065507	
Revision and date	R05	8-Aug-2019
Disclosure Restriction		

Product status	Corresponding content status	
Functional Sample	Draft	For functional testing. Revised and supplementary data will be published later.
In Development / Prototype	Objective Specification	Target values. Revised and supplementary data will be published later.
Engineering Sample	Advance Information	Data based on early testing. Revised and supplementary data will be published later.
Initial Production	Early Production Information	Data from product verification. Revised and supplementary data may be published later.
Mass Production / End of Life	Production Information	Document contains the final product specification.

This document applies to the following products:

Product name	Type number	Hardware version	PCN reference	Product status
NINA-W101	NINA-W101-00B-00	06	N/A	Initial Production
NINA-W102	NINA-W102-00B-00	06	N/A	Initial Production

u-blox or third parties may hold intellectual property rights in the products, names, logos and designs included in this document. Copying, reproduction, modification or disclosure to third parties of this document or any part thereof is only permitted with the express written permission of u-blox.

The information contained herein is provided "as is" and u-blox assumes no liability for its use. No warranty, either express or implied, is given, including but not limited to, with respect to the accuracy, correctness, reliability and fitness for a particular purpose of the information. This document may be revised by u-blox at any time without notice. For the most recent documents, visit www.u-blox.com.

Copyright © u-blox AG.

Contents

Document information	2
Contents	3
1 Functional description	6
1.1 Overview	6
1.2 Applications	6
1.3 Product features	7
1.4 Block diagram	8
1.5 Product variants.....	8
1.5.1 NINA-W101	8
1.5.2 NINA-W102.....	8
1.6 Radio performance	8
1.7 CPU.....	9
1.7.1 Software upgrade	10
1.8 MAC addresses	10
1.9 Power modes.....	10
2 Interfaces	11
2.1 Power supply	11
2.1.1 Module supply input (VCC)	11
2.1.2 Digital I/O interfaces reference voltage (VCC_IO)	11
2.2 Low Power Clock.....	11
2.3 Module reset	11
2.4 Boot strapping pins	11
2.5 RF antenna interface.....	12
2.5.1 Internal antenna.....	12
2.5.2 External RF antenna interface.....	12
2.6 IO signals.....	13
2.6.1 Pulse Width Modulation (PWM)	13
2.7 Data interfaces	13
2.7.1 UARTs	13
2.7.2 RMII.....	13
2.7.3 SPI.....	13
2.7.4 Dual/Quad SPI.....	14
2.7.5 I ² C.....	14
2.7.6 SDIO.....	14
2.7.7 CAN.....	14
2.8 Debug interfaces	14
2.8.1 JTAG debug interfaces	14
2.9 Analog interfaces	14
2.9.1 Analog to digital converters	14
2.9.2 Digital to analog converters	15

3	Pin definition	16
3.1	Pin assignment	16
4	Electrical specifications	19
4.1	Absolute maximum ratings	19
4.1.1	Maximum ESD ratings	19
4.2	Operating conditions	20
4.2.1	Operating temperature range	20
4.2.2	Supply/Power pins	20
4.2.3	RESET_N pin	20
4.2.4	LPO clock	20
4.2.5	Digital pins	21
4.2.6	Current consumption	22
4.2.7	Wi-Fi radio characteristics	23
4.2.8	Bluetooth radio characteristics	23
4.2.9	Bluetooth low energy characteristics	24
5	Mechanical specifications	25
5.1	NINA-W101 Mechanical specification	25
5.2	NINA-W102 Mechanical specification	26
6	Qualification and approvals	27
6.1	Country approvals	27
6.2	European Union regulatory compliance	27
6.2.1	Radio Equipment Directive (RED) 2014/53/EU	27
6.2.2	Compliance with the RoHS directive	27
6.3	FCC/IC Compliance	27
6.3.1	Open CPU responsibility and obligations	27
6.3.2	RF-exposure statement	28
6.3.3	End-product user manual instructions	29
6.3.4	End-product labeling requirements	29
6.3.5	End-product compliance	30
6.4	Japan radio equipment compliance	31
6.5	NCC Taiwan compliance	31
6.5.1	Taiwan NCC Warning Statement	31
6.5.2	NINA-W101 labeling requirements for end product	31
6.5.3	NINA-W102 labeling requirements for end product	31
6.6	KCC South Korea compliance	32
6.7	Brazil compliance	32
6.8	Australia and New Zealand regulatory compliance	32
6.9	South Africa regulatory compliance	33
6.10	Safety Compliance	33
6.11	Bluetooth qualification information	33
7	Antennas	34
7.1	Antenna accessories	35

7.2	Approved antennas	35
7.2.1	Single band antennas	35
7.2.2	Dual-band antennas.....	39
8	Product handling.....	40
8.1	Packaging	40
8.1.1	Reels	40
8.1.2	Tapes.....	40
8.2	Moisture sensitivity levels.....	42
8.3	Reflow soldering	42
8.4	ESD precautions.....	42
9	Labeling and ordering information	43
9.1	Product labeling.....	43
9.2	Explanation of codes	44
9.3	Ordering information.....	44
Appendix	45
A	Glossary	45
Related documents	47
Revision history	47
Contact		48

1 Functional description

1.1 Overview

The NINA-W10 series are stand-alone multiradio MCU modules that integrate a powerful microcontroller (MCU) and a radio for wireless communication. With the open CPU architecture, customers can develop advanced applications running on the dual core 32-bit MCU. The radio provides support for Wi-Fi 802.11b/g/n in the 2.4 GHz ISM band and Bluetooth v4.2 (Bluetooth BR/EDR and Bluetooth low energy) communications.

The NINA-W10 includes the wireless MCU, flash memory, crystal, and components for matching, filtering, antenna and decoupling, making it a very compact stand-alone multiradio module. The module can be used to design solutions with top grade security, thanks to integrated cryptographic hardware accelerators.

Intended applications include telematics, low power sensors, connected factories, connected buildings (appliances and surveillance), point-of-sales, and health devices.

Device design is simplified as developers can choose to either use an external antenna (NINA-W101) or take advantage of the internal antenna (NINA-W102).

NINA-W10 is assessed to comply with RED and is certified as a modular transmitter in the following countries: US (FCC), Canada (IC / ISED RSS), Japan (MIC), Taiwan (NCC), South Korea (KCC), Australia / New Zealand (ACMA), Brazil (Anatel), South Africa (ICASA). The modules will be qualified according to ISO 16750 for professional grade operation, supporting an extended temperature range of -40°C to $+85^{\circ}\text{C}$.

1.2 Applications

- Internet of Things (IoT)
- Wi-Fi networks
- Bluetooth and Bluetooth low energy applications
- Telematics
- Point-of-sales
- Medical and industrial networking
- Access to laptops, mobile phones, and similar consumer devices
- Home/building automation
- Ethernet/Wireless Gateway

1.3 Product features

	NINA-W101	NINA-W102
Grade		
Automotive		
Professional	•	•
Standard		
Radio		
Bluetooth qualification	v4.2	
Bluetooth profiles	S, G, A2, AV, HF, HS	
Bluetooth BR/EDR	•	•
Bluetooth low energy	•	•
Bluetooth output power EIRP [dBm]	8	8
Wi-Fi 2.4 / 5 [GHz]	2.4	2.4
Wi-Fi IEEE 802.11 standards	b/g/n	b/g/n
Wi-Fi output power EIRP [dBm]	18	18
Max Wi-Fi range [meters]	500	400
Antenna type	p	i
Application software		
Open CPU for embedded customer applications	•	•
Interfaces		
UART	◆	◆
SPI	◆	◆
I ² C	◆	◆
I ² S	◆	◆
RMII	◆	◆
GPIO pins	20	20
AD converters (ADC)	◆	◆
Features		
Point-to-Point Protocol	◆	◆
Extended Data Mode	◆	◆
Low Energy Serial Port Service	◆	◆
Wi-Fi throughput [Mbit/s]	100	100
Maximum Bluetooth connections	8	8
Micro Access Point [max stations]	4	4
Wi-Fi enterprise security	◆	◆
Secure boot	◆	◆
WPA/WPA2	◆	◆

S = SPP A2 = A2DP p = Antenna pin ◆ = Feature enabled by HW.
 G = GATT AV = AVRCP i = Internal antenna The actual support depends on the open CPU application SW.
 HF = HFP
 HS = HSP

Table 1: NINA-W10 series main features summary

1.4 Block diagram

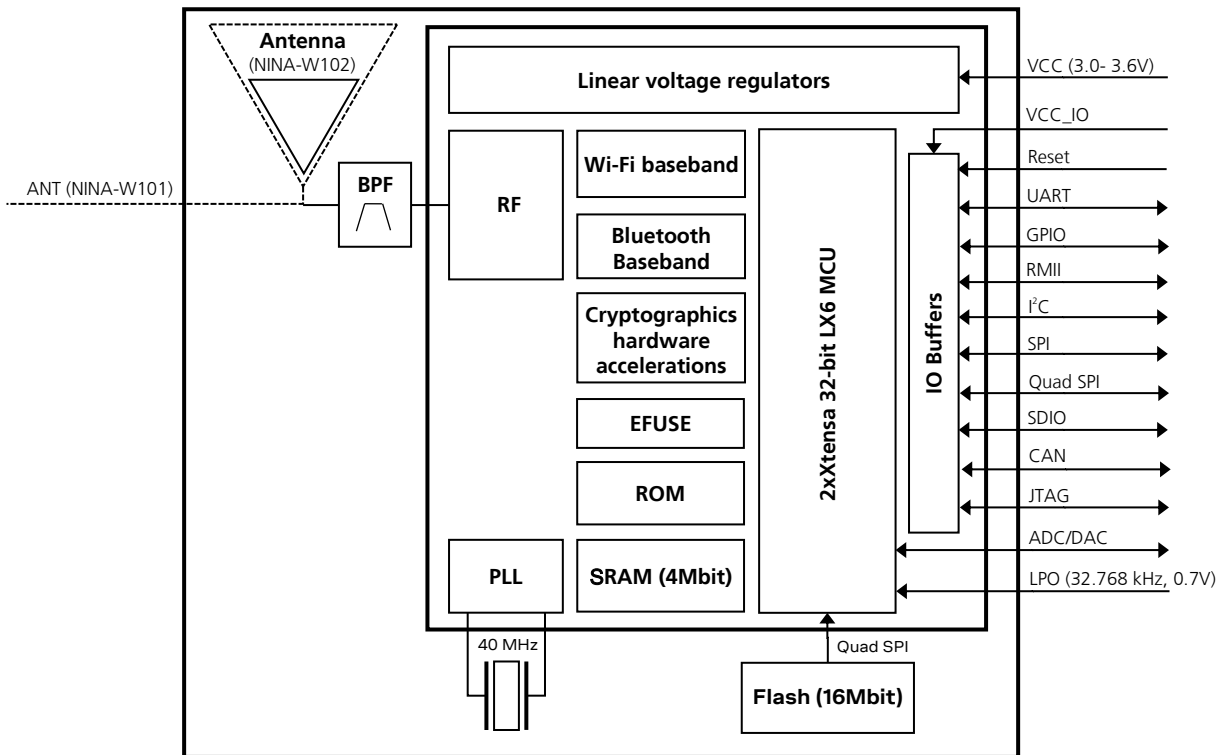


Figure 1: Block diagram of NINA-W10 series

1.5 Product variants

The NINA-W10 modules have open CPU architecture tailored for OEMs who wish to embed their own application on top of the available Wi-Fi functionality including support for Bluetooth and Bluetooth low energy.

1.5.1 NINA-W101

The NINA-W101 modules do not use the internal antenna and thus the PCB outline has been trimmed to 10.0 x 10.6 mm. Instead of an internal antenna, the RF signal is available at a module pin for routing to an external antenna or antenna connector.

1.5.2 NINA-W102

The NINA-W102 modules use an integrated antenna mounted on the PCB. The PCB outline is 10.0 x 14.0 mm. The RF signal pin is not connected to any signal path.

1.6 Radio performance

The NINA-W10 series (NINA-W101 and NINA-W102) modules support Wi-Fi and conform to IEEE 802.11b/g/n single-band 2.4 GHz operation, Bluetooth BR/EDR, and Bluetooth low energy as explained in Table 2.

Wi-Fi	Bluetooth BR/EDR	Bluetooth Low Energy
IEEE 802.11b/g/n	Bluetooth v4.2 + EDR Maximum number of slaves: 7	Bluetooth 4.2 BLE dual-mode
Band support 2.4 GHz, channel 1-13*	Band support 2.4 GHz, 79 channels	Band support 2.4 GHz, 40 channels
Typical conducted output power 15 dBm	Typical conducted output power - 1 Mbit/s: 5 dBm - 2/3 Mbit/s: 5 dBm	Typical conducted output power 5 dBm
Typical radiated output power 18 dBm EIRP**	Typical radiated output power - 1 Mbit/s: 8 dBm EIRP** - 2/3 Mbit/s: 8 dBm EIRP**	Typical radiated output power 8 dBm EIRP**
Conducted sensitivity -96 dBm	Conducted sensitivity -88 dBm	Conducted sensitivity -88 dBm
Data rates: IEEE 802.11b: 1 / 2 / 5.5 / 11 Mbit/s IEEE 802.11g: 6 / 9 / 12 / 18 / 24 / 36 / 48 / 54 Mbit/s IEEE 802.11n: MCS 0-7, HT20 (6.5-72 Mbit/s)	Data rates: 1 / 2 / 3 Mbit/s	Data rates: 1 Mbit/s

* Depending on the location (country or region), channels 12-13 must be limited or disabled; the software implementation must support country determination algorithms for using channel 12-13, for example, with 802.11d. See section 6.1 for more info.

** RF power including maximum antenna gain (3 dBi).

Table 2: NINA-W10 series – Wi-Fi and Bluetooth characteristics

1.7 CPU

The NINA-W10 series has a dual-core system with two Harvard Architecture Xtensa LX6 CPUs with max 240 MHz internal clock frequency. The internal memory of NINA-W1 includes the following:

- 448 Kbyte ROM for booting and core functions
- 520 Kbyte SRAM for data and instruction
- 16 Mbit FLASH for code storage including hardware encryption to protect programs and data
- 1 kbit EFUSE (non-erasable memory) for MAC addresses, module configuration, Flash-Encryption, and Chip-ID

The open CPU variants (NINA-W101/NINA-W102) also support external FLASH and SRAM memory via a Quad SPI interface (see section 2.7.4).

NINA-W10 has no software and provides an open CPU architecture. With the open CPU architecture, customers can develop advanced applications running on the dual core 32-bit MCU. The radio provides support for Wi-Fi 802.11b/g/n in the 2.4 GHz ISM band, Bluetooth BR/EDR, and Bluetooth low energy communication. It is the responsibility of the customer to comply with the NINA-W10 certification and configuration as mentioned in section 6.1.

The module can be used to design solutions with top grade security, thanks to integrated cryptographic hardware accelerators. This enables secure boot, which ensures the module boots up only in the presence of authenticated software.

1.7.1 Software upgrade

Information on how to upgrade the software for NINA-W10 series is provided in the NINA-W1 Series System Integration Manual [1].

1.8 MAC addresses

For information about MAC addresses, see http://esp-idf.readthedocs.io/en/latest/api-reference/system/base_mac_address.html.

1.9 Power modes


The NINA-W10 series modules are power efficient devices capable of operating in different power saving modes and configurations. Different sections of the module can be powered off when not needed and complex wake up events can be generated from different external and internal inputs. For the lowest current consumption modes, an external LPO clock is required (see section 2.2).

See the Espressif ESP32 Datasheet [3] for more information about power modes.

2 Interfaces

2.1 Power supply

The power for NINA-W10 series modules is supplied through **VCC** and **VCC_IO** pins by DC voltage.

-  The system power supply circuit must be able to support peak power (add 20% as margin over the listed type current consumption), as during operation, the current drawn from **VCC** and **VCC_IO** can vary significantly based on the power consumption profile of the Wi-Fi technology.

2.1.1 Module supply input (VCC)

The NINA-W10 series modules use an integrated Linear Voltage converter to transform the supply voltage presented at the **VCC** pin into a stable system voltage.


2.1.2 Digital I/O interfaces reference voltage (VCC_IO)

All modules in the NINA-W10 series provide an additional voltage supply input for setting the I/O voltage level.

The separate **VCC_IO** pin enables integration of the module in many applications with different voltage levels (for example, 1.8 V or 3.3 V) without any level converters. The NINA-W1 modules support only 3.3 V as IO voltage level currently.

2.2 Low Power Clock

The NINA-W10 series module does not have an internal low power oscillator (LPO), which is required for low power modes. An external 32.768 KHz LPO signal can be supplied externally via the **LPO_CLK** pin if low power modes are required.

-  The low power clock voltage level is lower (0/0.7 V) compared to the digital signal levels and a voltage divider might be required (see section 4.2.4).

2.3 Module reset

The NINA-W10 series modules can be reset (rebooted) in with a low level on the **RESET_N** pin, which is normally set high by an internal pull-up. This causes “hardware” reset of the module. The **RESET_N** signal should be driven by an open drain, open collector or contact switch. When **RESET_N** is low (off), the chip works at the minimum power.

2.4 Boot strapping pins

There are several boot configuration pins available on the module that must have the correct settings during boot. It is important that they are in the default state (marked with bold in Table 3) during startup for normal operation. The default state is automatically selected (with internal pull-ups or pull-downs) if the pins are left unconnected.

Pin	State during boot	Default	Behavior	Description
36	0		VDD_SDIO=3.3V	Voltage of Internal Flash
	1	10 kΩ pull-up	VDD_SDIO=1.8V (VDD_SDIO should always be 1.8 V)	
27, 25	00		Download Boot	Booting Mode.
	01		Reserved, do not use	
	10	Pull-up*, Pull-down*	Normal Boot from internal Flash	
	11		Normal Boot from internal Flash	
32	0		Silent	Debugging Log on UOTXD during booting
	1	Pull-up*	UOTXD Toggling	
32, 28	00		Falling-edge input, falling-edge output	Timing of SDIO Slave
	01		Falling-edge input, rising-edge output	
	10		Rising-edge input, falling-edge output	
	11	Pull-up*, Pull-up*	Rising-edge input, rising-edge output	

* About 30 kΩ

Table 3: NINA-W10 series boot strapping pins

2.5 RF antenna interface

The RF antenna interface of the NINA-W10 series supports Bluetooth BR/EDR and Bluetooth low energy on the same RF antenna signal (the signal is switched between Bluetooth and Wi-Fi as the different RF technologies are never active simultaneously). The module is equipped with a 2.4 GHz bandpass filter between the radio chip and RF antenna interface (see section 1.4).

The NINA-W10 series supports either an internal antenna (NINA-W102) or external antennas connected through an antenna pin (NINA-W101).


2.5.1 Internal antenna

The NINA-W102 module has an internal (embedded) 2.4 GHz PIFA antenna. The internal antenna is a PIFA antenna specifically designed and optimized for the NINA form factor.

Keep a minimum clearance of 5 mm between the antenna and the casing. Keep a minimum of 10 mm free space from the metal around the antenna including the area below. If a metal enclosure is required, use NINA-W101/ and an external antenna.

It is recommended to place the NINA-W102/ modules in such a way that the internal antenna is in the corner of the host PCB (the corner closest to Pin 16 should be in the corner). The antenna side (short side closest to the antenna), positioned along one side of the host PCB ground plane is the second best option. It is beneficial to have a large solid ground plane on the host PCB and have a good grounding on the NINA-W102/ module. Minimum ground plane size is 24x30 mm but recommended is more than 50x50 mm.

See the NINA-W1 Series System Integration Manual [1] for more information about antenna related design.

 The ANT signal is not available on the solder pins of the NINA-W102 module.

2.5.2 External RF antenna interface

The NINA-W101 module has an antenna signal (**ANT**) pin with a characteristic impedance of 50 Ω for using an external antenna. The antenna signal supports both Tx and Rx.

The external antenna, for example, can be an SMD antenna (or PCB integrated antenna) on the host board. An antenna connector for using an external antenna via a coaxial cable could also be

implemented. A cable antenna might be necessary if the module is mounted in a shielded enclosure such as a metal box or cabinet.

An external antenna connector (U.FL. connector) reference design (see the NINA-W1 Series System Integration Manual [1]) is available and must be followed to comply with the NINA-W1 FCC/IC modular approvals.

Also see the list of approved antennas (section 7.2).

2.6 IO signals

The NINA-W1 module has 36 pins in total, out of which 20 can be used as input and output and 4 signals are only inputs. The pins can be used as GPI(O) but are also multiplexed with the digital and analog interfaces. There are four input only signals (GPI) that can only be input regardless of the selected function/interface.

It is also possible to multiplex all interfaces via an IO MUX to any pin but the speed is limited (see section 4.2.4).

2.6.1 Pulse Width Modulation (PWM)

The Pulse Width Modulation (PWM) functionality, for example, can be used to control the intensity of LEDs and driving digital motors. The controller consists of PWM timers, the PWM operator, and a dedicated capture sub-module. Each timer provides timing in synchronous or independent form, and each PWM operator generates the waveform for one PWM channel.

The PWM controller has 16 channels, which can generate independent waveforms that can be used to drive RGB LED devices. For maximum flexibility, the high-speed as well as the low-speed channels can be driven from one of four high-speed/low-speed timers. The PWM controller also has the ability to automatically increase or decrease the duty cycle gradually, allowing for fades without any processor interference. The PWM signals can be configured to be available on any of the GPIO pins via the IO MUX.

2.7 Data interfaces

2.7.1 UARTs

NINA-W101/NINA-W102 modules have three UART interfaces – UART0 to UART2, which provide asynchronous communication supporting RS232, RS485 and IrDA standards (external drivers are required). UART0 is the main port and is named UART in this document. The maximum speed is 5 Mbps. The UARTs can be routed to any GPIO pins via the IO MUX but it is recommended to keep UART0 on the default pins (see section 3.1) as the firmware upgrade is done on the UART0 default pins.

The UART provides hardware management of the CTS and RTS signals and software flow control (XON and XOFF).

2.7.2 RMII

The RMII (Reduced Media-Independent Interface) Ethernet interface is intended for connecting to an external PHY. The flow control of the UART0 interface is multiplexed with the RMII interface and cannot be used simultaneously. An MDIO (Management Data Input/Output) interface used for controlling the external PHY is also available. The pins for the MDIO interface are configurable by software but the proposed pins as specified in chapter 3 are recommended for use.

2.7.3 SPI

Two SPI interfaces are available for the application. One SPI interface with the name SPI_V and another interface by name SPI_H (the SPI_H interface is multiplexed with the JTAG and SDIO

interfaces). It is possible to connect the SPI interfaces to other pins via the IO MUX but the maximum speed will be reduced. It is also possible to configure the SPI interface as a dual or quad SPI (2 or 4 bit –bidirectional data signals), see section 2.7.4.

2.7.4 Dual/Quad SPI

The dual/quad SPI (2 or 4 bi-bidirectional data signals) can be used for connecting an additional external flash or SRAM. The SPI to dual/quad SPI signal mapping are shown in Table 4.

SPI signal	Dual SPI signal	Quad SPI signal
MOSI	IO0	IO0
MISO	IO1	IO1
WP	-	IO2
HD	-	IO3
CS	CS	CS
CLK	CLK	CLK

Table 4: SPI to dual/quad SPI signal mapping

2.7.5 I²C

Three I²C interfaces can be configured on any GPIO pins.

The NINA-W101/NINA-W102 modules can operate as both master and slave on the I²C bus using both standard (100 kbps) and fast (400 kbps) transmission speeds. The interface uses the **SCL** signal to clock instructions and data on the **SDL** signal.

2.7.6 SDIO

SDIO is multiplexed with the JTAG interface and the second SPI interface (SPI_H). It is possible to connect the SDIO interfaces to other pin via the IO MUX but the speed is limited (see section 4.2.4). Only SDIO host is supported (not SDIO slave).

2.7.7 CAN

The NINA-W101/NINA-W102 modules support CAN2.0.

2.8 Debug interfaces

2.8.1 JTAG debug interfaces

The NINA-W101 and NINA-W102 modules support the JTAG debug interface (**JTAG_TMS**, **JTAG_CLK**, **JTAG_TDI** and **JTAG_TDO**). The JTAG interface is multiplexed with the SDIO and the second SPI interface (SPI_H).

2.9 Analog interfaces

2.9.1 Analog to digital converters


The NINA-W101 and NINA-W102 modules have four pins marked as Analog to Digital Converter (ADC) input signals (**ADC_2**, **ADC_3**, **ADC_4** and **ADC_34**), see chapter 3. These pins are primarily recommended for the ADC application (to be compatible with future NINA modules). There are also 13 additional GPIO pins that can be used for ADC application (see pins marked with an ADC-CH in the “ESP-32” column of Table 5. The analog converters are 12-bit SAR ADCs. The NINA-W101 and NINAW102 modules can measure the voltages while operating in the sleep mode, to enable low power consumption; the CPU can be woken up by a threshold setting.



Analog pins cannot be re-routed to other pins via the IO MUX.

2.9.2 Digital to analog converters

Two 8-bit DAC channels **ADC_16** and **ADC_17** can be used to convert the two digital signals into two analog voltage signal outputs. The design structure is composed of integrated resistor strings and a buffer. This dual DAC has **VCC** as input voltage reference and can drive other circuits. The dual channels support independent conversions.

 Analog pins cannot be rerouted to other pins via the IO MUX.

3 Pin definition

3.1 Pin assignment

The NINA-W10 module has 36 pins in total, out of which 20 can be used as input and output and 4 signals are only inputs signals.

Figure 2 shows the multiplexed pinout for NINA-W101 and NINA-W102 Open CPU modules. Some additional interfaces that are available are not shown in Figure 2 (see Table 5 for additional interfaces). The part below the dotted line in Figure 2 is the antenna area of NINA-W102 and the outline of the NINA-W101 module ends at the dotted line. It is also possible to multiplex all interfaces via an IO MUX to any pin but the maximum speed is limited (see section 4.2.4).

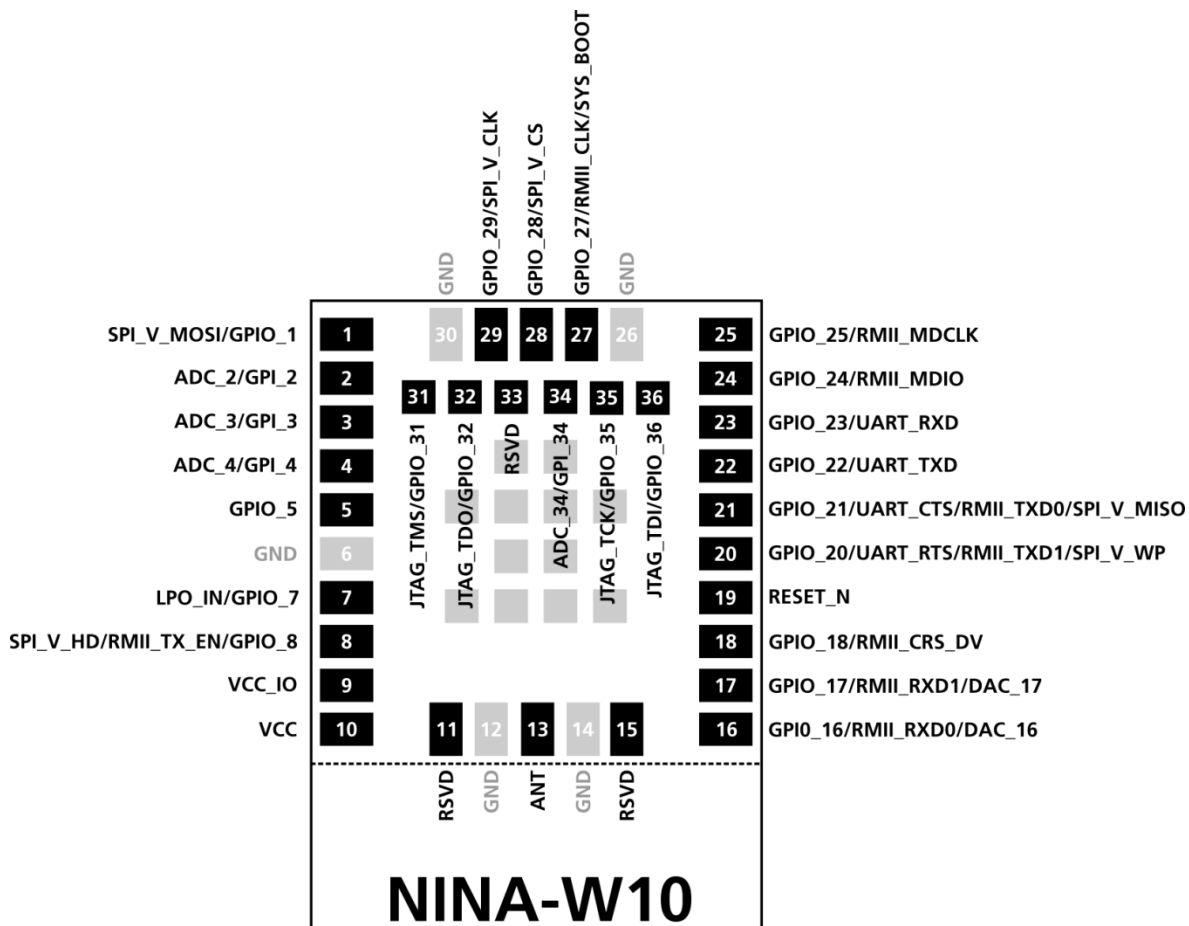


Figure 2: NINA-W10 pin assignment (top view)

- The grey pins in the center of the modules are GND pins. The lower part below the dotted line is the antenna part of NINA-W102 and the outline of the NINA-W101 module ends at this line.
- Pins 2, 3, 4, and 34 can only be used as input signals (GPI) regardless of the selected function/interface.
- Some of the signals are boot strap signals (see Table 5). It is important that these signals are in the correct state during startup (see section 2.4).

Pin	Name	Additional function	I/O	Description	ESP-32 GPIO / ADC-CH	Remarks
1	GPIO_1/ SPI_V_MOSI		I/O	General Purpose I/O / SPI (port V) Master Output Slave Input	23 /	
2	GPI_2/ ADC_2		I	General Purpose Input pin/ Analog input pin.	34 / 1-CH6	See section 2.9.1 for more info about Analog input pin. This pin is input only.
3	GPI_3/ ADC_3		I	General Purpose Input pin/ Analog input pin.	39 / 1-CH3	See section 2.9.1 for more info about Analog input pin. This pin is input only.
4	GPI_4/ ADC_4		I	General Purpose Input pin/ Analog input pin.	36 / 1-CH0	See section 2.9.1 for more info about Analog input pin. This pin is input only.
5	GPIO_5	TOUCH_9	I/O	General Purpose I/O / Touch button input	32 / 1-CH4	
6	GND			Ground		
7	GPIO_7/ LPO_IN	TOUCH_8	I/O	General Purpose I/O / Low Power Oscillator Input / Touch button input /	33 / 1-CH5	In LPO_IN mode, the required signal must be 0/0.7 V; for example, provided via an external voltage divider.
8	GPIO_8/ RMII_TXEN/ SPI_V_HD/		I/O	General Purpose I/O / RMII Transmit Enable output/ SPI (port V) Hold/	21	
9	VCC_IO		I	Module I/O level voltage input		V IO voltage supply. This pin is internally connected to VCC On NINA-B1.
10	VCC		I	Module supply voltage input		3.0-3.6 V module voltage supply.
11	RSVD			Reserved for future use.		Do not connect.
12	GND			Ground		
13	ANT		I/O	Antenna Tx/Rx interface		50 Ω nominal characteristic impedance, only used with NINA- W101 module.
14	GND			Ground		
15	RSVD		I/O	Reserved for future use.		Do not connect.
16	GPIO_16/ RMII_RXD0/ DAC_16		I/O	General Purpose I/O / RMII Receive Data input 0/ Digital to Analog Converter	25 / 2-CH8	
17	GPIO_17/ RMII_RXD1/ DAC_17		I/O	General Purpose I/O / RMII Receive Data input 1/ Digital to Analog Converter	26 / 2-CH9	
18	GPIO_18/ RMII_CRSDV	TOUCH_7	I/O	General Purpose I/O / Carrier Sense/Receive Data Valid input/ Touch button input /	27 / 2-CH7	
19	RESET_N		I	External system reset input.		Active low.
20	GPIO_20/ UART_RTS/ RMII_TXD1/ SPI_V_WP		I/O	General Purpose I/O / UART0 request to send control signal / RMII Transmit Data output 1 SPI (port V) Write Protect/	22	
21	GPIO_21/ UART_CTS/ RMII_TXD0/ SPI_V_MISO/		I/O	General Purpose I/O / UART0 clear to send control signal / RMII Transmit Data output 0/	19	

Pin	Name	Additional function	I/O	Description	ESP-32 GPIO / ADC-CH	Remarks
				SPI (port V) Master Input Slave Output		
22	GPIO_22/ UART_TXD		I/O	General Purpose I/O / UART data output	1	
23	GPIO_23/ UART_RXD		I/O	General Purpose I/O / UART data input	3	
24	GPIO_24/ RMII_MDIO	SPI_H_HD/ SDIO_D1/ TOUCH_0	I/O	General Purpose I/O / RMII Management data/ SPI (port H) Hold/ SDIO host Data bit 1/ Touch button input	4 / 2-CH0	
25	GPIO_25/ RMII_MDCLK /	SPI_H_WP/ SDIO_D0/ TOUCH_2	I/O	General Purpose I/O / RMII Management data clock/ SPI (port H) Write Protect/ SDIO host Data bit 0/ Touch button input	2 / 2-CH2	This pin is also a boot strap pin (see section 2.4).
26	GND			Ground		
27	GPIO_27/ RMII_CLK/ SYS_BOOT	TOUCH_1	I/O	General Purpose I/O / RMII clock line (input or output)/ Firmware download/ Touch button input	0 / 2-CH1	Pull low during startup for download firmware (see section 2.4).
28	GPIO_28/ SPI_V_CS		I/O	General Purpose I/O / SPI (port V) chip select	5	
29	GPIO_29/ SPI_V_CLK		I/O	General Purpose I/O / SPI (port V) clock	18	
30	GND			Ground		
31	GPIO_31/ JTAG_TMS	SPI_H_CLK/ SDIO_CLK/ TOUCH_6	I/O	General Purpose I/O / JTAG Test Mode Select/ SPI (port H) clock/ SDIO host clock/ Touch button input	14 / 2-CH6	
32	GPIO_32/ JTAG_TDO	SPI_H_CS/ SDIO_CMD/ TOUCH_3	I/O	General Purpose I/O / JTAG Test Data Out/ SPI (port H) Chip Select/ SDIO host Command/ Touch button input	15 / 2-CH3	This pin is also a boot strap pin (see section 2.4).
33	RSVD			Reserved for future use.		Do not connect.
34	GPI_34/ ADC_34		I	General Purpose Input pin/ Analog input pin.	35 / 1-CH7	This pin is input only.
35	GPIO_35/ JTAG_CLK	SPI_H_MOSI/ SDIO_D3/ TOUCH4	I/O	General Purpose I/O / JTAG Test Data In/ SPI (port H) Master Output Slave Input / SDIO host Data bit 3/ Touch button input	13 / 2-CH4	
36	GPIO_36/ JTAG_TDI/	SPI_H_MISO/ SDIO_D2/ TOUCH_5	I/O	General Purpose I/O / JTAG Test Data In (debug interface) / SPI (port H) Master Input Slave Output/ SDIO host Data bit 2/ Touch button input	12 / 2-CH5	This pin is also a boot strap pin (see section 2.4).

Table 5: NINA-W101/NINA-W102 pinout

4 Electrical specifications

Stressing the device above one or more of the ratings listed in the Absolute maximum rating section may cause permanent damage. These are stress ratings only. Operating the module at these or at any conditions other than those specified in the Operating conditions section of this document should be avoided. Exposure to absolute maximum rating conditions for extended periods may affect device reliability.

Operating condition ranges define those limits within which the functionality of the device is guaranteed. Where application information is given, it is advisory only and does not form part of the specification.

4.1 Absolute maximum ratings

Symbol	Description	Condition	Min	Max	Unit
VCC/VCC_IO	Module supply voltage	Input DC voltage at VCC and VCC_IO pins	-0.3	3.6	V
$I_{VCC\ MAX} + I_{VCC_IO\ MAX}$	Absolute maximum power consumption			500	mA
DPV	Digital pin voltage	Input DC voltage at any digital I/O pin	-0.3	3.6	V
P_ANT	Maximum power at receiver	Input RF power at antenna pin		0	dBm
Tstr	Storage temperature		-40	+85	°C

Table 6: Absolute maximum ratings

The product is not protected against overvoltage or reversed voltages. If necessary, voltage spikes exceeding the power supply voltage specification, given in table above, must be limited to values within the specified boundaries by using appropriate protection devices.

4.1.1 Maximum ESD ratings

Parameter	Min.	Typical	Max.	Unit	Remarks
ESD immunity			8	kV	Indirect discharge according to IEC 61000-4-2
ESD sensitivity			2.5	kV	Human body model according to JEDEC JS001
			250	V	Charged device model according to JESD22-C101

Table 7: Maximum ESD ratings

NINA-W10 series modules are Electrostatic Sensitive Devices and require special precautions while handling. See section 8.4 for ESD handling instructions.

4.2 Operating conditions

Operation beyond the specified operating conditions is not recommended and extended exposure beyond them may affect device reliability.

Unless otherwise specified, all operating condition specifications are at an ambient temperature of 25 °C and at a supply voltage of 3.3 V.

4.2.1 Operating temperature range

Parameter	Min	Max	Unit
Operating temperature	-40*	+85	°C

* See voltage supply condition for the lowest temperature range in section 4.2.2.

Table 8: Temperature range

4.2.2 Supply/Power pins

Symbol	Parameter	Condition	Min	Typ	Max	Unit
VCC	Input supply voltage	Ambient temperature -20 °C to +85 °C	3.00	3.30	3.60	V
		Ambient temperature -40 °C to +85 °C	3.00	3.30	3.45	V
VCC_IO	I/O reference voltage	Ambient temperature -20 °C to +85 °C	3.00	3.30	3.60	V
		Ambient temperature -40 °C to +85 °C	3.00	3.30	3.45	V

Table 9: Input characteristics of voltage supply pins

4.2.3 RESET_N pin

Pin name	Parameter	Min	Typ	Max	Unit
RESET_N	Low-level input	0		0.3*VCC	V
	Internal pull-up resistance		100		kΩ
	Internal capacitance		10		nF
t_Startup	Startup time after release of reset		2.6		s

Table 10: RESET_N pin characteristics

4.2.4 LPO clock

The NINA-W10 series module does not have an internal low power oscillator (LPO) required for low power modes. An LPO signal can be supplied to the **LPO_IN** pin from an external oscillator if low power modes are required.

The **LPO_IN** clock signal shall be limited to 0/0.7 V; for example, via an external voltage divider.

Symbol	Parameter	Min	Typ	Max	Unit
LPO _{32.768kHz}	Input clock frequency		32.768		kHz
	Input slow clock accuracy (Initial + temp + aging)			±150	ppm
Tr/Tf	Input transition time Tr/Tf -10% to 90%			100	ns
	Frequency input duty cycle	20	50	80	%
V _{IH}	Input voltage limits (Square wave, DC-coupled)	0.50	0.7	0.8	V
V _{IL}				0.2	V
	Input capacitance			10	pF

Table 11: External LPO clock characteristics

4.2.5 Digital pins

Pin name	Parameter	Min	Typ	Max	Unit	Remarks	
Any digital pin	Input characteristic: Low-level input	0		0.3*VCC_IO	V		
	Input characteristic: high-level input	0.7*VCC_IO		VCC_IO	V		
	Output characteristic: Low-level output		0		0.4	V	Normal drive strength
			0		0.4	V	High drive strength
	Output characteristic: High-level output		VCC_IO-0.4		VCC_IO	V	Normal drive strength
			VCC_IO-0.4		VCC_IO	V	High drive strength
	Pull-up/pull-down resistance		30		kΩ.		
Signals rerouted via the IO MUX	Output signal speed			20	MHz		
	Input signal speed			10	MHz	The GPIO-Matrix delays the input-signals by 2 cycles of the AHB-clock typical 80 MHz -> 25 ns delay	

Table 12: Digital pin characteristics

4.2.6 Current consumption

Typical current consumption of a NINA-W10 module is provided in Table 13. The current consumption is highly dependent on the application implementation. The consumption information listed below is taken from the Espressif ESP32 Datasheet [3].

Power mode	Activity	Typ	Max	Unit	Remarks
Wi-Fi	Wi-Fi Tx packet 16 dBm	190	320	mA	50% duty cycle
	Wi-Fi Rx and listening	100	140	mA	
Bluetooth	Bluetooth Tx Pout 0 dBm	130	230	mA	Throughput 2.1 Mbit/s
	Bluetooth Rx and listening	100		mA	Throughput 2.1 Mbit/s
Bluetooth low energy	Bluetooth Tx Pout 0 dBm	130	225	mA	Throughput 240 kbit/s
	Bluetooth Rx and listening	100		mA	Throughput 240 kbit/s
CPU idle mode	CPU speed 120 MHz	95		mA	
Modem-sleep mode	CPU speed 80 MHz. The CPU is operational. The radio is turned off.	30		mA	Immediate wake-up
Light-sleep mode	PLL and radio disabled. The CPUs are stalled. The ULP co-processor and touch controller can be periodically triggered by monitor sensors.	800		μA	Wake-up latency < 1 ms.
Deep-sleep mode	PLL and radio disabled. Digital core powered down. The CPU context is lost.	6.5		μA	Wake-up latency < 1 ms. For ultra-low-power infrequently-connected Wi-Fi/Bluetooth apps.
Hibernate mode	PLL and radio disabled. Digital core powered down. The CPU context is lost. The RTC domain is powered down.	4.5		μA	Wake-up source: RTC timer only. Wake-up latency < 1 ms. For ultra-low-power infrequently-connected Wi-Fi/Bluetooth apps.

Table 13: Current consumption during typical use cases

4.2.7 Wi-Fi radio characteristics

$V_{CC} = 3.3\text{ V}$, $T_{amb} = 25\text{ °C}$

Parameter	Operation Mode		Specification	Unit	
RF Frequency Range	802.11b/g/n		2.400 – 2.500	GHz	
Modulation	802.11b		CCK and DSSS		
	802.11g/n		OFDM		
Supported Data Rates	802.11b		1, 2, 5.5, 11	Mbps	
	802.11g		6, 9, 12, 18, 24, 36, 48, 54	Mbps	
	802.11n		MCS0 – MCS7		
Supported Bandwidth	802.11n		20	MHz	
Supported Guard Interval	802.11n		400, 800	ns	
Conducted Transmit Power (typical)	802.11b	Channel 6	1 Mbps	$13^{**} \pm 1$	dBm
			11 Mbps	$13^{**} \pm 1$	dBm
	802.11g	Channel 6	6 Mbps	$15^{**} \pm 1$	dBm
			54 Mbps	$12^{**} \pm 1$	dBm
	802.11n	Channel 6	MCS0	$15^{**} \pm 1$	dBm
			MCS7	$11^{**} \pm 1$	dBm
Receiver Sensitivity (typical)	802.11b		1 Mbps	-96 ± 2	dBm
			11 Mbps	-88 ± 2	dBm
	802.11g		6 Mbps	-92 ± 2	dBm
			54 Mbps	-74 ± 2	dBm
	802.11n	20 MHz	MCS0	-91 ± 2	dBm
			MCS7	-72 ± 2	dBm

* Maximum support for 802.11d depends on the region.

** There is lower output power on band edge channels and also on the highest data rates.

Table 14: Wi-Fi radio characteristics

4.2.8 Bluetooth radio characteristics

$V_{CC} = 3.3\text{ V}$, $T_{amb} = 25\text{ °C}$

Parameter	Operation Mode	Specification	Unit
RF Frequency Range		2.400 – 2.4835	GHz
Supported Modes		Bluetooth v4.2 + EDR	
Number of channels		79	
Modulation	1 Mbps	GFSK (BDR)	
	2 Mbps	$\pi/4$ -DQPSK (EDR)	
	3 Mbps	8-DPSK (EDR)	
Conducted Transmit Power (typical)	1 Mbps	5 ± 1	dBm
	2/3 Mbps	5 ± 1	dBm
Receiver Sensitivity (typical)	1 Mbps	-88 ± 2	dBm
	2 Mbps	-86 ± 2	dBm
	3 Mbps	-80 ± 2	dBm

Table 15: Bluetooth radio characteristics

4.2.9 Bluetooth low energy characteristics

$V_{CC} = 3.3\text{ V}$, $T_{amb} = 25\text{ °C}$

Parameter	Specification	Unit
RF Frequency Range	2.400 – 2.4835	GHz
Supported Modes	Bluetooth v4.2	
Number of channels	40	
Modulation	GFSK	
Transmit Power (typical)	5 ± 1	dBm
Receiver Sensitivity (typical)	-88 ± 2	dBm

Table 16: Bluetooth low energy characteristics

5 Mechanical specifications

5.1 NINA-W101 Mechanical specification

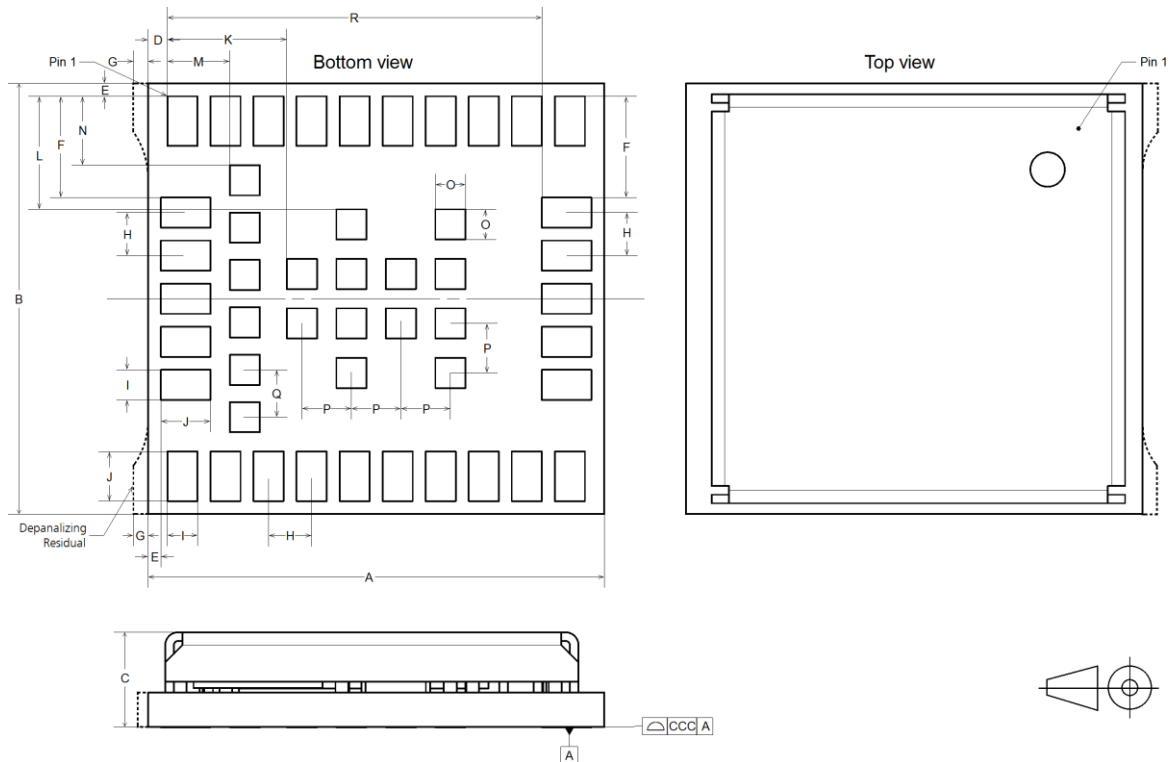


Figure 3: NINA-W101 mechanical outline

Parameter	Description	Typical		Tolerance
A	Module PCB Length [mm]	10.6	(417.3 mil)	+0.20/-0.10 (+7.9/-3.9 mil)
B	Module PCB Width [mm]	10.0	(393.7 mil)	+0.20/-0.10 (+7.9/-3.9 mil)
C	Module Thickness [mm]	2.2	(86.6 mil)	+0.40/-0.20 (+15.8/-7.9 mil)
ccc	Seating Plane Coplanarity [mm]	0.10	(3.9 mil)	+0.02/-0.10 (+0.8/-3.9 mil)
D	Horizontal Edge to Lateral Pin No 1 Edge [mm]	0.45	(17.7 mil)	+0.10/-0.10 (+3.9/-3.9 mil)
E	Vertical and Horizontal Edge to Lateral Pin No 1 Edge	0.30	(11.8 mil)	+0.10/-0.10 (+3.9/-3.9 mil)
F	Vertical Pin No1 Edge to Lateral Pin Edge [mm]	2.35	(92.5 mil)	+0.05/-0.05 (+2.0/-2.0 mil)
G	Depanalizing Residual [mm]	0.10	(3.9 mil)	+0.25/-0.10 (+9.8/-3.9 mil)
H	Lateral and Antenna Row Pin to Pin Pitch [mm]	1.0	(39.4 mil)	+0.05/-0.05 (+2.0/-2.0 mil)
I	Lateral and Antenna Row Pin Width [mm]	0.70	(27.6 mil)	+0.05/-0.05 (+2.0/-2.0 mil)
J	Lateral and Antenna Row Pin Height [mm]	1.15	(45.3 mil)	+0.05/-0.05 (+2.0/-2.0 mil)
K	Horizontal Pin No1 Edge to Central Pin Edge [mm]	2.78	(109.4 mil)	+0.05/-0.05 (+2.0/-2.0 mil)
L	Vertical Pin No1 Edge to Central Pin Edge [mm]	2.63	(103.5 mil)	+0.05/-0.05 (+2.0/-2.0 mil)
M	Horizontal Pin No1 Edge to Inner Row Pin Edge [mm]	1.45	(57.1 mil)	+0.05/-0.05 (+2.0/-2.0 mil)
N	Vertical Pin No1 Edge to Inner Row Pin Edge [mm]	1.6	(63.0 mil)	+0.05/-0.05 (+2.0/-2.0 mil)
O	Central Pin and Inner Row Width and Height [mm]	0.70	(27.6 mil)	+0.05/-0.05 (+2.0/-2.0 mil)
P	Central Pin to Central Pin Pitch [mm]	1.15	(45.3 mil)	+0.05/-0.05 (+2.0/-2.0 mil)
Q	Inner Row Pin to Pin Pitch [mm]	1.1	(43.3 mil)	+0.05/-0.05 (+2.0/-2.0 mil)
R	Horizontal Pin No1 Edge to Antenna Row Pin Edge [mm]	8.7	(342.5 mil)	+0.05/-0.05 (+2.0/-2.0 mil)
	Module Weight [g]	<1.0		

Table 17: NINA-W101 mechanical outline data

5.2 NINA-W102 Mechanical specification

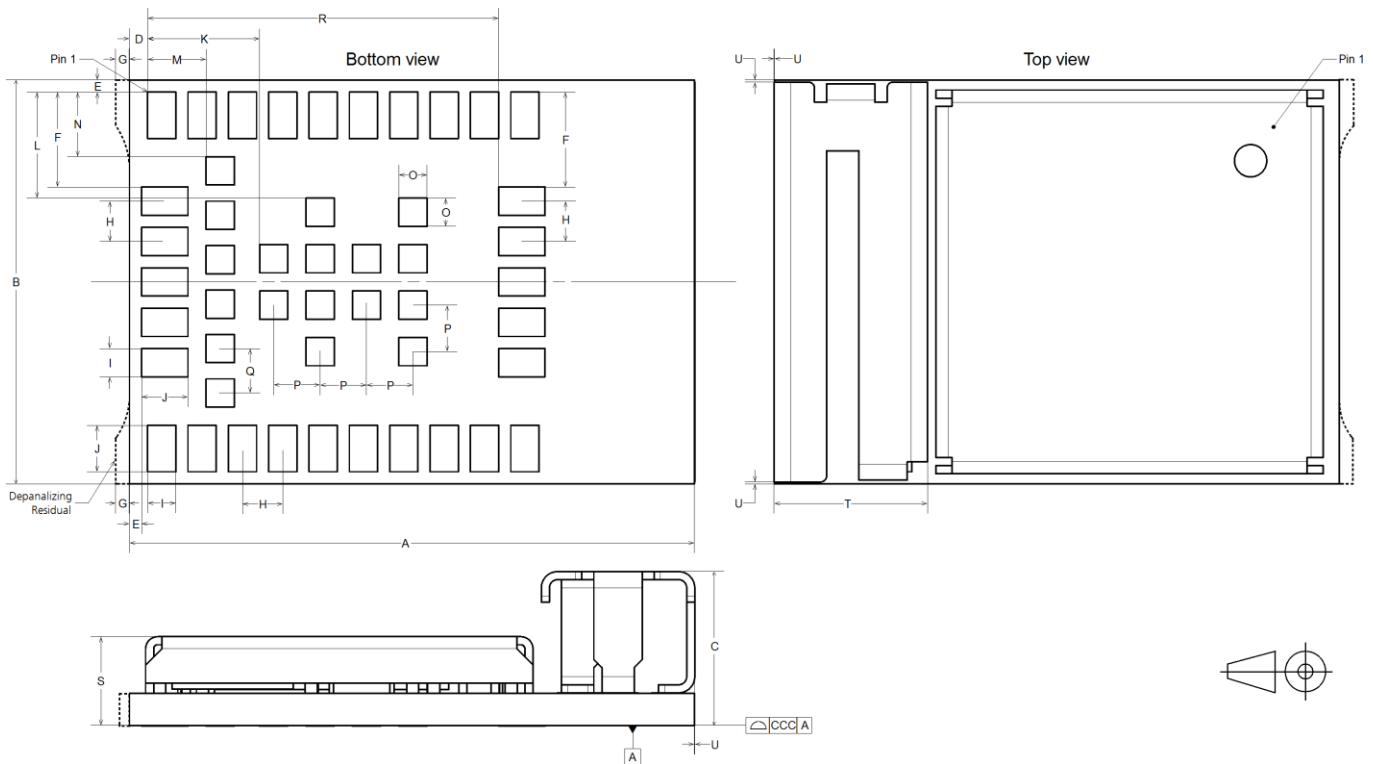


Figure 4: NINA-W102 mechanical outline

Parameter	Description	Typical		Tolerance	
A	Module PCB Length [mm]	14.0	(551.2 mil)	+0.20/-0.10	(+7.9/-3.9 mil)
B	Module PCB Width [mm]	10.0	(393.7 mil)	+0.20/-0.10	(+7.9/-3.9 mil)
C	Module Thickness [mm]	3.8	(149.6 mil)	+0.40/-0.20	(+15.8/-7.9)
ccc	Seating Plane Coplanarity [mm]	0.10	(3.9 mil)	+0.02/-0.10	(+0.8/-3.9 mil)
D	Horizontal Edge to Lateral Pin No 1 Edge [mm]	0.45	(17.7 mil)	+0.10/-0.10	(+3.9/-3.9 mil)
E	Vertical and Horizontal Edge to Lateral Pin No 1 Edge	0.30	(11.8 mil)	+0.10/-0.10	(+3.9/-3.9 mil)
F	Vertical Pin No1 Edge to Lateral Pin Edge [mm]	2.35	(92.5 mil)	+0.05/-0.05	(+2.0/-2.0 mil)
G	Depanaling Residual [mm]	0.10	(3.9 mil)	+0.25/-0.10	(+9.8/-3.9 mil)
H	Lateral and Antenna Row Pin to Pin Pitch [mm]	1.0	(39.4 mil)	+0.05/-0.05	(+2.0/-2.0 mil)
I	Lateral and Antenna Row Pin Width [mm]	0.70	(27.6 mil)	+0.05/-0.05	(+2.0/-2.0 mil)
J	Lateral and Antenna Row Pin Height [mm]	1.15	(45.3 mil)	+0.05/-0.05	(+2.0/-2.0 mil)
K	Horizontal Pin No1 Edge to Central Pin Edge [mm]	2.78	(109.4 mil)	+0.05/-0.05	(+2.0/-2.0 mil)
L	Vertical Pin No1 Edge to Central Pin Edge [mm]	2.63	(103.5 mil)	+0.05/-0.05	(+2.0/-2.0 mil)
M	Horizontal Pin No1 Edge to Inner Row Pin Edge [mm]	1.45	(57.1 mil)	+0.05/-0.05	(+2.0/-2.0 mil)
N	Vertical Pin No1 Edge to Inner Row Pin Edge [mm]	1.6	(63.0 mil)	+0.05/-0.05	(+2.0/-2.0 mil)
O	Central Pin and Inner Row Width and Height [mm]	0.70	(27.6 mil)	+0.05/-0.05	(+2.0/-2.0 mil)
P	Central Pin to Central Pin Pitch [mm]	1.15	(45.3 mil)	+0.05/-0.05	(+2.0/-2.0 mil)
Q	Inner Row Pin to Pin Pitch [mm]	1.1	(43.3 mil)	+0.05/-0.05	(+2.0/-2.0 mil)
R	Horizontal Pin No1 Edge to Antenna Row Pin Edge	8.7	(342.5 mil)	+0.05/-0.05	(+2.0/-2.0 mil)
S	PCB and Shield Cover Thickness [mm]	2.2	(86.6 mil)	+0.40/-0.20	(+15.8/-7.9)
T	Module Antenna Width [mm]	3.8	(149.6 mil)	+0.20/-0.20	(+7.9/-7.9 mil)
U	Antenna overhang outside module outline on any side	0.0	(0.0 mil)	+0.60	(+23.6 mil)
	Module Weight [g]	<1.0			

Table 18: NINA-W102 mechanical outline data

6 Qualification and approvals

6.1 Country approvals

The NINA-W10 module series is certified for use in the following countries/regions:

- Europe (RED)
- USA (FCC)
- Canada (IC)
- Japan (MIC)
- Taiwan (NCC)
- South Korea (KCC)
- Brazil (ANATEL)
- Australia and New Zealand (ACMA)
- South Africa (ICASA)

See the following sections for additional information.

6.2 European Union regulatory compliance

Information about regulatory compliance of the European Union for NINA-W10 series modules is available in the NINA-W10 Declaration of Conformity [4].

6.2.1 Radio Equipment Directive (RED) 2014/53/EU

The NINA-W10 series modules comply with the essential requirements and other relevant provisions of the Radio Equipment Directive (RED) 2014/53/EU.


6.2.2 Compliance with the RoHS directive

The NINA-W10 series modules complies with the Directive 2011/65/EU (EU RoHS 2) and its amendment Directive (EU) 2015/863 (EU RoHS 3).

6.3 FCC/IC Compliance


This device complies with Part 15 of the FCC Rules and with Industry Canada license-exempt RSS standard(s).

6.3.1 Open CPU responsibility and obligations

-  Note that the FCC/IC modular transmitter approvals for NINA-W10 only allow u-blox AG to integrate the module into an end-product. The integration of the module into an end-product can only be made by the grantee himself. To allow someone else to integrate NINA-W10 into an end-product, u-blox AG will help the integrator to obtain the status as grantee. The status as grantee is obtained by performing a “change in ID”/”Multiple listing”.

The term “Change in ID” relates to § 2.933 of Title 47 of the Code of Federal Regulations (CFR) and the term Multiple listing relates to section 8.4 of Radio Standards Procedure RSP- 100.

Please contact u-blox support for more information regarding the “Change in ID”/”Multiple listing” process.

-  Any changes or modifications NOT explicitly APPROVED by the grantee may cause the module to cease to comply with the FCC rules part 15 thus void the user’s authority to operate the equipment.

6.3.1.1 FCC Compliance

The NINA-W10 modules are for OEM integrations only. The end-product will be professionally installed in such manner that only the authorized antennas can be used.

For NINA-W101, an external antenna connector (U.FL. connector) reference design is available and must be followed to comply with the NINA-W10 FCC/IC modular approval (see the NINA-W1 Series System Integration Manual [1]).

6.3.1.2 FCC statement

This device complies with Part 15 of the FCC Rules. Operation is subject to the following two conditions:

1. This device may not cause harmful interference, and
2. This device must accept any interference received, including interference that may cause undesired operation.

This equipment has been tested and found to comply with the limits for a Class B digital device, pursuant to Part 15 of the FCC Rules. These limits are designed to provide reasonable protection against harmful interference in a residential installation. This equipment generates, uses and can radiate radio frequency energy and, if not installed and used in accordance with the instructions, may cause harmful interference to radio communications. However, there is no guarantee that the interference will not occur in a particular installation. If this equipment does cause harmful interference to radio or television reception, which can be determined by turning the equipment off and on, the user is encouraged to try to correct the interference by one or more of the following measures:

- Reorient or relocate the receiving antenna
- Increase the separation between the equipment and receiver
- Connect the equipment into an outlet on a circuit different from that to which the receiver is connected.
- Consult the dealer or an experienced radio/TV technician for help.

6.3.2 RF-exposure statement

6.3.2.1 IC Compliance

This equipment complies with the requirements of IC RSS-102 issue 5 radiation exposure limits set forth for an uncontrolled environment.

Having a separation distance of minimum 30 mm between the user and/or bystander and the antenna and /or radiating element ensures that the output power (e.i.r.p.) of NINA-W101 and NINA-W102 is below the SAR evaluation Exemption limits defined in RSS-102 issue 5.


6.3.2.2 FCC Compliance

This device complies with the FCC radiation exposure limits set forth for an uncontrolled environment.

Having a separation distance of minimum 25 mm between the user and/or bystander and the antenna and /or radiating element ensures that max output power of NINA-W101 and NINA-W102 is below the SAR test exclusion limits presented in KDB 447498 D01v06.

6.3.3 End-product user manual instructions


6.3.3.1 IC Compliance

-  User manuals for license-exempt radio apparatus shall contain the following text, or an equivalent notice that shall be displayed in a conspicuous location, either in the user manual or on the device, or both:

This device complies with Industry Canada's license-exempt RSSs. Operation is subject to the following two conditions:

- (1) This device may not cause interference; and*
- (2) This device must accept any interference, including interference that may cause undesired operation of the device.*

Under Industry Canada regulations, this radio transmitter can only operate using an antenna of a type and maximum (or lesser) gain approved for the transmitter by Industry Canada. To reduce potential radio interference to other users, the antenna type and its gain should be chosen in such a way that the equivalent isotropically radiated power (e.i.r.p.) is not more than that is necessary for successful communication.

-  Le manuel d'utilisation des appareils radio exempts de licence doit contenir l'énoncé qui suit, ou l'équivalent, à un endroit bien en vue dans le manuel d'utilisation ou sur l'appareil, ou encore aux deux endroits.

Le présent appareil est conforme aux CNR d'Industrie Canada applicables aux appareils radio exempts de licence. L'exploitation est autorisée aux deux conditions suivantes:

- (1) l'appareil ne doit pas produire de brouillage;*
- (2) l'utilisateur de l'appareil doit accepter tout brouillage radioélectrique subi, même si le brouillage est susceptible d'en compromettre le fonctionnement.*

Conformément aux réglementations d'Industry Canada, cet émetteur radio ne peut fonctionner qu'à l'aide d'une antenne dont le type et le gain maximal (ou minimal) ont été approuvés pour cet émetteur par Industry Canada. Pour réduire le 25ecess d'interférences avec d'autres utilisateurs, il faut choisir le type d'antenne et son gain de telle sorte que la puissance isotrope rayonnée équivalente (p.i.r.e) ne soit pas supérieure à celle requise pour obtenir une communication satisfaisante.

6.3.4 End-product labeling requirements

6.3.4.1 IC Compliance

The host product shall be properly labelled to identify the modules within the host product.

The Innovation, Science and Economic Development Canada certification label of a module shall be clearly visible at all times when installed in the host product; otherwise, the host product must be labelled to display the Innovation, Science and Economic Development Canada certification number for the module, preceded by the word "Contains" or similar wording expressing the same meaning, as shown in figure Figure 5.

Le produit hôte devra être correctement étiqueté, de façon à permettre l'identification des modules qui s'y trouvent.

L'étiquette d'homologation d'un module d'Innovation, Sciences et Développement économique Canada devra être posée sur le produit hôte à un endroit bien en vue, en tout temps. En l'absence d'étiquette, le produit hôte doit porter une 25ecessair sur laquelle figure le numéro d'homologation

du module d’Innovation, Sciences et Développement économique Canada, précédé du mot « contient », ou d’une formulation similaire allant dans le même sens et qui va comme suit:

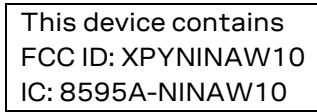


Figure 5 Example of an end product label

6.3.4.2 FCC Compliance

For an end product that uses the NINA-W101 or NINA-W102 modules, there must be a label containing, at least, the information shown in Figure 5:

The label must be affixed on an exterior surface of the end product such that it will be visible upon inspection in compliance with the modular approval guidelines developed by the FCC.



In accordance with 47 CFR § 15.19, the end-product shall bear the following statement in a conspicuous location on the device: “This device complies with Part 15 of the FCC Rules. Operation is subject to the following two conditions;

- (1) this device may not cause harmful interference, and
- (2) this device must accept any interference received, including interference that may cause undesired operation.”

When the device is so small or for such use that it is not practicable to place the statement above on it, the information shall be placed in a prominent location in the instruction manual or pamphlet supplied to the user or, alternatively, shall be placed on the container in which the device is marketed.

In case, where the final product will be installed in locations where the end-user is not able to see the FCC ID and/or this statement, the FCC ID and the statement shall also be included in the end-product manual.

Model	FCC ID	ISED Certification Number
NINA-W101	XPYNINAW10	8595A-NINAW10
NINA-W102	XPYNINAW10	8595A-NINAW10

Table 19: FCC and ISED Certification Number for the NINA-W10 series modules

6.3.5 End-product compliance

6.3.5.1 General requirements

- Any changes to hardware, hosts or co-location configuration may require new radiated emission and SAR evaluation and/or testing.
- The regulatory compliance of NINA-W101 and NINA-W102 does not exempt the end-product from being evaluated against applicable regulatory demands; for example, FCC Part 15B criteria for unintentional radiators.
- Only authorized antenna(s) may be used.
- Any notification to the end user about how to install or remove the integrated radio module is NOT allowed.

6.3.5.2 Co-location (simultaneous transmission)

If the module is to be co-located with another transmitter, additional measurements for simultaneous transmission are required.

6.4 Japan radio equipment compliance



Figure 6: Giteki mark, **R** and the NINA-W101/NINA-W102 MIC certification number

For information about compliance of the NINA-W101/NINA-W102 modules with the Giteki certification, see the NINA-W1 Series System Integration Manual [1].

6.5 NCC Taiwan compliance

6.5.1 Taiwan NCC Warning Statement

- 經型式認證合格之低功率射頻電機，非經許可，公司、商號或使用者均不得擅自變更頻率、加大功率或變更原設計之特性及功能。
- 低功率射頻電機之使用不得影響飛航安全及干擾合法通信；經發現有干擾現象時，應立即停用，並改善至無干擾時方得繼續使用。前項合法通信，指依電信法規定作業之無線電通信。低功率射頻電機須忍受合法通信或工業、科學及醫療用電波輻射性電機設備之干擾。

Statement translation:

- Without permission granted by the NCC, any company, enterprise, or user is not allowed to change frequency, enhance transmitting power or alter original characteristic as well as performance to an approved low power radio-frequency devices.
- The low power radio-frequency devices shall not influence aircraft security and interfere legal communications; If found, the user shall cease operating immediately until no interference is achieved. The said legal communications means radio communications is operated in compliance with the Telecommunications Act. The low power radio-frequency devices must be susceptible with the interference from legal communications or ISM radio wave radiated devices.

6.5.2 NINA-W101 labeling requirements for end product

When a product integrated with an NINA-W101 module is placed on the Taiwan market, the product must be affixed with a label marking as shown below. The label can use wording such as the following:

Contains Transmitter Module

內含發射器模組:  CCAJ18LP0B40T1

or any similar wording that expresses the same meaning may be used. The marking must be visible for inspection.

6.5.3 NINA-W102 labeling requirements for end product

When a product integrated with an NINA-W102 module is placed on the Taiwan market, the product must be affixed with a label marking as shown below. The label can use wording such as the following:

Contains Transmitter Module

內含發射器模組:  CCAJ18LP0B50T1

or any similar wording that expresses the same meaning may be used. The marking must be visible for inspection.

6.6 KCC South Korea compliance

The NINA-W10 series modules are certified by the Korea Communications Commission (KCC).

When a product containing a NINA-10 module is placed on the South Korean market, the product must be affixed with a label or marking containing the KCC logo and certification number shown in the figure below. NINA-W101 and NINA-W102 has the same certification number as the NINA-W15. This information must also be included in the products user manuals.



The height of the KCC logo must be at least 5 mm.

6.7 Brazil compliance

When a product containing NINA-W101 or NINA-W102 modules is placed on the Brazilian market, the product must be affixed with a label or marking containing the Anatel logo, NINA-W101/NINA-W102 Homologation number: 06870-18-05903 and a statement claiming that the device may not cause harmful interference but must accept it (Resolution No 506).



“Este equipamento opera em caráter secundário, isto é, não tem direito a proteção contra interferência prejudicial, mesmo de estações do mesmo tipo, e não pode causar interferência a sistemas operando em caráter primário.”

Statement translation:

“This equipment operates on a secondary basis and, consequently, must accept harmful interference, including from stations of the same kind, and may not cause harmful interference to systems operating on a primary basis.”

When the device is so small or for such use that it is not practicable to place the statement above on it, the information shall be placed in a prominent location in the instruction manual or pamphlet supplied to the user or, alternatively, shall be placed on the container in which the device is marketed.

In case, where the final product will be installed in locations where the end user is unable to see the Anatel logo, NINA-W101/NINA-W102 Homologation number and/or this statement, the Anatel logo, NINA-W101/NINA-W102 Homologation number, and the statement shall also be included in the end product manual.

6.8 Australia and New Zealand regulatory compliance



The NINA-W101 and NINA-W102 modules are compliant with the standards made by the Australian Communications and Media Authority (ACMA).

The modules are compliant with AS/NZS 4268:2012 standard – Radio equipment and systems – Short range devices – Limits and methods of standard measurement. The NINA-W101/NINA-W102 modules test reports can be used as part of the product certification and compliance folder. For

more information on the test reports, send an email to the respective support team mail address as mentioned in the Contact section based on your location.

To meet overall Australian and/or New Zealand end product compliance, the integrator must create a compliance folder containing all the relevant compliance test reports such as RF, EMC, electrical safety and DoC (Declaration of Conformity) and so on. It is the responsibility of the integrator to know what is required in the compliance folder for ACMA compliance.

For more information on Australia compliance, refer to the Australian Communications and Media Authority web site <http://www.acma.gov.au/>.

For more information on New Zealand compliance, refer to the New Zealand Radio Spectrum Management Group web site www.rsm.govt.nz.

6.9 South Africa regulatory compliance

The NINA-W101 and NINA-W102 modules are compliant and certified by the Independent Communications Authority of South Africa (ICASA). End products that are made available for sale or lease or is supplied in any other manner in South Africa shall have a legible label permanently affixed to its exterior surface. The label shall have the ICASA logo and the ICASA issued license number as shown in the figure below. The minimum width and height of the ICASA logo shall be 3 mm. The approval labels must be purchased by the customer’s local representative directly from the approval authority ICASA. A sample of an NINA-W101/NINA-W102 ICASA label is included below:




More information on registration as a Responsible Integrator and labeling requirements can be found at the following website:

Independent Communications Authority of South Africa (ICASA) web site - <https://www.icasa.org.za>

6.10 Safety Compliance

In order to fulfill the safety standard EN 60950-1, the NINA-W10 series modules must be supplied with a Class-2 Limited Power Source.

6.11 Bluetooth qualification information

 The NINA-W101 and NINA-W102 modules have been qualified as a controller subsystem according to the Bluetooth 4.2 specification.



Product type	QD ID	Listing Date
Controller Subsystem	107058	14-Mar-2018
Host Subsystem	110883	30-Apr-2018

Table 20: NINA-W101/NINA-W102 Bluetooth QD ID

For information on how to list and declare your product, see the NINA-W1 series System Integration Manual [1].

7 Antennas

This chapter gives an overview of the different external antennas that can be used together with the module.

-  This radio transmitter IC: 8595A-NINAW10 has been approved by Industry Canada to operate with the antenna types listed below with the maximum permissible gain and required antenna impedance for each antenna type indicated. Antenna types not included in this list, having a gain greater than the maximum gain indicated for that type, are strictly prohibited for use with this device.
-  Cet émetteur radio IC: 8595A-NINAW10 été approuvé par Industry Canada pour fonctionner avec les types d'antenne énumérés ci-dessous avec le gain maximum autorisé et l'impédance 34 nécessaire pour chaque type d'antenne indiqué. Les types d'antenne ne figurant pas dans cette liste et ayant un gain supérieur au gain maximum indiqué pour ce type-là sont strictement interdits d'utilisation avec cet appareil.

For each antenna, the “Approvals” field defines in which test reports the antenna is included. Definitions of the «Approvals» field are:

- FCC – The antenna is included in the FCC test reports and thus approved for use in countries that accept the FCC radio approvals, primarily US.
- IC – The antenna is included in the IC (Industrie Canada) test reports and thus approved for use in countries that accept the IC radio approvals, primarily Canada.
- RED – The antenna is included in the ETSI test reports and thus approved for use in countries that accept the Radio Equipment Directive, primarily the European countries.
- MIC – The antenna is included in the Japanese government affiliated MIC test reports and thus approved for use in the Japanese market.
- NCC – The antenna is included in the Taiwan NCC test reports and thus approved for use in Taiwan.
- KCC - The antenna is included in the Korea KCC test reports and thus approved for use in Korea.
- ANATEL – The antenna is included in the Brazil Anatel test reports and thus approved for use in Brazil.
- ACMA – The antenna is included in the Australia and New Zealand test reports and thus approved for use in Australia and New Zealand.
- ICASA – The antenna is included in the South Africa ICASA test reports and thus approved for use in South Africa.

In general, antennas with SMD connection, Reverse Polarity SMA connector or U.FL connector are included in FCC, IC, RED, MIC, NCC, KCC, ANATEL, ACMA and ICASA radio tests. The antennas with SMA connector are included in RED, MIC, NCC, KCC, ANATEL, ACMA and ICASA radio tests but not in the FCC or IC due to FCC/IC regulations.

The external antennas are connected to the board through U.FL connectors. Some antennas are connected directly to the U.FL connector of the board while some are connected using an SMA or reversed polarity SMA connector through a short U.FL to SMA or reversed polarity SMA adapter cable.

7.1 Antenna accessories

Name	U.FL to SMA adapter cable
Connector	U.FL and SMA jack (outer thread and pin receptacle)
Impedance	50 Ω
Minimum cable loss	0.5 dB, The cable loss must be above the minimum cable loss to meet the regulatory requirements. Minimum cable length 100 mm.
Comment	The SMA connector can be mounted in a panel. See NINA-W1 Series System Integration Manual [1] for information how to integrate the U.FL connector.
Approval	RED, MIC, NCC, KCC, ANATEL, ACMA and ICASA



Name	U.FL to Reverse Polarity SMA adapter cable
Connector	U.FL and Reverse Polarity SMA jack (outer thread and pin)
Impedance	50 Ω
Minimum cable loss	0.5 dB, The cable loss must be above the minimum cable loss to meet the regulatory requirements. Minimum cable length 100 mm.
Comment	The Reverse Polarity SMA connector can be mounted in a panel. See NINA-W1 Series System Integration Manual [1] for information how to integrate the U.FL connector. It is required to followed this reference design to comply with the NINA-W1 FCC/IC modular approvals.
Approval	FCC, IC, RED, MIC, NCC, KCC, ANATEL, ACMA and ICASA



7.2 Approved antennas

7.2.1 Single band antennas

NINA-W102	
Manufacturer	ProAnt
Gain	+3 dBi
Impedance	50 Ω
Size (HxWxL)	3.0 x 3.8 x 9.9 mm
Type	PIFA
Comment	SMD PIFA antenna on NINA-W102. Should not be mounted inside a metal enclosure, see section for more info 2.5.1.
Approval	FCC, IC, RED, MIC, NCC, KCC, ANATEL, ACMA and ICASA



GW.26.0111

Manufacturer	Taoglas
Polarization	Vertical
Gain	+2.0 dBi
Impedance	50 Ω
Size	\varnothing 7.9 x 30.0 mm
Type	Monopole
Connector	SMA (M) .
Comment	To be mounted on the U.FL to SMA adapter cable.
Approval	RED, MIC, NCC, KCC, ANATEL, ACMA and ICASA


ANT-2.4-CW-RH-RPS

Manufacturer	Linx
Polarization	Vertical
Gain	-1.0 dBi
Impedance	50 Ω
Size	\varnothing 7.4 x 27.0 mm
Type	Monopole
Connector	Reverse Polarity SMA plug (inner thread and pin receptacle).
Comment	To be mounted on the U.FL to Reverse Polarity SMA adapter cable. An SMA version antenna is also available but not recommended for use (ANT-2.4-CW-RH-SMA).
Approval	FCC, IC, RED, MIC, NCC, KCC, ANATEL, ACMA and ICASA


Ex-IT 2400 RP-SMA 28-001

Manufacturer	ProAnt
Polarization	Vertical
Gain	+3.0 dBi
Impedance	50 Ω
Size	\varnothing 12.0 x 28.0 mm
Type	Monopole
Connector	Reverse Polarity SMA plug (inner thread and pin receptacle).
Comment	This antenna requires to be mounted on a metal ground plane for best performance. To be mounted on the U.FL to Reverse Polarity SMA adapter cable. An SMA version antenna is also available but not recommended for use (Ex-IT 2400 SMA 28-001).
Approval	FCC, IC, RED, MIC, NCC, KCC, ANATEL, ACMA and ICASA



Ex-IT 2400 MHF 28

Manufacturer	ProAnt
Polarization	Vertical
Gain	+2.0 dBi
Impedance	50 Ω
Size	\varnothing 12.0 x 28.0 mm
Type	Monopole
Cable length	100 mm
Connector	U.FL. connector
Comment	<p>This antenna requires to be mounted on a metal ground plane for best performance.</p> <p>To be mounted on a U.FL connector.</p> <p>See NINA-W10 series System Integration Manual [1] for information how to integrate the U.FL connector. It is required to followed this reference design to comply with the NINA -W1 FCC/IC modular approvals.</p>
Approval	FCC, IC, RED, MIC, NCC, KCC, ANATEL, ACMA and ICASA


Ex-IT 2400 RP-SMA 70-002

Manufacturer	ProAnt
Polarization	Vertical
Gain	+3.0 dBi
Impedance	50 Ω
Size	\varnothing 10 x 83 mm
Type	Monopole
Connector	Reverse Polarity SMA plug (inner thread and pin receptacle)
Comment	<p>To be mounted on the U.FL to Reverse Polarity SMA adapter cable. An SMA version antenna is also available but not recommended for use (Ex-IT 2400 SMA 70-002).</p>
Approval	FCC, IC, RED, MIC, NCC, KCC, ANATEL, ACMA and ICASA


Ex-IT 2400 MHF 70-001

Manufacturer	ProAnt
Polarization	Vertical
Gain	+3.0 dBi
Impedance	50 Ω
Size	\varnothing 9.4 x 70.5 mm
Type	Monopole
Cable length	100 mm
Connector	U.FL. connector
Comment	<p>To be mounted on a U.FL connector.</p> <p>See NINA-W1 Series System Integration Manual [1] for information how to integrate the U.FL connector. It is required to followed this reference design to comply with the NINA-W1 FCC/IC modular approvals.</p>
Approval	FCC, IC, RED, MIC, NCC, KCC, ANATEL, ACMA and ICASA



InSide-2400

Manufacturer	ProAnt
Gain	+3.0 dBi
Impedance	50 Ω
Size	27 x 12 mm (triangular)
Type	Patch
Cable length	100 mm
Connector	U.FL. connector
Comment	Should be attached to a plastic enclosure or part for best performance. To be mounted on a U.FL connector. See NINA-W1 Series System Integration Manual [1] for information how to integrate the U.FL connector. It is required to followed this reference design to comply with the NINA-W1 FCC/IC modular approvals.
Approval	FCC, IC, RED, MIC, NCC, KCC, ANATEL, ACMA and ICASA



FlatWhip-2400

Manufacturer	ProAnt
Gain	+3.0 dBi
Impedance	50 Ω
Size	\varnothing 50.0 x 30.0 mm
Type	Monopole
Connector	SMA plug (inner thread and pin)
Comment	To be mounted on the U.FL to SMA adapter cable.
Approval	RED, MIC, NCC, KCC, ANATEL, ACMA and ICASA



Outside-2400

Manufacturer	ProAnt
Gain	+3.0 dBi
Impedance	50 Ω
Size	36.0 x 18.0 x 16.0 mm
Type	Patch
Cable length	70 mm
Connector	U.FL. connector
Comment	To be mounted on a U.FL connector. See NINA-W1 Series System Integration Manual [1] for information how to integrate the U.FL connector. It is required to followed this reference design to comply with the NINA-W1 FCC/IC modular approvals.
Approval	FCC, IC, RED, MIC, NCC, KCC, ANATEL, ACMA and ICASA



7.2.2 Dual-band antennas

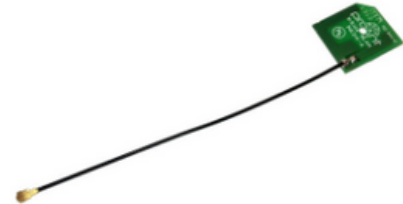
InSide-WLAN

Manufacturer	ProAnt
Gain	+3.0 dBi
Impedance	50 Ω
Size	27 x 12 mm (triangular)
Type	Patch
Cable length	100 mm
Connector	U.FL. connector
Comment	Should be attached to a plastic enclosure or part for best performance. Dual-band (2.4 GHz / 5 GHz) antenna to be mounted on a U.FL connector. See NINA-W1 Series System Integration Manual [1] for information how to integrate the U.FL connector. It is required to followed this reference design to comply with the NINA-W1 FCC/IC modular approvals.
Approval	FCC, IC, RED, MIC, NCC, KCC, ANATEL, ACMA and ICASA



InSide-WLAN Square

Manufacturer	ProAnt
Gain	+3.0 dBi
Impedance	50 Ω
Size	24x22x1 mm with mounting hole
Type	Patch
Cable length	100 mm
Connector	U.FL. connector
Comment	Should be attached to a plastic enclosure or part for best performance. Dual-band (2.4 GHz / 5 GHz) antenna to be mounted on a U.FL connector. See NINA-W1 Series System Integration Manual [1] for information on how to integrate the U.FL connector. It is required to followed this reference design to comply with the NINA-W1 FCC/IC modular approvals.
Approval	FCC, IC, RED, MIC, NCC, KCC, ANATEL, ACMA and ICASA



Ex-IT WLAN RPSMA

Manufacturer	ProAnt
Type	½ wave dipole dual-band antenna
Polarization	Vertical
Gain	+3 dBi
Impedance	50 Ω
Size	107 mm (Straight)
Type	Monopole
Connector	Reverse Polarity SMA plug (inner thread and pin receptacle)
Comment	To be mounted on the U.FL to Reverse Polarity SMA adapter cable.
Approval	FCC, IC, RED, MIC, NCC, KCC, ANATEL, ACMA and ICASA



8 Product handling

8.1 Packaging

⚠ The NINA-W10 series modules are in development status as mentioned in the table on page 2. Hence, the information in this section will be valid and available only when the module is fully tested and approved in the Initial Production stage.

8.1.1 Reels

The NINA-W10 series modules are delivered as hermetically sealed, reeled tapes to enable efficient production, production lot set-up and tear-down. For more information about packaging, see the u-blox Package Information Guide [2].

NINA-W1 modules are deliverable in quantities of 500 pieces on a reel. The reel types for the NINA-W10 modules are provided in Table 21 and detailed information about the reel types are described in u-blox Package Information Guide [2].

Model	Reel Type
NINA-W101	B
NINA-W102	A

Table 21: Reel types for different models of the NINA-W10 series

8.1.2 Tapes

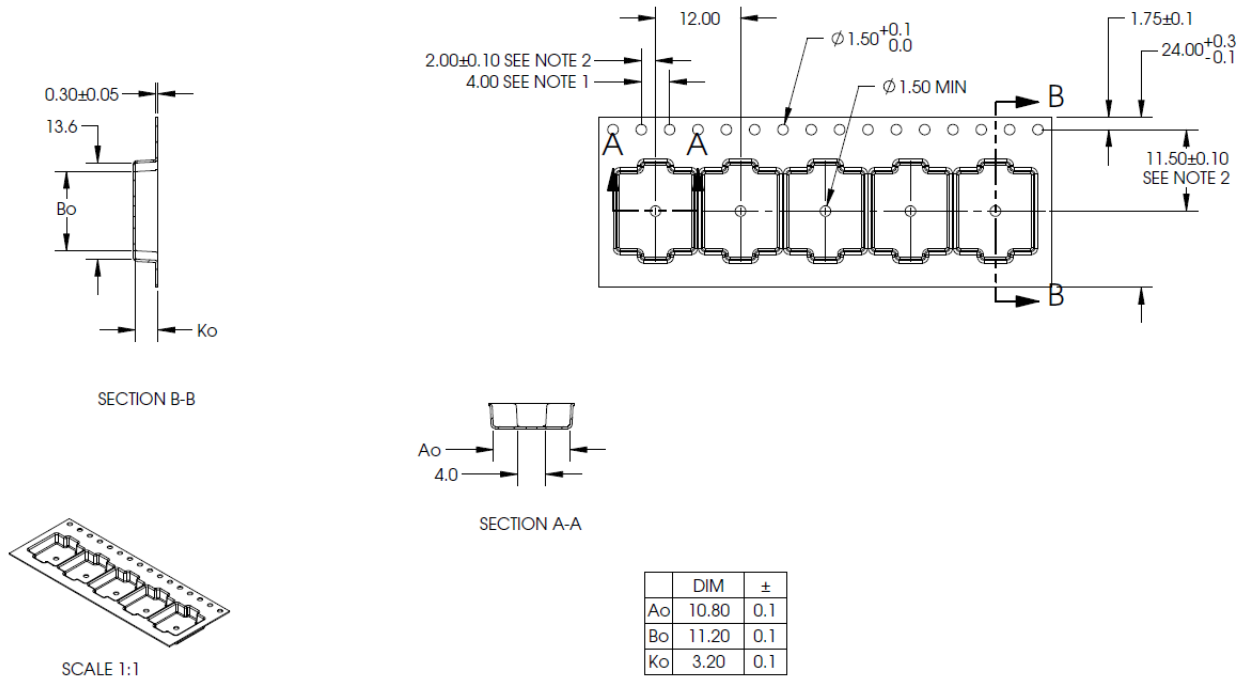
Figure 7 and Figure 8 shows the position and orientation of the NINA-W10 modules as they are delivered on tape. The dimensions of the tapes are specified in Figure 9 and Figure 10.



Figure 7: Orientation of NINA-W101 module on tape

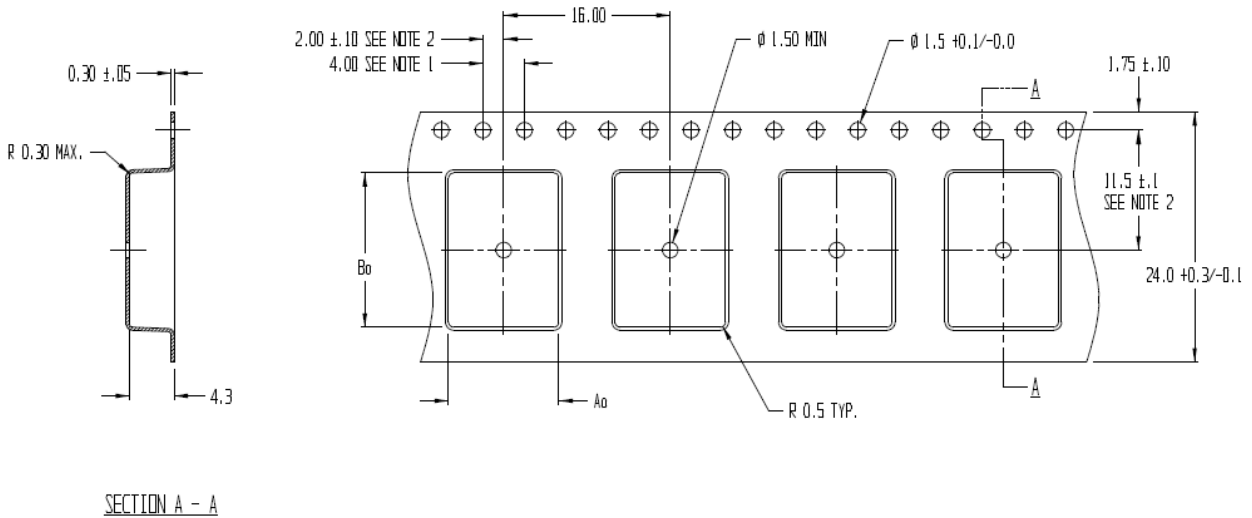


Figure 8: Orientation of NINA-W102 module on tape



- NOTES:
1. 10 SPROCKET HOLE PITCH CUMULATIVE TOLERANCE ±0.2
 2. POCKET POSITION RELATIVE TO SPROCKET HOLE MEASURED AS TRUE POSITION OF POCKET, NOT POCKET HOLE.
 3. Ao AND Bo ARE MEASURED ON A PLANE AT A DISTANCE "R" ABOVE THE BOTTOM OF THE POCKET.


Figure 9: NINA-W101 tape dimension




- NOTES:
1. 10 SPROCKET HOLE PITCH CUMULATIVE TOLERANCE ±0.2
 2. POCKET POSITION RELATIVE TO SPROCKET HOLE MEASURED AS TRUE POSITION OF POCKET, NOT POCKET HOLE
 3. Ao AND Bo ARE CALCULATED ON A PLANE AT A DISTANCE "R" ABOVE THE BOTTOM OF THE POCKET.

Figure 10: NINA-W102 tape dimension

8.2 Moisture sensitivity levels

-  The NINA-W10 series modules are Moisture Sensitive Devices (MSD) in accordance with the IPC/JEDEC specification.

The Moisture Sensitivity Level (MSL) relates to the required packaging and handling precautions. The NINA-W10 series modules are rated at MSL level 4. For more information regarding moisture sensitivity levels, labeling and storage, see the u-blox Package Information Guide [2].


-  For MSL standards, see IPC/JEDEC J-STD-020, which can be downloaded from www.jedec.org.

8.3 Reflow soldering

Reflow profiles are to be selected according to u-blox recommendations. See NINA-W1 Series System Integration Manual [1] for more information.

-  Failure to observe these recommendations can result in severe damage to the device.

8.4 ESD precautions

-  The NINA-W10 series modules contain highly sensitive electronic circuitry and are Electrostatic Sensitive Devices (ESD). Handling the NINA-W10 series modules without proper ESD protection may destroy or damage them permanently.

The NINA-W10 series modules are electrostatic sensitive devices (ESD) and require special ESD precautions typically applied to ESD sensitive components. Section 4.1.1 provides the maximum ESD ratings of the NINA-W10 series modules.

Proper ESD handling and packaging procedures must be applied throughout the processing, handling and operation of any application that incorporates the NINA-W10 series module. The ESD precautions should be implemented on the application board where the module is mounted as described in the NINA-W1 Series System Integration Manual [1].

-  Failure to observe these recommendations can result in severe damage to the device.

9 Labeling and ordering information

9.1 Product labeling

The labels (7.5 x 7.5 mm) of the NINA-W10 series modules include important product information as described in this section.

Figure 11 illustrates the label of all the NINA-W10 series modules, which includes product type number and revision, production date, Data Matrix with unique serial number and the u-blox logo.



Figure 11: Location of product type number on the NINA-W10 series module label

Reference	Description
1	Date of unit production encoded YY/WW (year, week)
2	Major and minor product version info
3	Product model name (NINA-W101 or NINA-W102)
4	Data Matrix with unique serial number of 19 alphanumeric symbols. The last 4 symbols represent the hardware and software version encoded HHFF.
5	u-blox logo. The red dot is also indicating pin no 1.

Table 22: NINA-W10 series label description

9.2 Explanation of codes

Three different product code formats are used. The **Product Name** is used in documentation such as this data sheet and identifies all u-blox products, independent of packaging and quality grade. The **Ordering Code** includes options and quality, while the **Type Number** includes the hardware and software versions. Table 23 below details these three different formats:

Format	Structure
Product Name	PPPP-TGVV
Ordering Code	PPPP-TGVV-TTQ
Type Number	PPPP-TGVV-TTQ-XX

Table 23: Product code formats

Table 24 explains the parts of the product code.

Code	Meaning	Example
PPPP	Form factor	NINA
TG	Platform (Technology and Generation) T – Dominant technology, For example, W: Wi-Fi, B: Bluetooth G – Generation	W1: Wi-Fi Generation 1
VV	Variant based on the same platform; range [00...99]	01: product with antenna pin
TT	Major Product Version	00: first revision
Q	Quality grade A: Automotive B: Professional C: Standard	B: professional grade
XX	Minor product version (not relevant for certification)	Default value is 00

Table 24: Part identification code

9.3 Ordering information

Ordering Code	Product
NINA-W101-00B	Module with antenna pin. Open CPU version.
NINA-W102-00B	Module with internal onboard antenna. Open CPU version.

Table 25: Product ordering codes

Appendix

A Glossary


Abbreviation	Definition
ADC	Analog to Digital Converter
BLE	Bluetooth low energy
BPF	Band Pass Filter
BR/EDR	Basic rate/Enhanced data rate
BT	Bluetooth
CAN	Controller Area Network
CTS	Clear To Send
DAC	Digital to Analog Converter
DC	Direct Current
DSR	Data Set Ready
DTR	Data Terminal Ready
ESD	Electro Static Discharge
FCC	Federal Communications Commission
GATT	Generic ATtribute profile
GND	Ground
GPIO	General Purpose Input/Output
I	Input (means that this is an input port of the module)
I ² C	Inter-Integrated Circuit
IC	Industry Canada
IEEE	Institute of Electrical and Electronics Engineers
IoT	Internet of Things
L	Low
LPO	Low Power Oscillator
MCU	Micro Controller Unit
MDIO	Management Data Input / Output
MII	Media-Independent Interface
MIMO	Multi-Input Multi-Output
MRD	Market Requirement Document
MSD	Moisture Sensitive Device
N/A	Not Applicable
O	Output (means that this is an output port of the module)
PCN	Product Change Notification
PIFA	Planar Inverted F Antenna
PD	Pull-Down
PU	Pull-Up
QSPI	Quad Serial Peripheral Interface
RMII	Reduced Media Independent Interface
RTS	Request To Send
RXD	Receive Data
SDIO	Secure Digital Input Output
SDK	Software Development Kit

Abbreviation	Definition
SPI	Serial Peripheral Interface
TBD	To Be Defined
TXD	Transmit Data
UART	Universal Asynchronous Receiver/Transmitter

Table 26: Explanation of the abbreviations and terms used

Related documents

- [1] NINA-W1 series System Integration Manual, document number [UBX-17005730](#)
- [2] u-blox Package Information Guide, document number [UBX-14001652](#)
- [3] Espressif System ESP32 Datasheet, Version 2.1
- [4] NINA-W10 Declaration of Conformity, document number [UBX-18007184](#)
- [5] NINA-W10 series Product Summary, document number [UBX-17051775](#)

 For regular updates to u-blox documentation and to receive product change notifications, register on our homepage (www.u-blox.com).

Revision history

Revision	Date	Name	Comments
R01	5-Mar-2018	mwej, kgom	Initial release of the Data Sheet for NINA-W10 series with open CPU architecture. Refer to UBX-17006694 for information about NINA-W13 series.
R02	19-Apr-2018	mlju, kgom	Updated the ordering codes (Table 25).
R03	5-Jun-2018	mwej, ovik, mlju, kgom	Added Bluetooth Qualification information (section 6.11). Updated Mac addresses (section 1.8). Updated Table 5 and section 6.
R04	4-Jan-2019	mwej, kgom	Removed "pending" status for Japan and Korea (section 6.1). Updated label description (Table 22). Updated Bluetooth qualification information (section 6.11). Updated SPI data signals naming to MOSI/MISO (section 3.1). Added information about UART2 (section 2.7.1). Removed LPO functionality. In chapter 4, updated RF characteristics.
R05	8-Aug-2019	mwej	Corrected LPO functionality information (moved LPO_IN signal from pin 5 to pin 7). Added certification information for Brazil, Australia, New Zealand and South Africa (sections 6.7-6.9). Updated information about approved antennas (chapter 7). Updated with RoHS 3 compliance (section 6.2.2). Updated voltage supply range (section 4.2.2) and Absolute maximum module supply voltage and maximum RF input ratings (section 4.1). Updated maximum ESD ratings (section 4.1.1). Corrected Wi-Fi typical output power in sections 1.3 and 1.6 (matching Wi-Fi radio characteristics section). Updated Bluetooth output power and sensitivity (sections 4.2.8 and 4.2.9).

Contact

For complete contact information, visit us at www.u-blox.com.

u-blox Offices

North, Central and South America

u-blox America, Inc.

Phone: +1 703 483 3180
E-mail: info_us@u-blox.com

Regional Office West Coast:

Phone: +1 408 573 3640
E-mail: info_us@u-blox.com

Technical Support:

Phone: +1 703 483 3185
E-mail: support@u-blox.com

Headquarters

Europe, Middle East, Africa

u-blox AG

Phone: +41 44 722 74 44
E-mail: info@u-blox.com
Support: support@u-blox.com

Asia, Australia, Pacific

u-blox Singapore Pte. Ltd.

Phone: +65 6734 3811
E-mail: info_ap@u-blox.com
Support: support_ap@u-blox.com

Regional Office Australia:

Phone: +61 2 8448 2016
E-mail: info_au@u-blox.com
Support: support_ap@u-blox.com

Regional Office China (Beijing):

Phone: +86 10 68 133 545
E-mail: info_cn@u-blox.com
Support: support_cn@u-blox.com

Regional Office China (Chongqing):

Phone: +86 23 6815 1588
E-mail: info_cn@u-blox.com
Support: support_cn@u-blox.com

Regional Office China (Shanghai):

Phone: +86 21 6090 4832
E-mail: info_cn@u-blox.com
Support: support_cn@u-blox.com

Regional Office China (Shenzhen):

Phone: +86 755 8627 1083
E-mail: info_cn@u-blox.com
Support: support_cn@u-blox.com

Regional Office India:

Phone: +91 80 405 092 00
E-mail: info_in@u-blox.com
Support: support_in@u-blox.com

Regional Office Japan (Osaka):

Phone: +81 6 6941 3660
E-mail: info_jp@u-blox.com
Support: support_jp@u-blox.com

Regional Office Japan (Tokyo):

Phone: +81 3 5775 3850
E-mail: info_jp@u-blox.com
Support: support_jp@u-blox.com

Regional Office Korea:

Phone: +82 2 542 0861
E-mail: info_kr@u-blox.com
Support: support_kr@u-blox.com

Regional Office Taiwan:

Phone: +886 2 2657 1090
E-mail: info_tw@u-blox.com
Support: support_tw@u-blox.com