



User Guide

Kasa Smart Thermostatic Radiator Valve Starter Kit KE100 KIT

Contents

| | |
|--|----|
| About This Guide | 1 |
| Introduction | 2 |
| Appearance-Kasa Hub | 3 |
| Appearance-Thermostatic Radiator Valve | 4 |
| Install Your Device | 7 |
| Set Up Your Kasa Devices | 11 |
| Main Device Controls | 13 |
| Manage Device Settings | 25 |
| Voice & 3rd Party Support | 34 |
| Authentication | 38 |

About This Guide

This guide provides a brief introduction to Kasa Smart Thermostatic Radiator Valve Starter Kit and the Kasa Smart app, as well as regulatory information.

Please note that features of Kasa Smart Thermostatic Radiator Valve Starter Kit may vary slightly depending on the model and software version you have, and on your location and language. All images, steps, and descriptions in this guide are only examples and may not reflect your actual experience.

Conventions

In this guide, the following convention is used:

| Convention | Description |
|------------------|--|
| Teal | Key information appears in teal, including management page text such as menus, items, buttons and so on. |
| <u>Underline</u> | Hyperlinks are in teal and underlined. You can click to redirect to a website. |

More Info

- Specifications can be found on the product page at <https://www.tp-link.com>.
- Our Technical Support and troubleshooting information can be found at <https://www.tp-link.com/support/>.

Introduction

Kasa Smart Thermostatic Radiator Valve Starter Kit include a Kasa Smart Thermostatic Radiator Valve and a Kasa Smart IoT Hub.

Kasa Smart Thermostatic Radiator Valve provides superior temperature control precision from the moment it is installed. Get the exact temperature you set. Nothing more. Nothing less. Featuring a much faster reaction time than traditional radiator valves, restores the comfort temperature in no time.



Voice Control



Schedules



Frost Protection



Up to 32 Radiators



Ultra-Long Standby



Child Lock

- Voice Control - Hands-free control that syncs with Amazon Alexa, Google Assistant, or Siri ShortCuts.
- Schedule - Make sure it is as hot as you need with presets and schedules that suit your life.
- Frost Protection - Keep your pipes unfrozen and your house safe.
- Ultra-Long Standby - Works with IoT hub, promising longer battery life (over one year).
- Up to 32 Radiators - Each hub can connect and manage up to 32 radiators.

Appearance-Kasa Hub

With superior ultra-low-power performance, Kasa Hub connects wirelessly with compatible Kasa accessories. So you can easily control and monitor your home from anywhere. See the detailed explanation below:

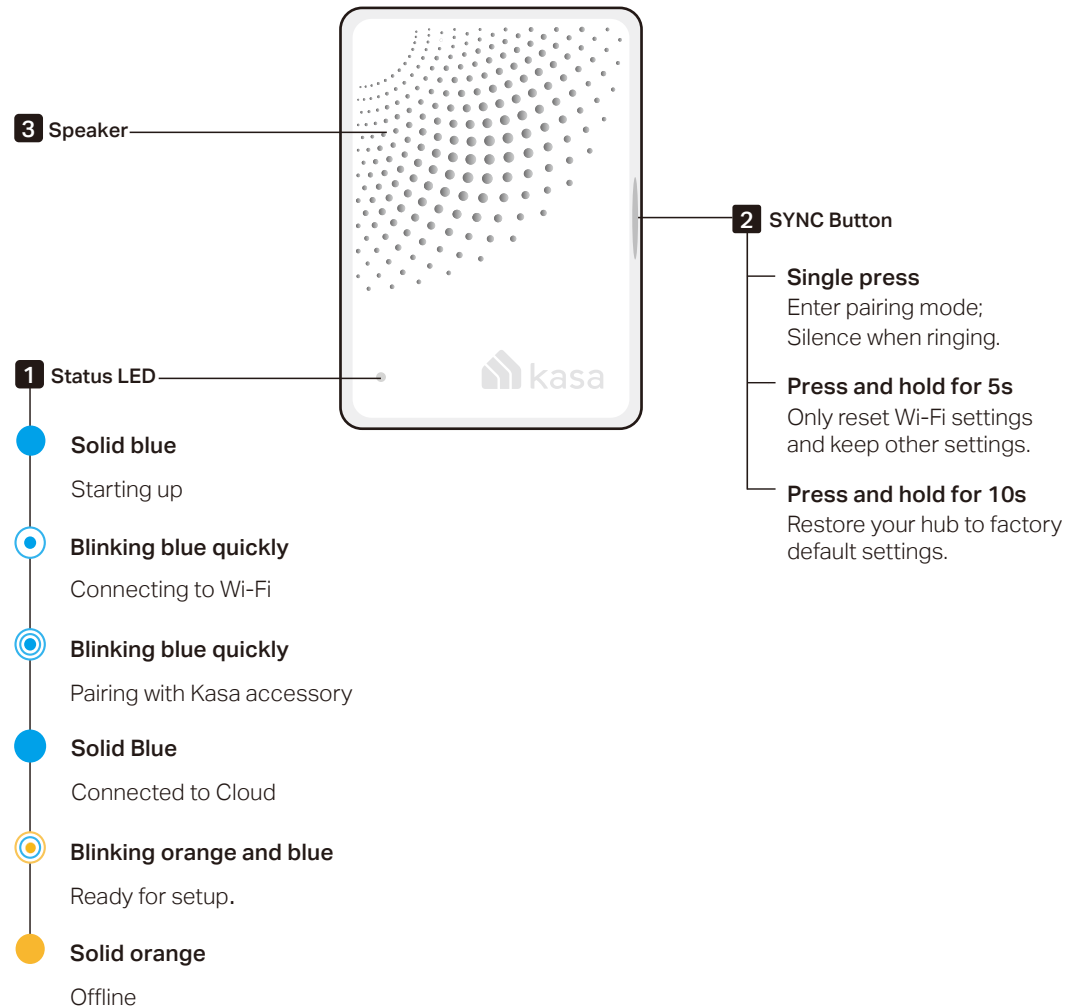



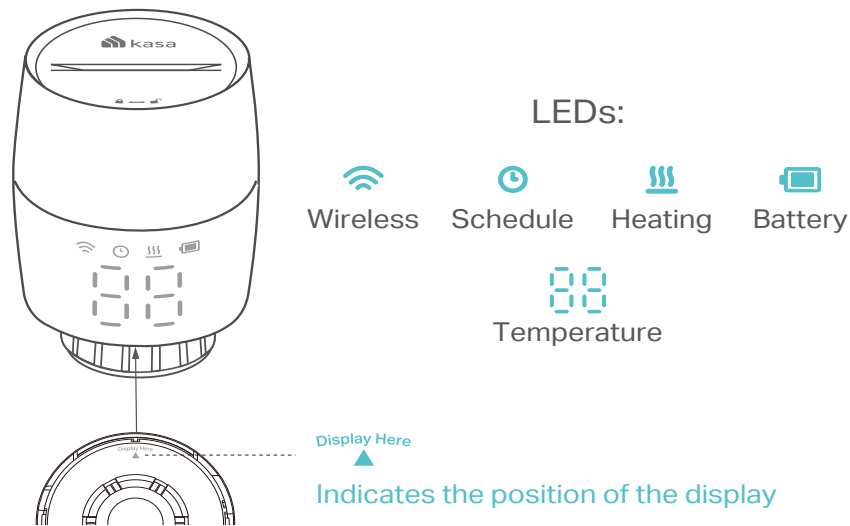

Appearance-Thermostatic Radiator Valve

The Kasa Smart Thermostatic Radiator Valve has LEDs to show you the current status of Wi-Fi, Schedule, Heating, Battery and Temperature. It also has a control knob for temperature adjustment and a SYNC/ RESET button. See the detailed explanation below:



LED Explanations

| LED | LED Status | Event |
|--|-----------------|--|
|  Wireless | Blinking slowly | Ready to be paired; Offline |
| | Blinking fast | Pairing; Device resetting |
| | Solid on | Pairing complete |
|  Schedule | Solid on | Adjust temperature based on your schedule |
|  Heating | Solid on | Raise temperature |
| | LED is off | Keep/lower temperature |
|  Battery | Blinking | Low battery |
| | Solid on | Sufficient battery power |

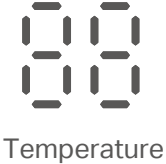
| LED | LED Status | Event |
|---|--|---|
|  | Blinking 88 twice, then blinking Hi, finally displaying normal temperature | Starting up |
| | Moving light, then displaying normal temperature | Calibrating |
| | Switching between cL and the normal temperature | Child lock enabled |
| | Switching between F, and the normal temperature | Frost protection |
| | Displaying Lo | Low battery: Valve can't work properly |
| | Displaying FF | Sleep mode |
| | Displaying E: | No valve detected or valve not compatible |
| | Displaying E2 | Valve blocked by calcification |

*You can rotate the LED display 180° in the Kasa Smart app.

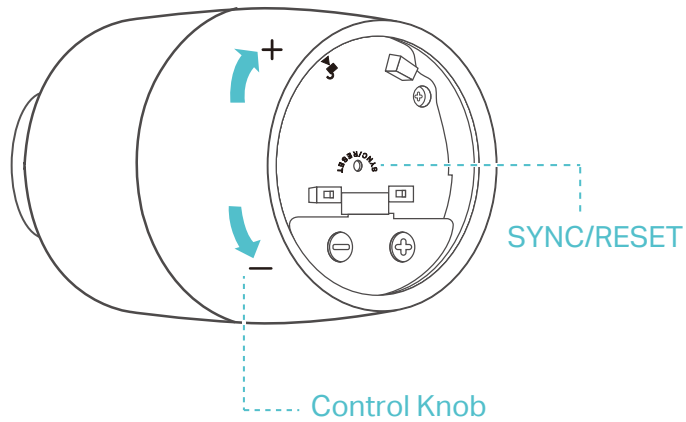

Button Explanations

| Button | Operation | Result |
|--------------|------------------------------|--|
| Control Knob | Rotate clockwise | Raise temperature. |
| | Rotate counterclockwise | Lower temperature. |
| | Rotate with no shown display | Activate the display. Then you can rotate to adjust the temperature. |
| SYNC/RESET | Press and hold for 5 seconds | Restore to factory default settings, and enter pairing mode. |

Compatible Batteries:

| Battery Type | Battery Voltage | Work Temp. |
|-------------------------|-----------------|------------|
| AA LR6 alkaline battery | 1.5V | 0°C-40°C |

Note: Do NOT use rechargeable batteries or 1.2V AA batteries.

Install Your Device

Follow the instructions below to install your Kasa Smart Thermostatic Radiator Valve.

01 / Check Compatibility

1. Check existing valve type

There are two types of valves: Thermostatic and Manual. Kasa Smart Thermostatic Radiator Valve is only compatible with the thermostatic valve.

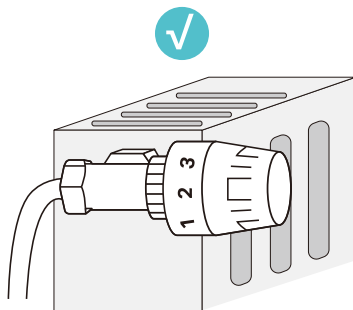

Thermostatic Valve

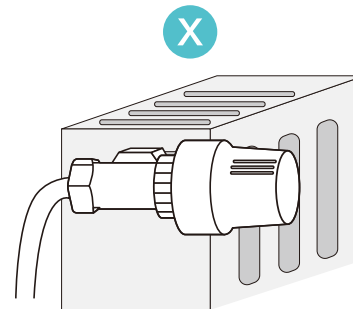

Manual Valve

Note: Manual valves are not compatible with Kasa Smart Thermostatic Radiator Valve, such as the ones in the following pictures.



2. Check the connector type

If your connector is M30 x 1.5, you can screw the new valve onto the radiator directly.

If not, check whether one of the provided adapters fits the connector. If none of them fit your connector, please purchase a proper one yourself.

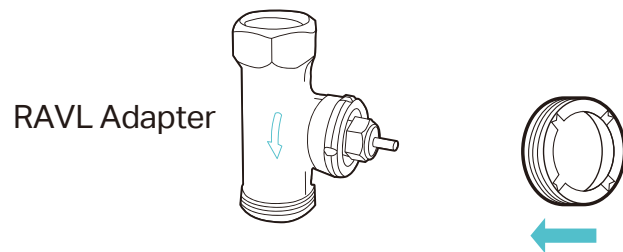
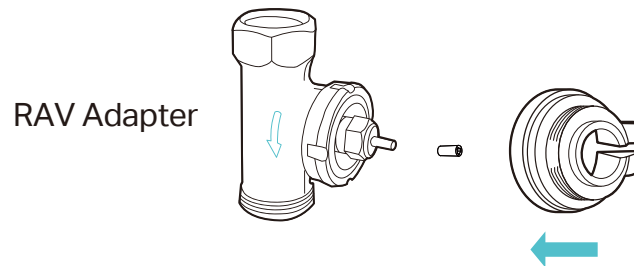
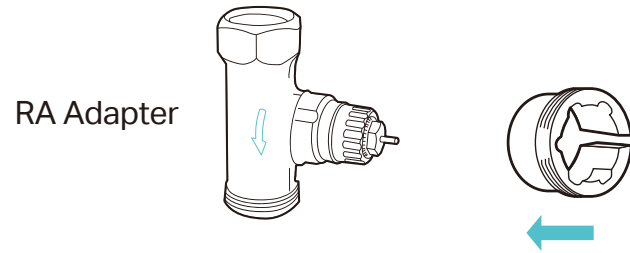
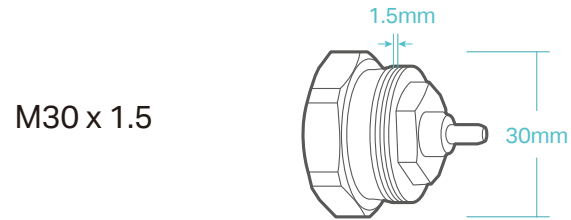

02 / Install Requirements

Read the following instructions first before installing the new valve:

1. Install the valve first before powering it up.
2. No need to shut off water before changing the radiator valve. Water will not leak.
3. Avoid installing the valve in the same room where you have installed the boiler thermostat.
4. Install the valve within range of your Kasa smart hub if you wish to control it using the Kasa Smart app.

03 / Install the Valve

1. Unscrew the existing valve.
2. Screw the new valve directly (for **M30 x 1.5** connector) or after installing the proper adapter (for non-M30 x 1.5 connectors). The ▲ at the bottom of the valve indicates the position of the display.

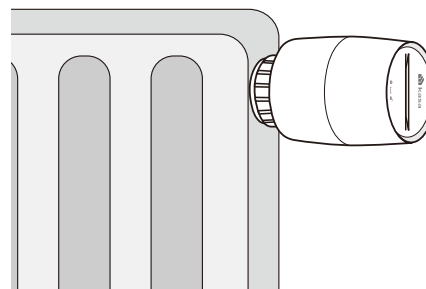
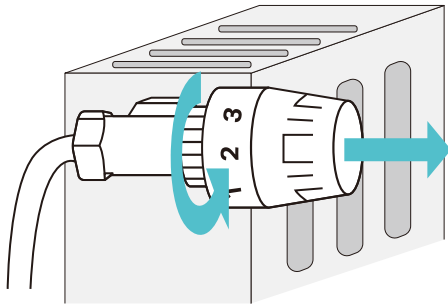

Horizontal Installation

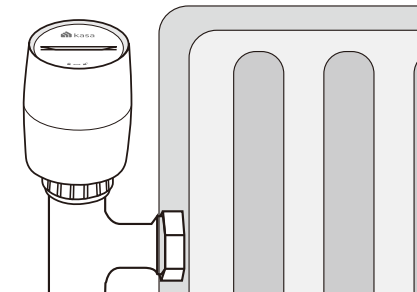

Vertical Installation

3. Remove the cover of the valve by rotating counterclockwise using the provided cover-opener.

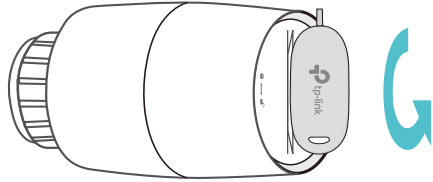

4. Open the battery cover and insert two AA LR6 Alkaline batteries. Make sure the positive and negative terminals face the correct direction.

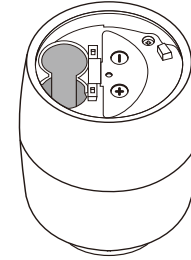

*Do NOT use rechargeable batteries or 1.2V AA batteries.

Note: you can still adjust temperature manually without a hub. After inserting the batteries, the valve is ready to use. Rotate the valve to increase / decrease temperature.

Set Up Your Kasa Devices

If you want to remotely control / manage the valve, you need to add a Kasa smart hub first.

Step 1 Download Kasa Smart App

Set up a Kasa smart hub in the Kasa Smart app if you haven't already done so. You can get the Kasa Smart app from the App Store or Google Play.



Step 2. Log In

Open the app, and log in with your TP-Link ID. If you don't have an account, create one first.

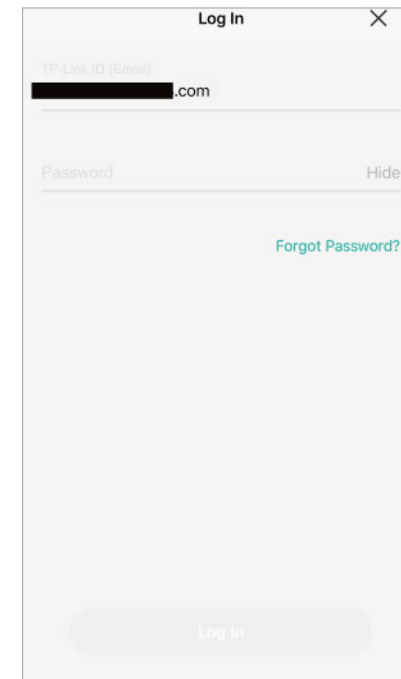

Step 3. Add Your Hub First

Tap the button in the app and select your model. Follow app instructions to set up your hub.

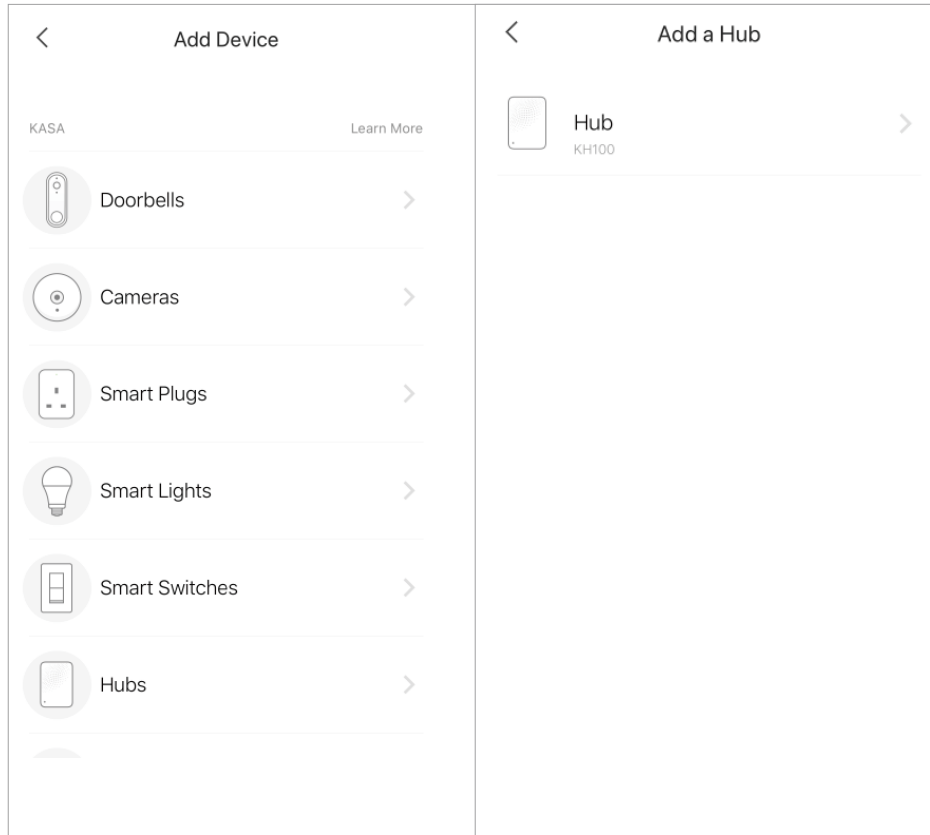

Step 4. Add Your Smart Thermostats Radiator Valve

Tap the + button and select your model. Follow the app instructions to pair the valve and complete setup.

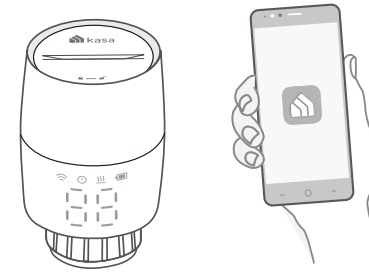

Main Device Controls

After you successfully set up your smart thermostatic radiator valve, you will see the home page of the Kasa Smart app. Here you can view and manage all devices that you've added to Kasa. Tap a smart thermostatic radiator valve to control and manage it.

Home Page

You can see all your Kasa devices listed in the Home page.

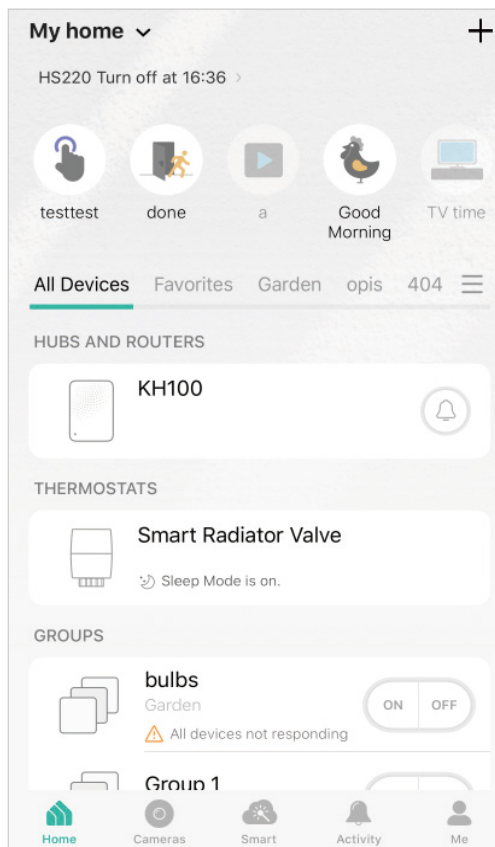

Turn on/off the smart thermostatic radiator valve

Turn on/off your smart thermostatic radiator valve quickly by tapping  on the device list. You can also achieve it on the status page.

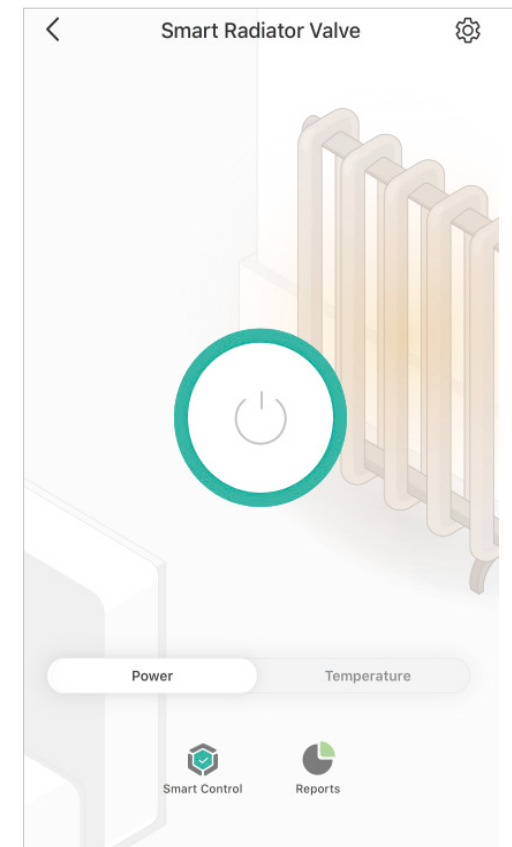
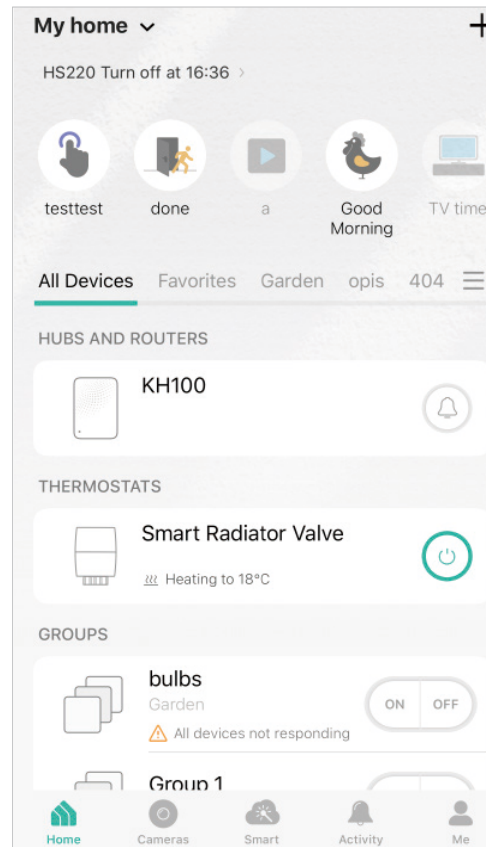

Increase/Decrease the heating temperature

You can check the current temperature and increase/decrease the heating temperature by dragging the point or tap - and +.

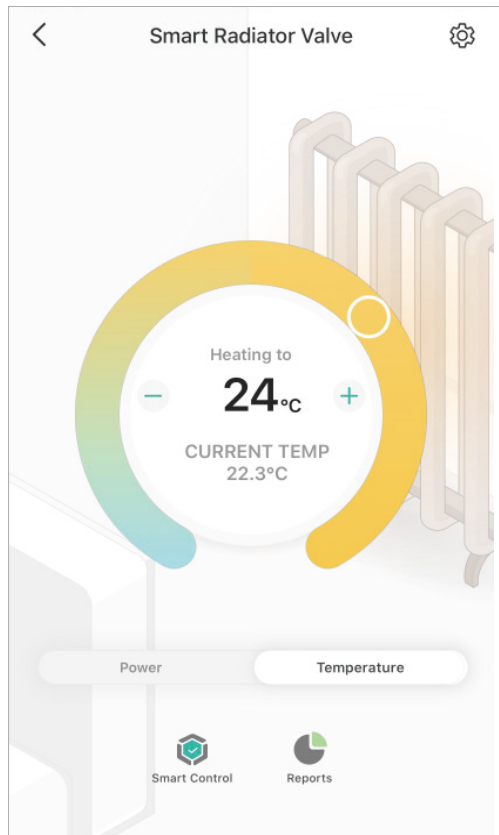

Smart Control

By setting up your own set of rules, turn on/off your radiator valve automatically to control the heating temperature according to your daily routine.

1. Tap your smart thermostatic radiator in the Home page, and then Tap  to set smart control rules.

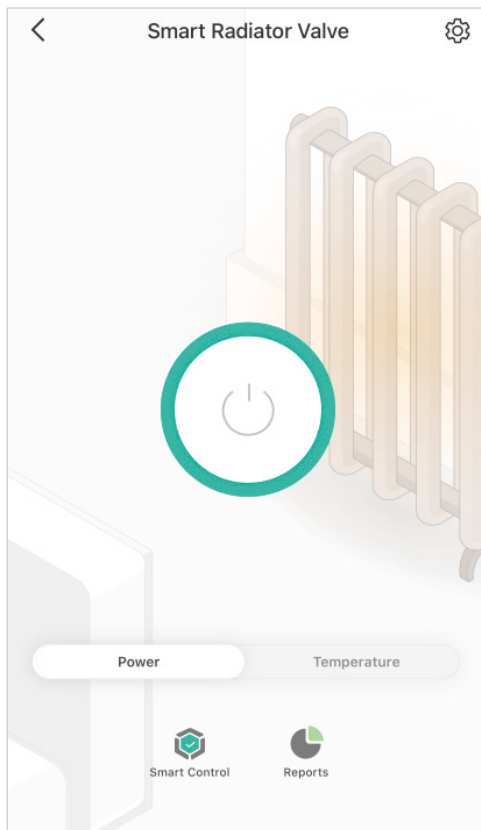

2. Turn on Smart Control and tap [Schedule Days](#).

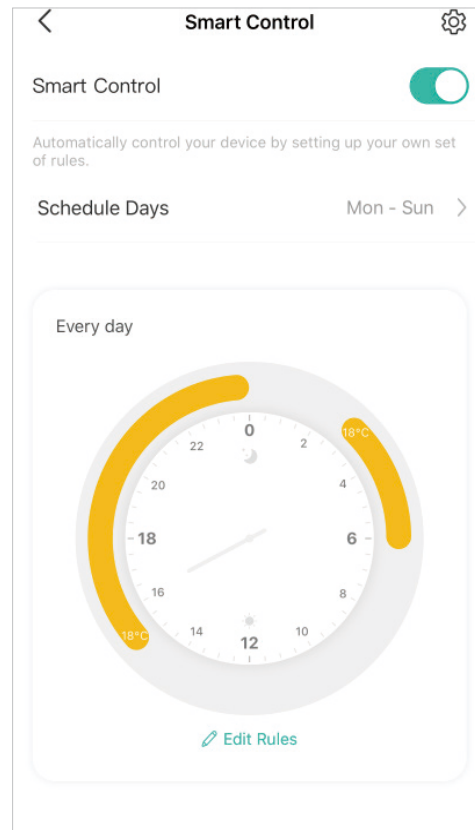

3. You can also choose day pattern for your smart control.

E.g. I want my smart thermostatic radiator valve to turn on and heat to the temperature of 25°C between 7:00 AM to 20:30 PM every weekday and 10°C for weekends. Here I should choose Mon - Fri, Sat, Sun.

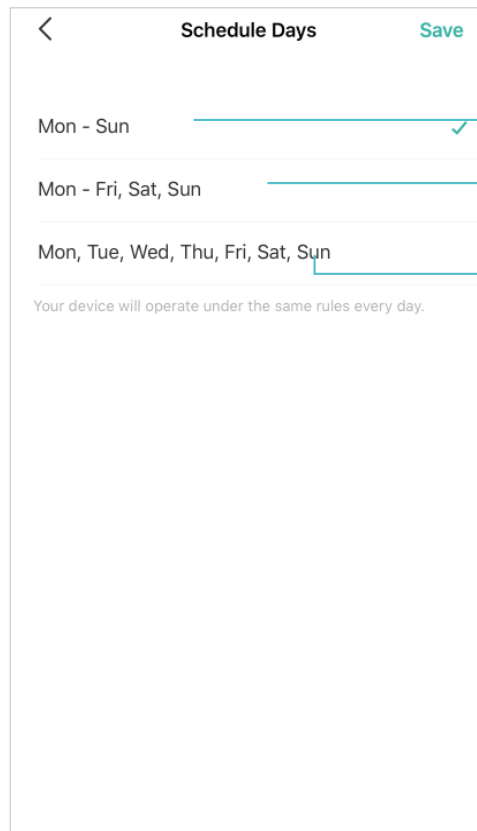

The screenshot shows a mobile application interface titled "Schedule Days". At the top left is a back arrow, and at the top right is a "Save" button. There are three radio button options for scheduling: "Mon - Sun", "Mon - Fri, Sat, Sun", and "Mon, Tue, Wed, Thu, Fri, Sat, Sun". The "Mon - Fri, Sat, Sun" option is selected, indicated by a teal checkmark. Below the options, a note reads "Your device will operate under the same rules every day."

Make your thermostatic radiator valve heat based on one set of rules every day.

Make your thermostatic radiator valve heat based on three sets of rules for weekdays, Saturday and Sunday respectively.

Make your thermostatic radiator valve heat based on different sets of rules for every day.

4. For the first set of schedule rules from Monday to Friday, tap [Edit Rules](#) and then [ADD RULE](#) to add an effective time for your Smart Control.

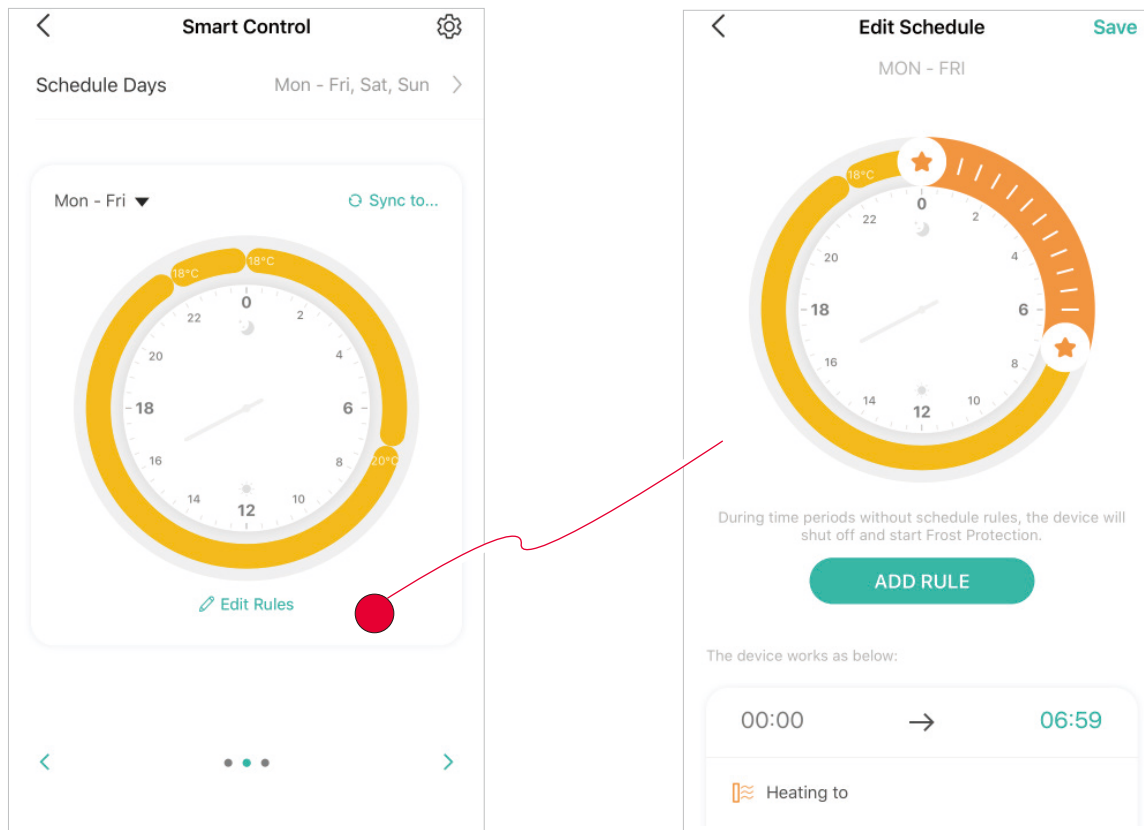

5. To adjust the time, you can drag the end points of the whole segment or simply roll down and set the time at the button of the page.

6. Set the heating temperature at the bottom of the page.

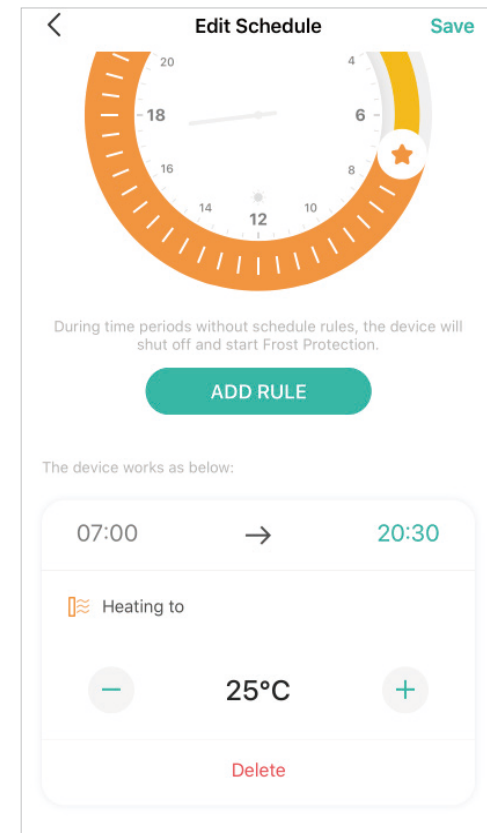
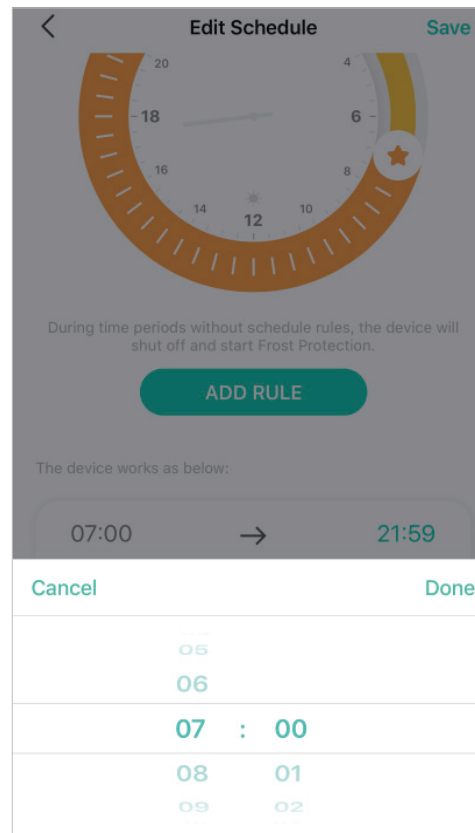
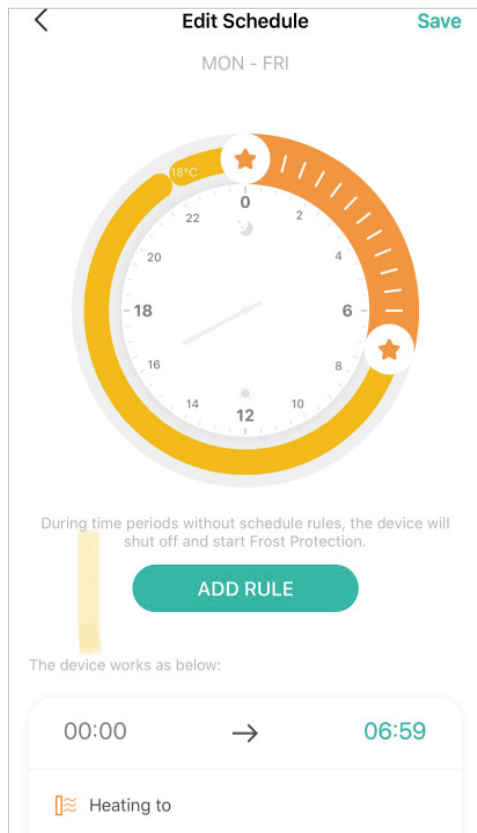

7. Tap **Save** and your smart thermostatic radiator valve will heat to 25°C from 7:00 am to 20:30 pm on weekdays.

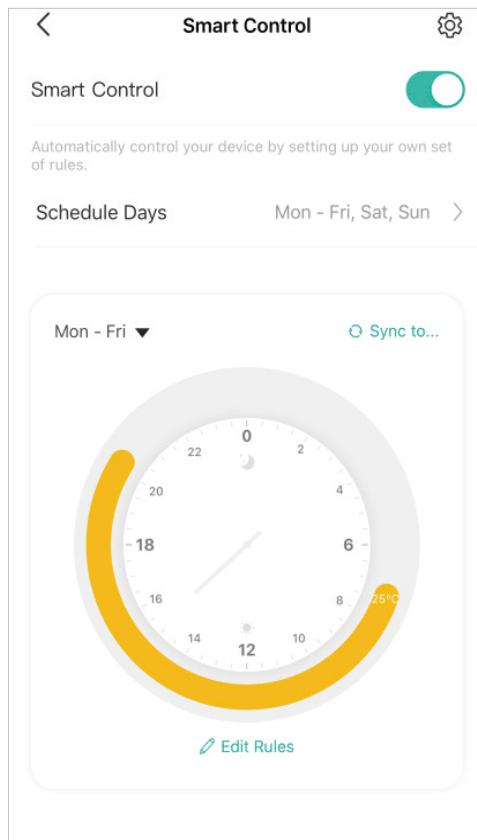

8. For second set of rules, swipe the page or tap ▼ to switch to the schedule setting for Saturday and repeat step 4 to 7 to set schedule rules.

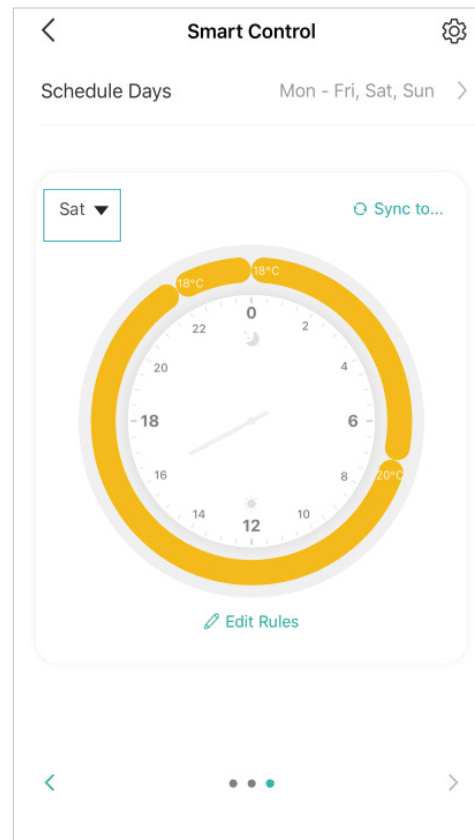

9. Repeat Step 4 to 8 to set schedule rules for Sunday.

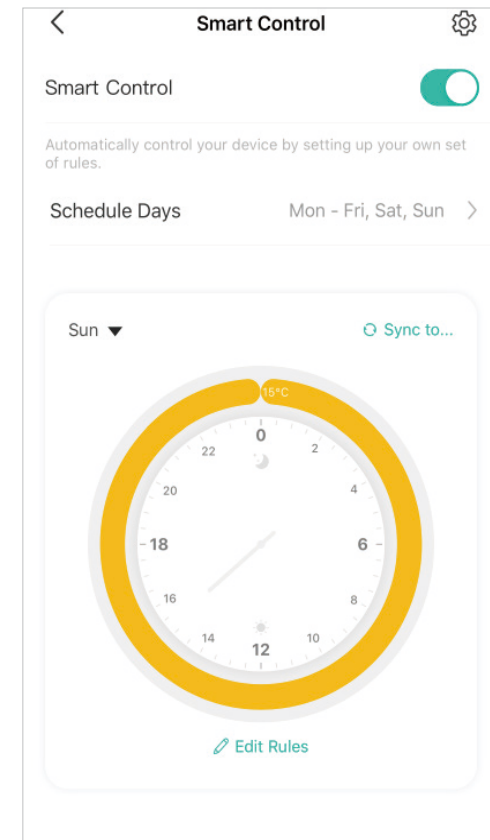

10. If you want to apply the just added rules to the other day, you can tap [Sync to....](#)

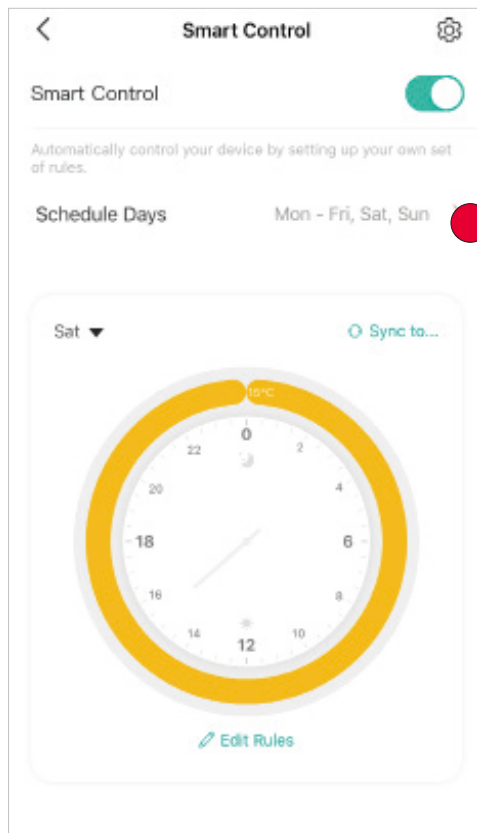

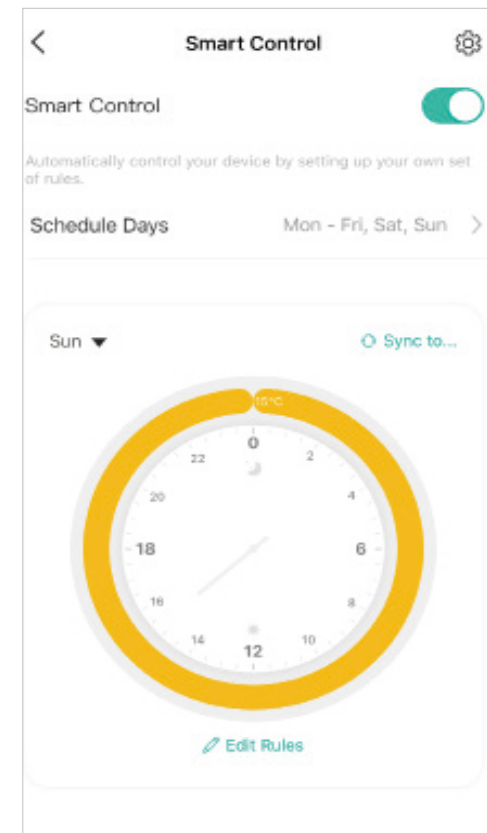
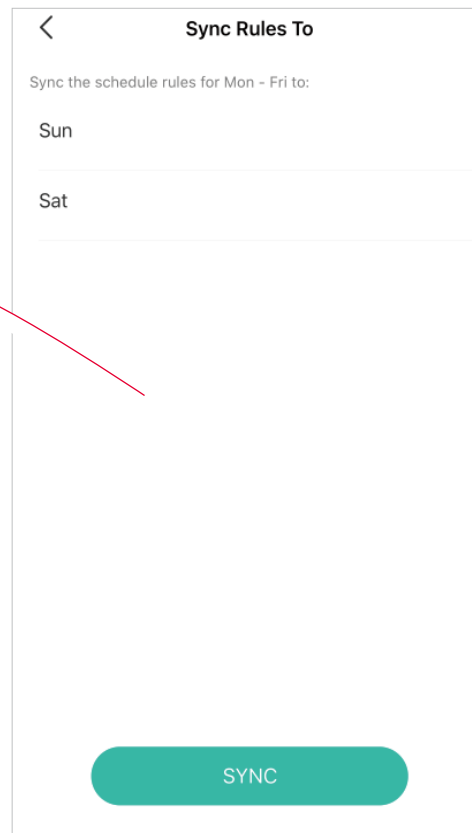

11. Choose the day you like and tap [SYNC](#) then the schedule rules can be sync to your chosen days.

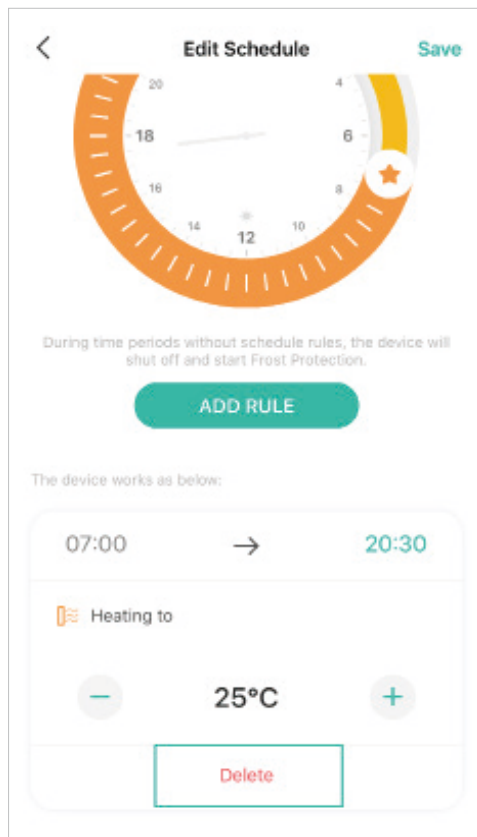

12. Delete Rules

Select the time period on the annulus and tap Delete at the button of the page.



13. If you want your room temperature reach your set one at the start of your schedule period, you can enable **Early Start**. Tap  and turn it on.

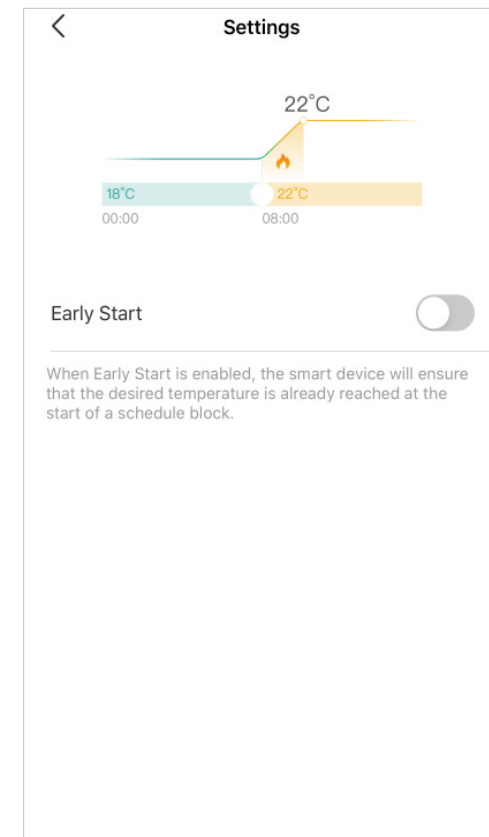
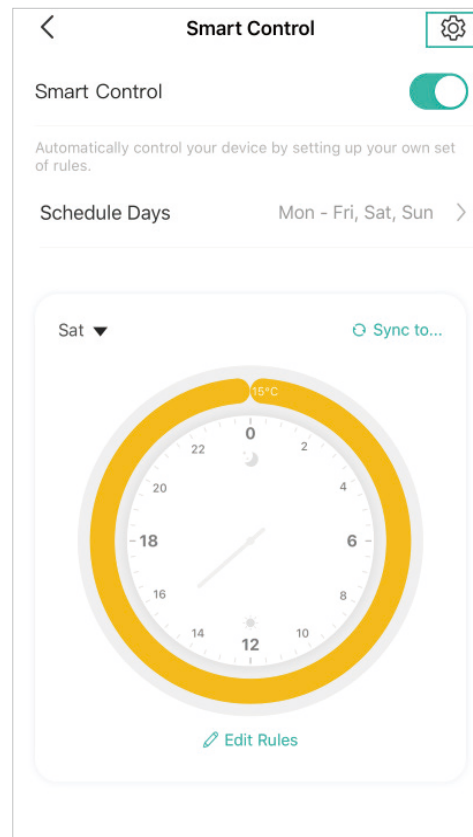

Reports

In the Report page, you can check your heating and temperature history and device runtime.

1. Tap  In the Device page, you can see the statistic of the day.

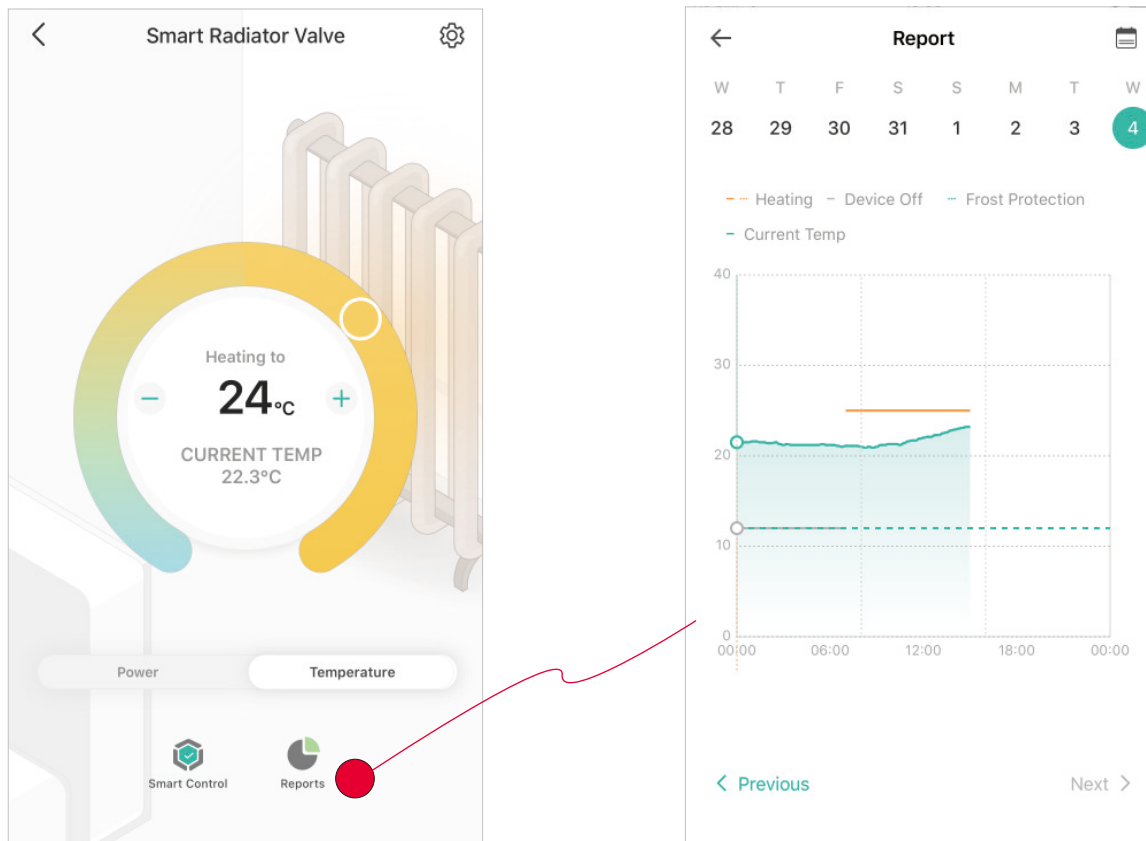

 Heating: Your set heating temperature

- **Solid Line:** the set heating temperature is higher than room temperature.
- **Dotted Line:** the set heating temperature is lower than room temperature.

 Device Off: When your device is off

 Frost Protection: The frost protection temperature.

 Current Temp: The current room temperature

2. Tap the line on the chart, then you can check the current temperature and heating temperature.

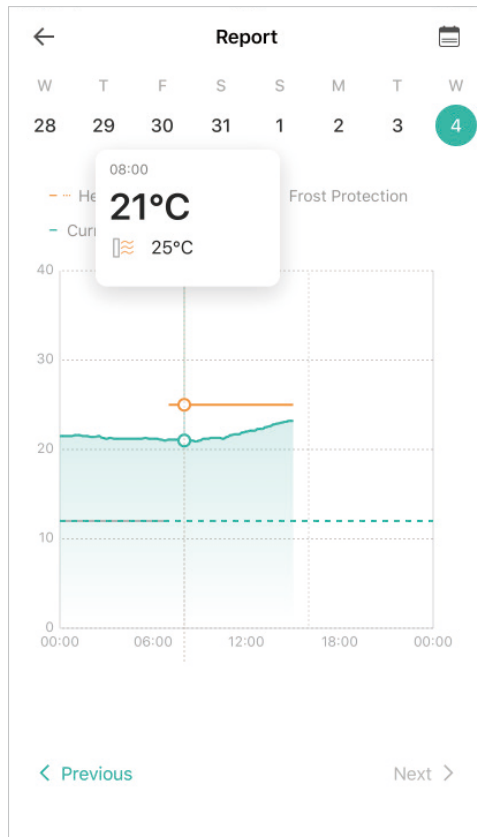

3. Tap **Previous** and **Next** or choose the date directly to shift to the day you want to check.

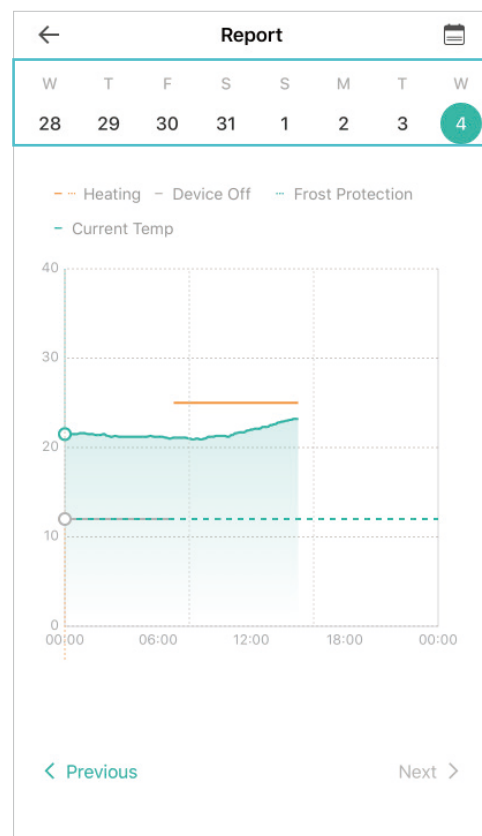

Swipe left or right to choose the date you want to check.

4. Tap  to check the total heating time when the room temperature is lower than the set temperature, which is shown with yellow block. If you want more information, just tap the date to see more in the chart.

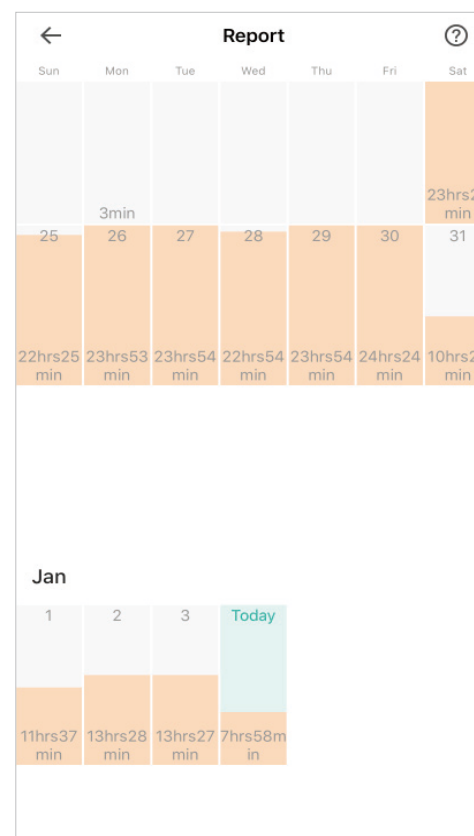

Manage Device Settings

Change Device Icon

Tap  and then choose a [Device Icon](#) you like.

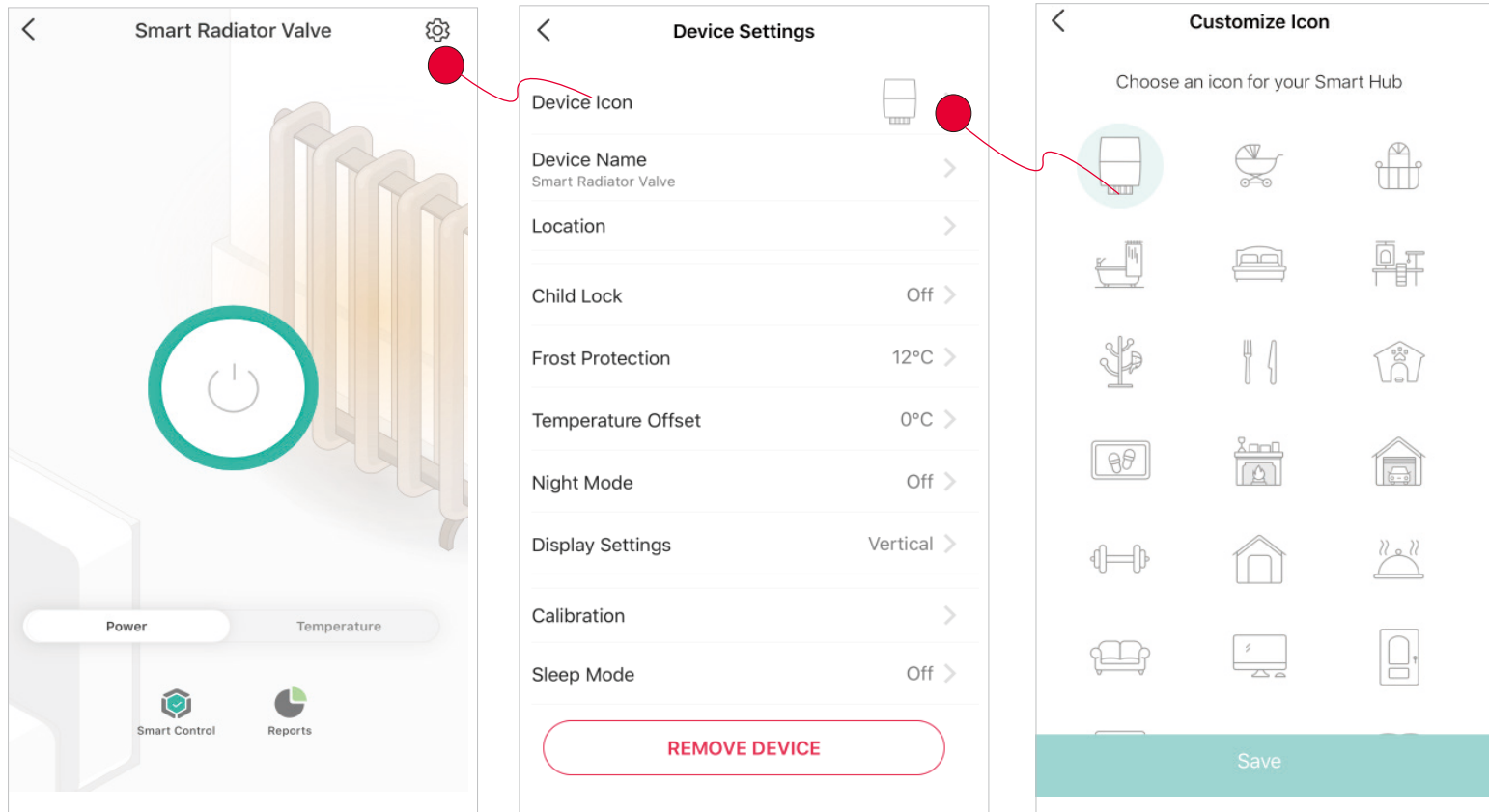

Change Device Name

Tap [Device Name](#) in Device Settings page to give your device a name.

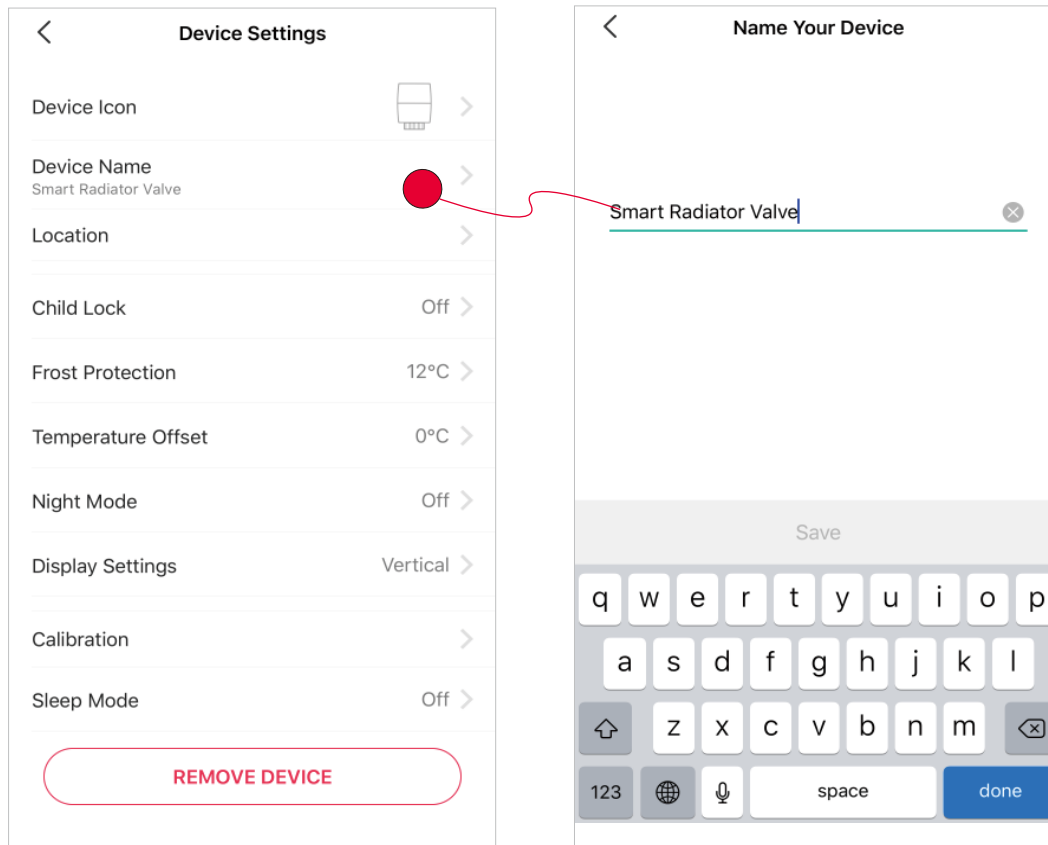

Change Device Location

Tap [Location](#) in Device Settings page to change your device location.

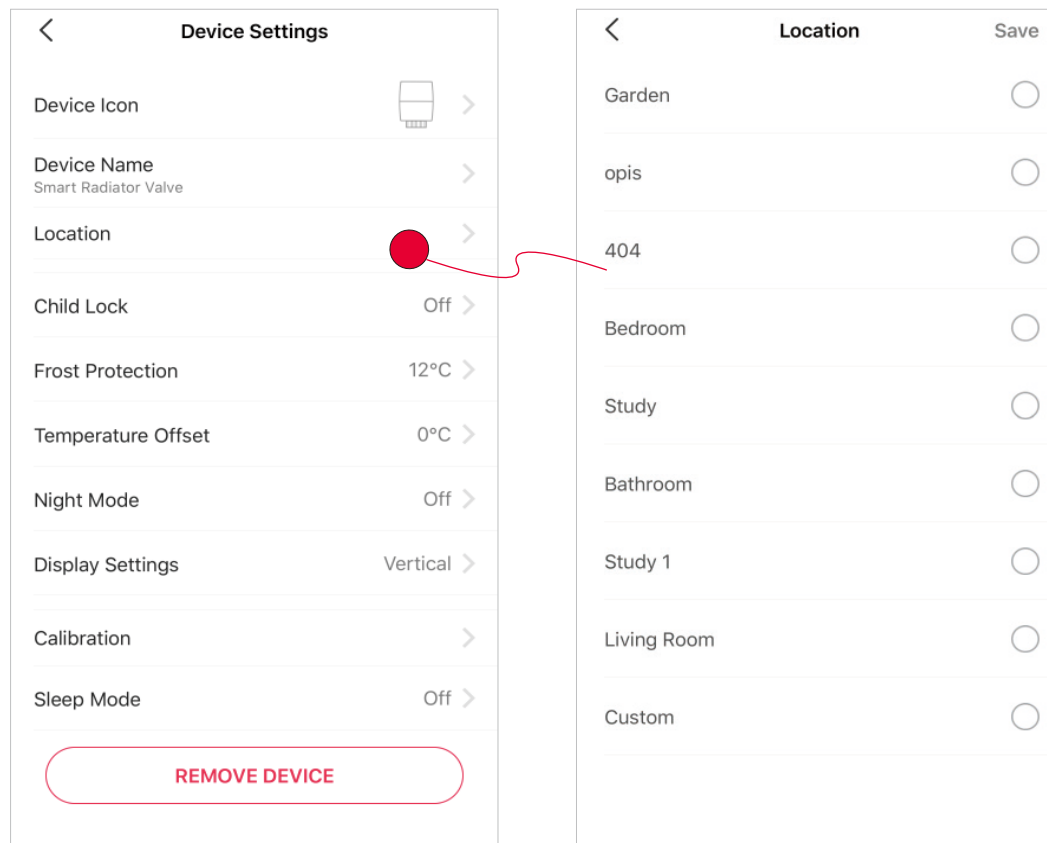

Child Lock

When enabled, the temperature can only be adjusted from the Kasa app or connected third-party services.
Tap [Child Lock](#) then turn on/off [Child Lock](#).

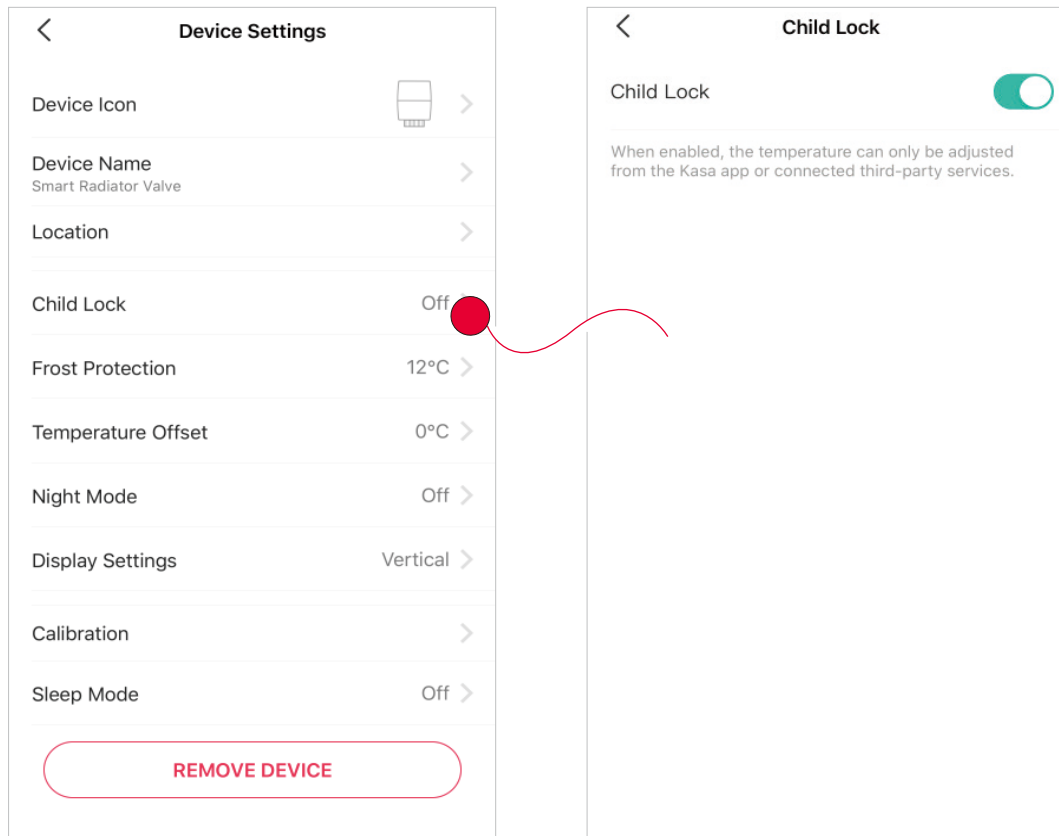

Frost Protection

Frost Protection ensures that the internal temperature of your radiator does not drop below your set temperature, thus protecting your pipes from freezing.

Tap [Frost Protection](#) and then set [Minimum Temperature](#).

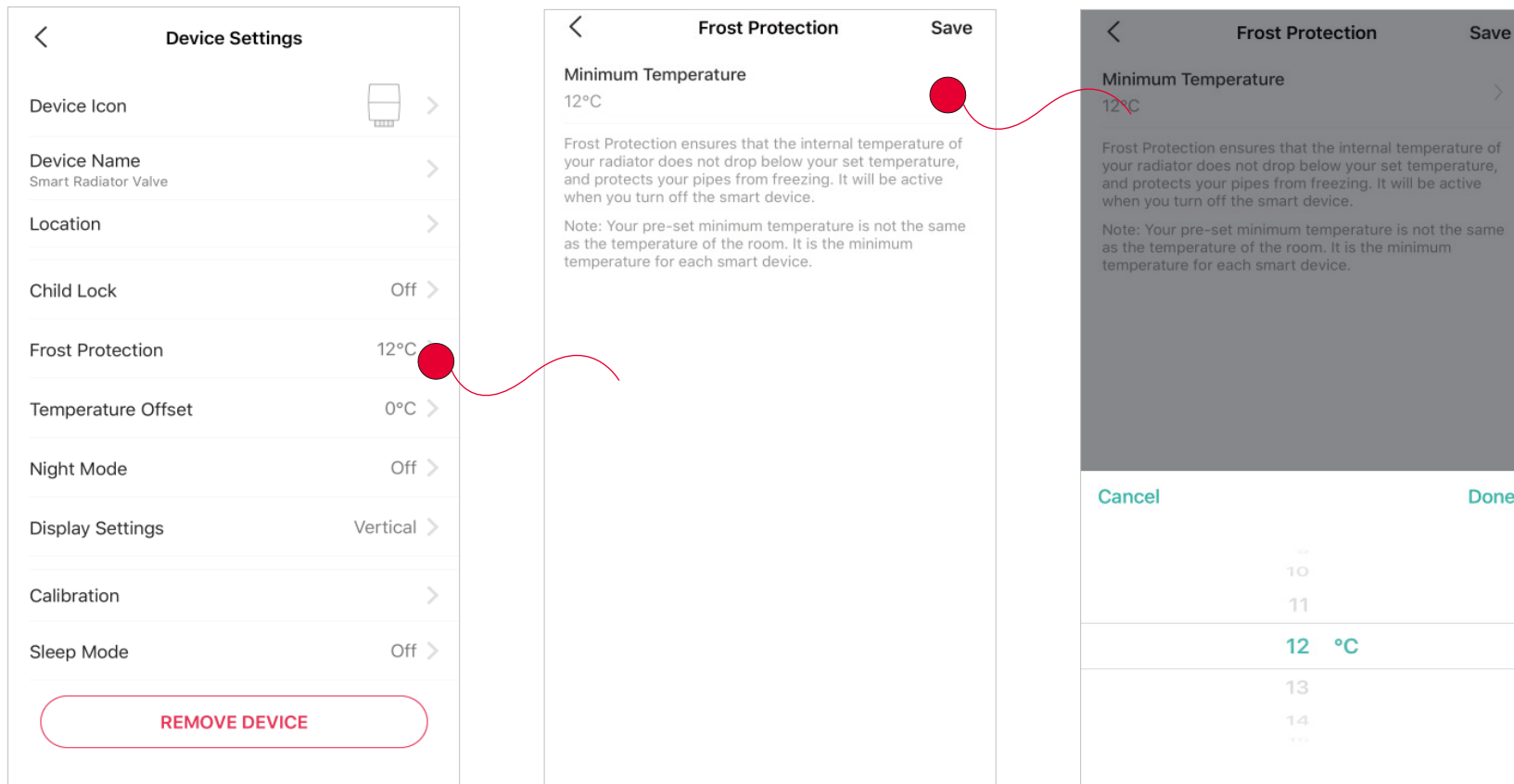

Night Mode

Tap [Night Mode](#) and turn it on to make your thermostatic radiator valve open and close less often to reduce the noise at night while still maintaining a proper temperature. Then tap [Effective Time](#) to set the time as you like.

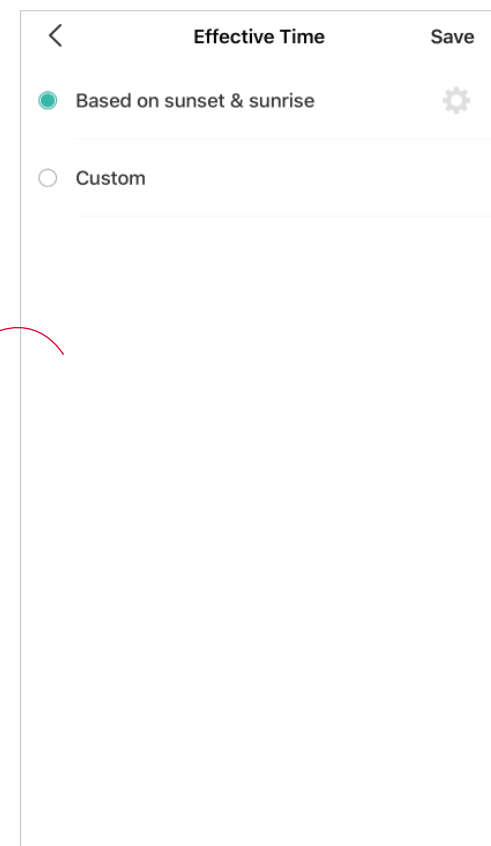
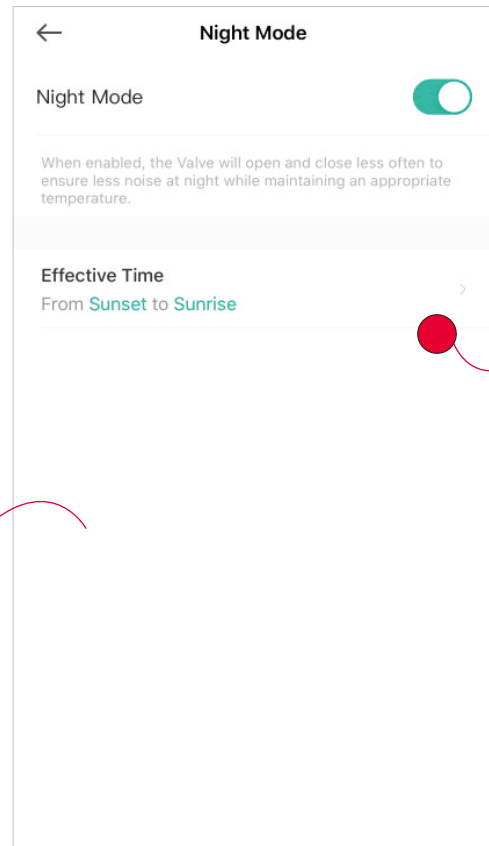
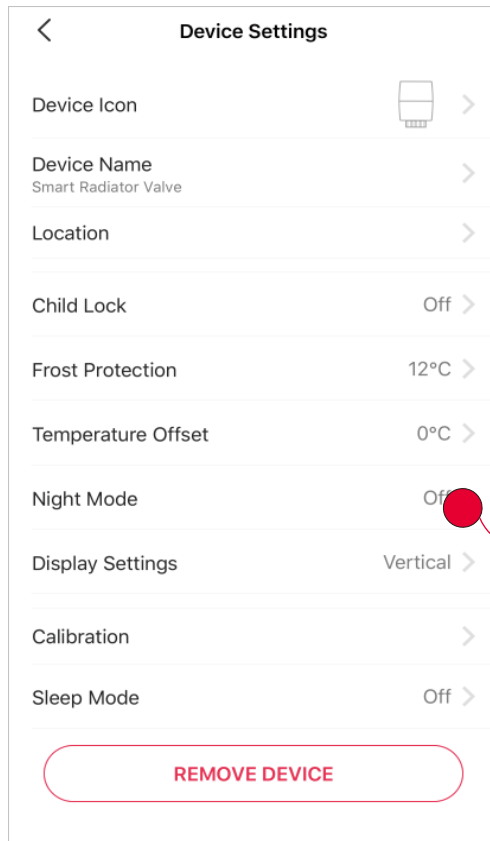

Display Settings

Tap [Display Setting](#) and choose the installation orientation between [Horizontal](#) and [Vertical](#). Your thermostatic radiator valve will adjust its display correspondingly.

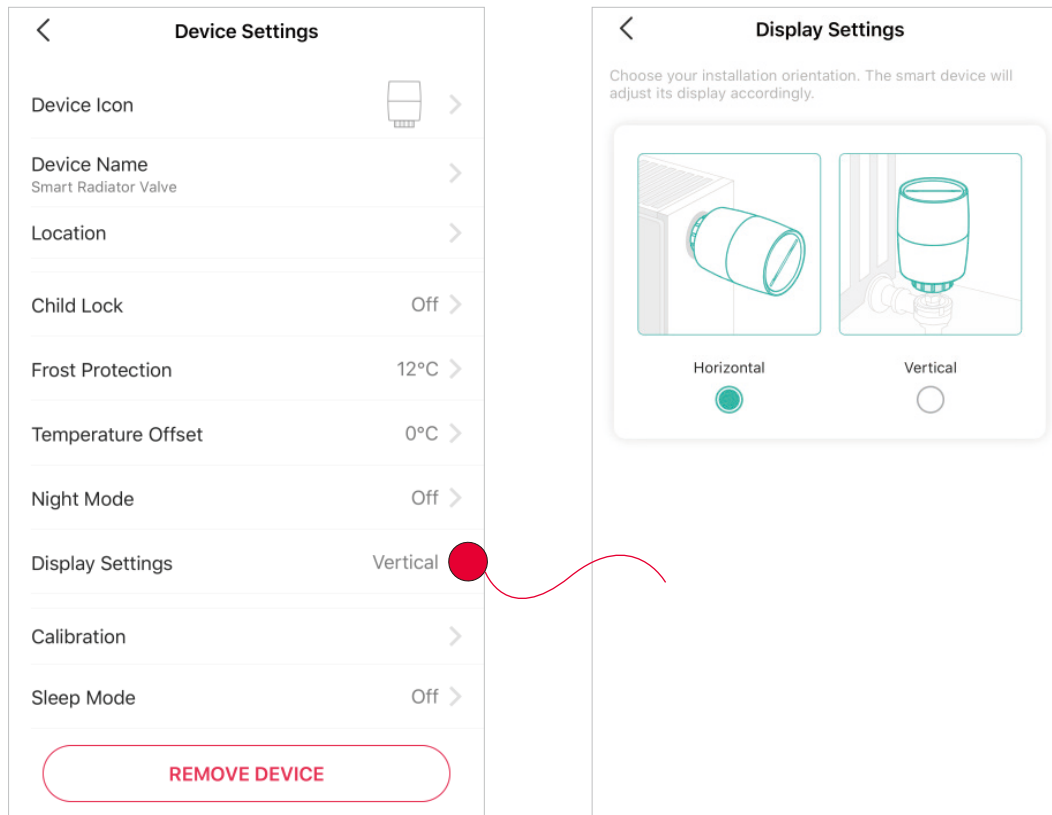

Calibration

It is recommended to calibrate your thermostatic radiator valve to determine the Open and Closed positions.

Note: During calibration, you cannot turn off the smart device or adjust the temperature.

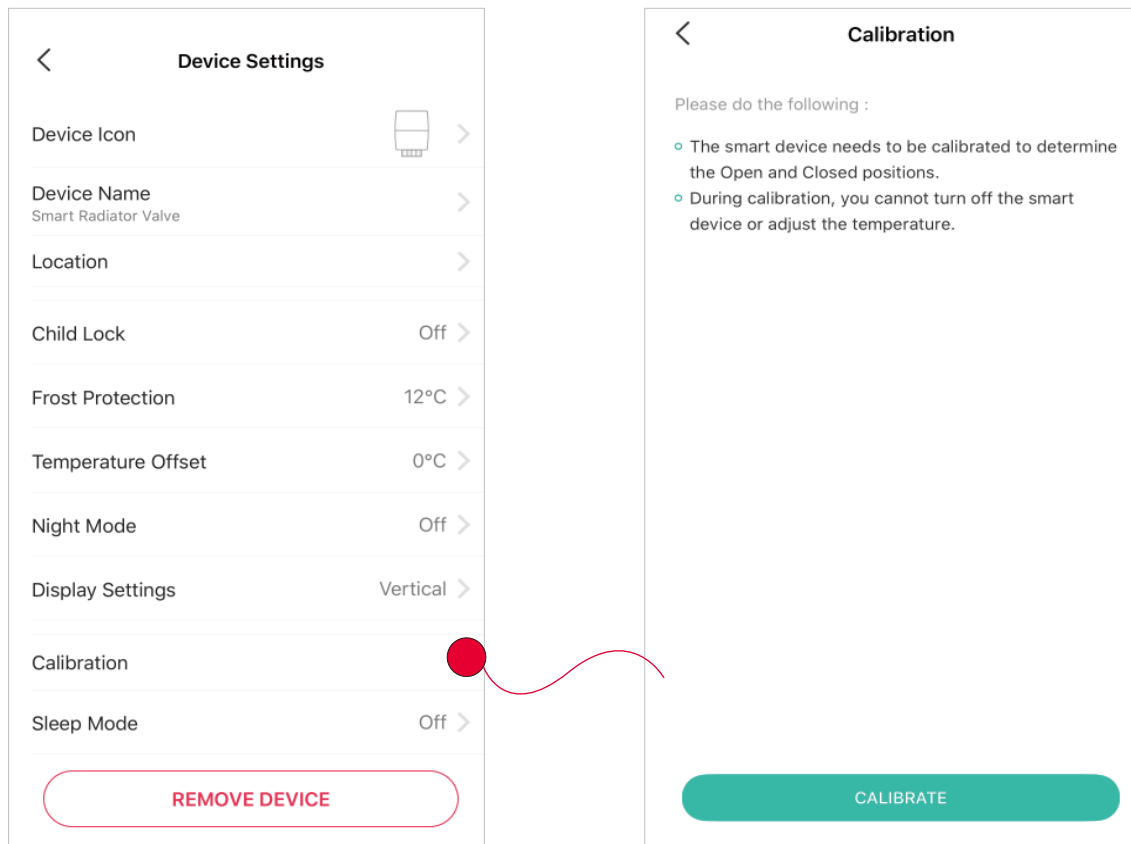

Sleep Mode

Tap [Sleep Mode](#) and configure its setting to save the battery power of your thermostat. When enabled, you will not be able to check or adjust the temperature.

Fully Closed: The valve will be fully closed.

Fully Open: The valve will be fully open.

Remove Device.

Tap your [REMOVE DEVICE](#) at the button to delete your device.

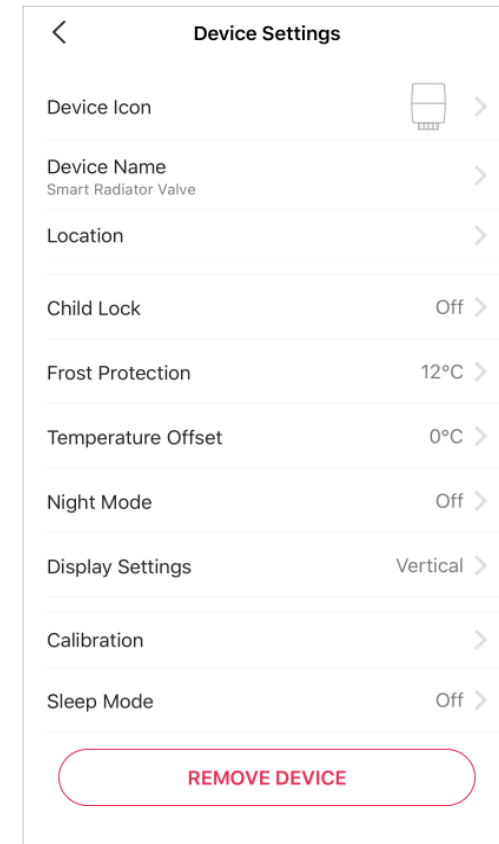
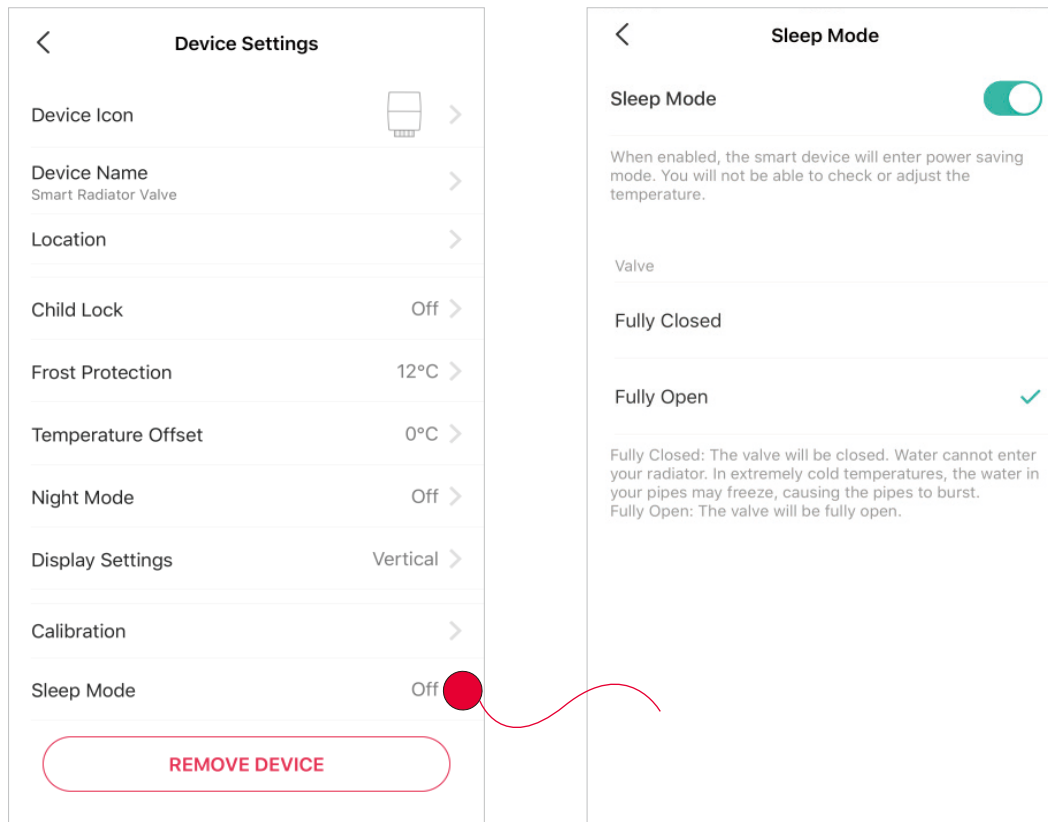

Voice & 3rd Party Support

Use the Kasa Smart app to pair your smart thermostatic radiator valve with Amazon Alexa or Google Home Assistant, and enjoy a full hands-free experience. Kasa helps manage the rest of your smart home too, working with Samsung SmartThings to trigger changes when you arrive home or leave for the day.

Launch the **Kasa Smart** app. Go to **Me** and tap **Third-Party Services**. You can choose **Amazon Alexa** / **Google Assistant** / **IFTTT** / **Samsung SmartThings** for detailed instructions.

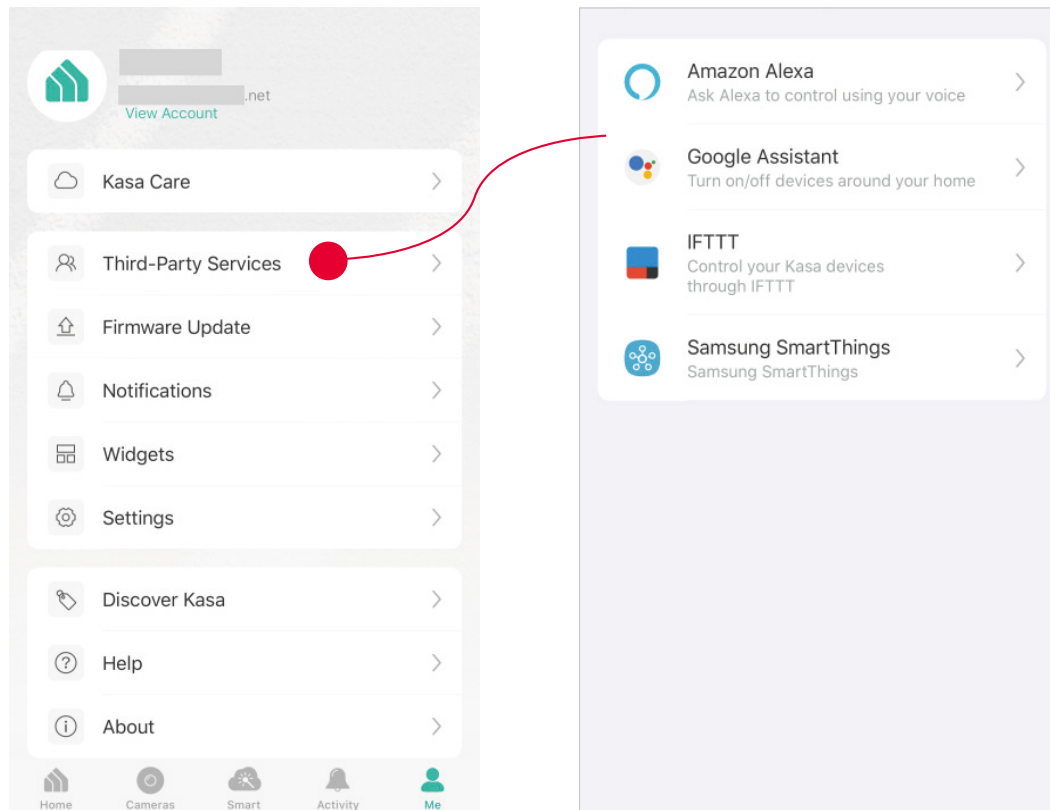

1. Set up Amazon Alexa

1. Tap [Amazon Alexa](#).

2. Tap [Connect](#).

3. Sign in with your amazon account.

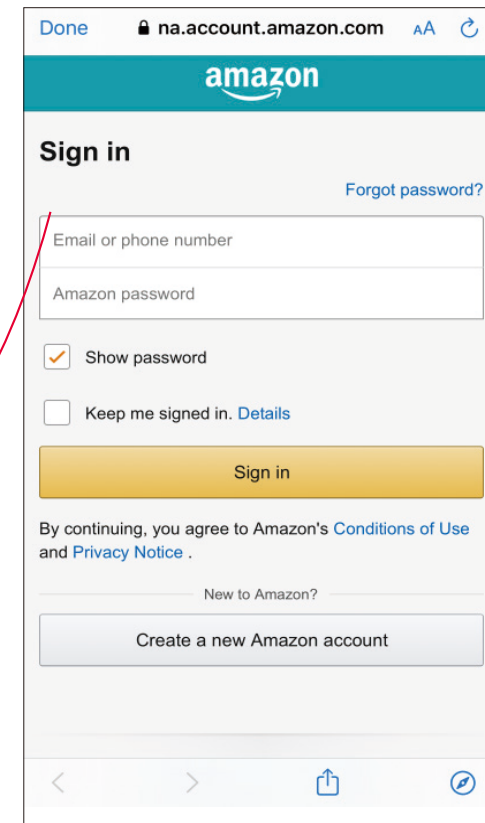
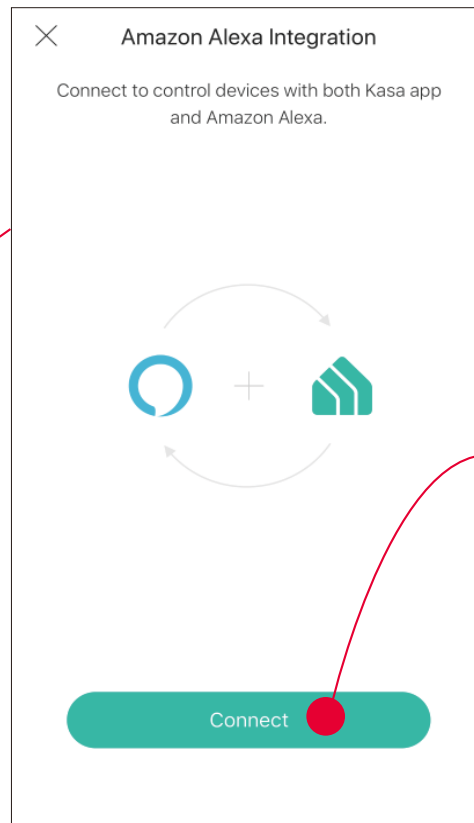
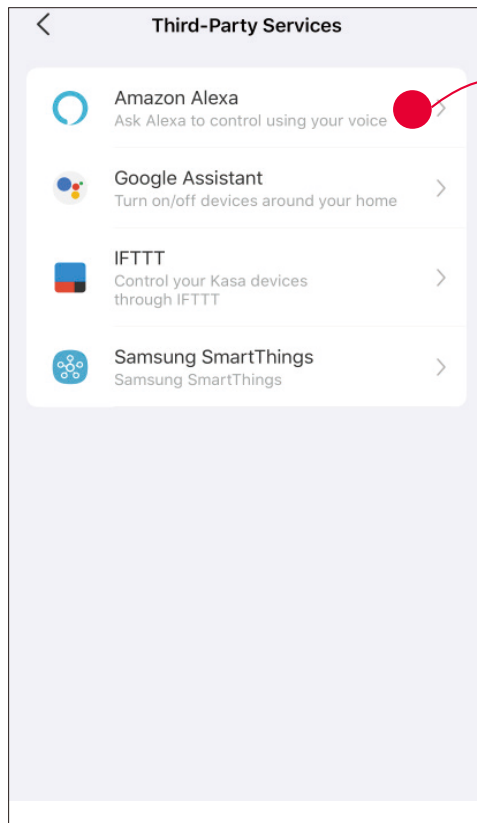

3. After sign-in, tap [LINK](#).

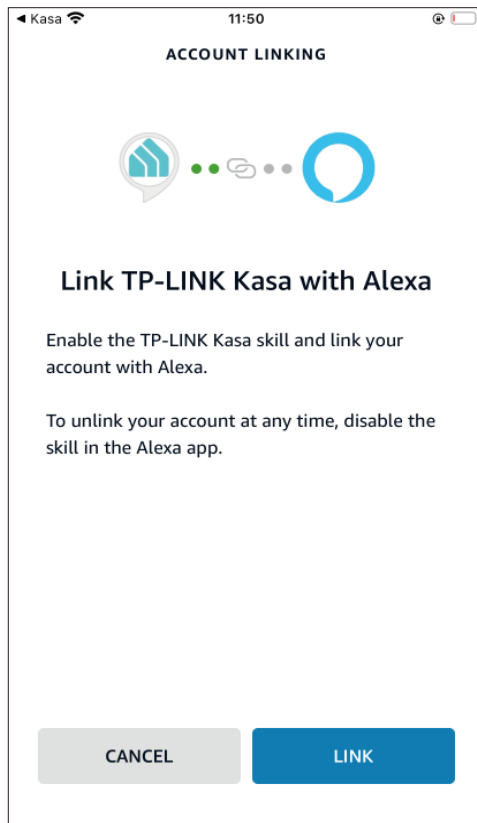

4. Your TP-Link ID has been successfully linked with your amazon account. You can use Alexa voice commands to control your Smart Wi-Fi Power Strip.

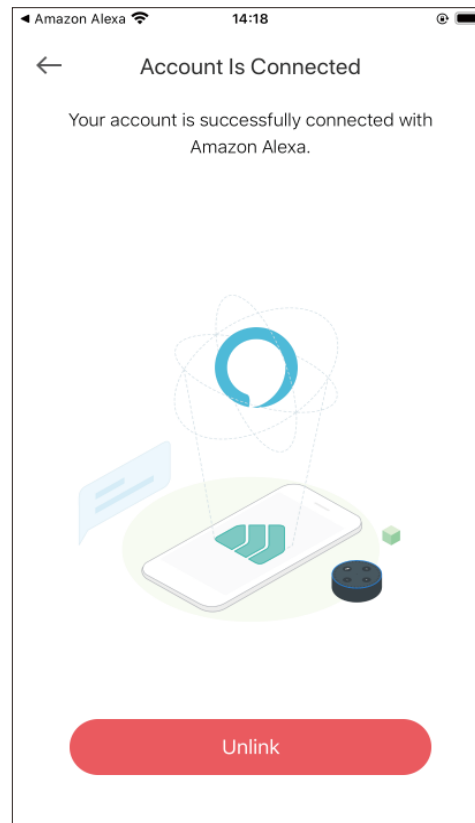

2. Set up Google Assistant

1. Tap [Google Assistant](#).

2. Follow instructions to connect your device to your Google Home.

Or find the FAQ at <https://www.tp-link.com/en/support/faq/1534/>.

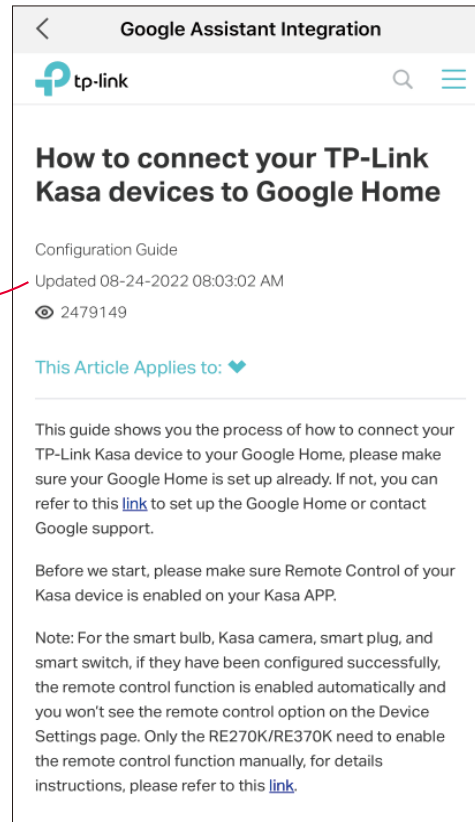
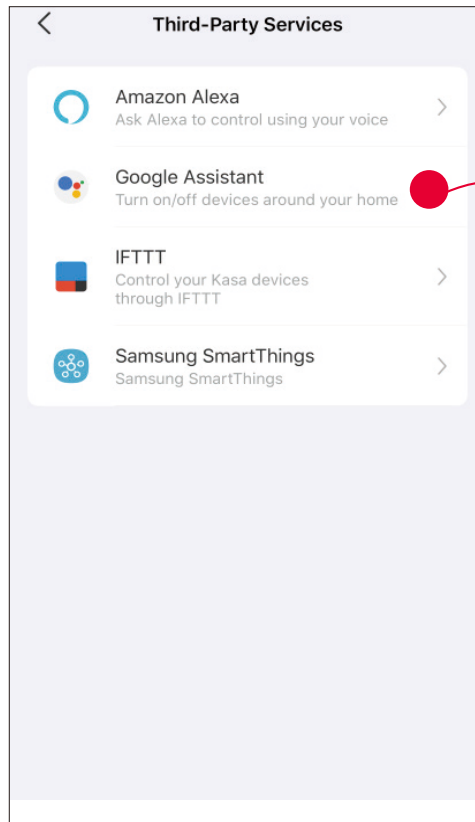

Authentication

CE Mark Warning



This is a class B product. In a domestic environment, this product may cause radio interference, in which case the user may be required to take adequate measures.

OPERATING FREQUENCY(the maximum transmitted power)

2400 MHz -2483.5 MHz(20dBm)

863.35/864.35/868.35MHz(25mW e.r.p)

EU declaration of conformity

TP-Link hereby declares that the device is in compliance with the essential requirements and other relevant provisions of directives 2014/53/EU, 2009/125/EC, 2011/65/EU and (EU)2015/863.

The original EU declaration of conformity may be found at <https://www.tp-link.com/en/ce>

RF Exposure Information

This device meets the EU requirements (2014/53/EU Article 3.1a) on the limitation of exposure of the general public to electromagnetic fields by way of health protection.

The device complies with RF specifications when the device used at 20 cm from your body.

UKCA Mark



UK declaration of conformity

TP-Link hereby declares that the device is in compliance with the essential requirements and other relevant provisions of the Radio Equipment Regulations 2017.

The original UK declaration of conformity may be found at <https://www.tp-link.com/support/ukca>



Продукт сертифіковано згідно с правилами системи УкрСЕПРО на відповідність вимогам нормативних документів та вимогам, що передбачені чинними законодавчими актами України.



Safety Information









- Do not attempt to disassemble, repair, or modify the device.
- Do not use the device where wireless devices are not allowed.
- Keep the device away from water, fire, humidity or hot environments.
- The socket-outlet shall be installed near the equipment and shall be easily accessible.

Please read and follow the above safety information when operating the device. We cannot guarantee that no accidents or damage will occur due to improper use of the device. Please use this product with care and operate at your own risk.

CAUTION!

Avoid replacement of a battery with an incorrect type that can defeat a safeguard. Avoid disposal of a battery into fire or a hot oven, or mechanically crushing or cutting of a battery, that can result in an explosion. Do not leave a battery in an extremely high temperature surrounding environment that can result in an explosion or the leakage of flammable liquid or gas; Do not leave a battery subjected to extremely low air pressure that may result in an explosion or the leakage of flammable liquid or gas.

Explanation of the symbols on the product label

| Symbol | Explanation |
|---|--|
|  | Indoor use only |
|  | AC voltage |
|  | DC voltage |
|  | <p>RECYCLING</p> <p>This product bears the selective sorting symbol for Waste electrical and electronic equipment (WEEE). This means that this product must be handled pursuant to European directive 2012/19/EU in order to be recycled or dismantled to minimize its impact on the environment.</p> <p>User has the choice to give his product to a competent recycling organization or to the retailer when he buys a new electrical or electronic equipment.</p> |
|  | Class II equipment |
|  | Caution, risk of electric shock |
|  | Fuse is used in neutral N |
|  | Caution |
|  | Operator's manual |