



# More Precision.

**confocalDT 2411** // Compact confocal measuring system







EtherCAT®

# Compact confocal measuring system for industrial series applications

## confocalDT 2411



Integrated fieldbus for direct connection to PLC

-  Most compact confocal controller
-  Excellent price/performance ratio
-  Robust aluminum housing (IP40)
-  Direct PLC connection due to Industrial Ethernet
-  For precise distance and thickness measurements



### Most compact design with highest performance and integrated Industrial Ethernet

The compact confocal IFD2411 measuring system is a factory-calibrated measuring system for industrial series applications. As well as displacement and distance measurements, the system enables even thickness measurements of transparent materials. The IFD2411 confocal chromatic measuring system is a complete channel which contains a controller and an adapted sensor with measuring ranges of 1 mm, 2 mm, 3 mm and 6 mm.

The confocal controller is now even smarter - thanks to the integrated Industrial Ethernet interface, you integrate the full sensor performance directly into your PLC. You benefit from real-time data without time delay and with reduced installation effort.

In Ethernet mode, the IFD2411 can be set via the intuitive web interface. Industrial Ethernet ensures that the settings are automatically applied to the PLC environment. This eliminates time-consuming setting efforts in the programming environment.

### Fast, precise and robust

An adjustable measuring rate of up to 8 kHz and submicrometer resolution down to 12 nm make the IFD2411 suitable for numerous measurement tasks. The active exposure regulation of the CCD line enables fast and reliable measurements on varying surfaces.

Thanks to its extremely compact design and its robust IP40 aluminum housing, the controller of the IFD2411 measuring system can be integrated in almost all existing plants and systems. Integrated DIN rail mounting enables fast installation in the control cabinet.

Due to its favorable price/performance ratio, this measuring system is ideal for series applications.



Simple parameter set up via integrated web interface

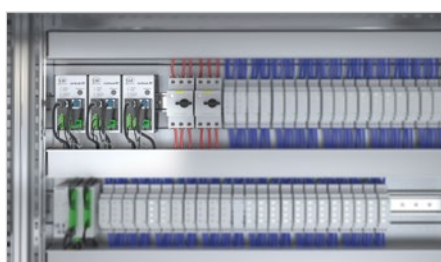

IFD2411 controller with compact design for easy integration into control cabinets.



Displacement and distance measurements in 3D printing machines

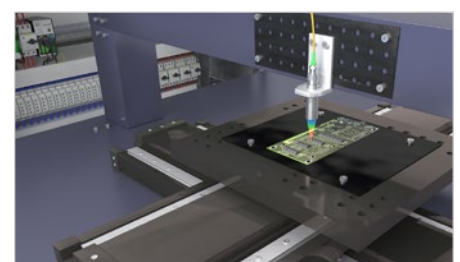

Measurement of electronic components in coordinate measuring machines

Model		IFD2411-1	IFD2411-2	IFD2411-3	IFD2411-6
Measuring range	Distance	1.0 mm	2.0 mm	3.0 mm	6.0 mm
Start of measuring range	approx.	15 mm	14 mm	25 mm	35 mm
Resolution	static <sup>1)</sup>	< 12 nm	< 40 nm	< 40 nm	< 80 nm
	dynamic <sup>2)</sup>	< 50 nm	< 125 nm	< 125 nm	< 250 nm
Measuring rate		continuously adjustable from 100 Hz to 8 kHz			
Linearity <sup>3)</sup>	Distance	< ±0.5 μm	< ±1.0 μm	< ±1.5 μm	< ±3.0 μm
	Thickness	< ±1.0 μm	< ±2.0 μm	< ±3.0 μm	< ±6.0 μm
Multi-layer measurement		1 layer			
Light source		internal white LED			
No. of characteristic curves		up to 10 characteristic curves for different sensors per channel, selection via table in the menu			
Permissible ambient light <sup>4)</sup>		30,000 lx			
Light spot diameter		12 μm	10 μm	18 μm	24 μm
Max. measuring angle <sup>5)</sup>		±25°	±12°	±20°	±10°
Numerical aperture (NA)		0.45	0.25	0.35	0.18
Min. target thickness <sup>6)</sup>		0.05 mm	0.1 mm	0.15 mm	0.3 mm
Target material		Glass, reflecting or diffuse surfaces			
Synchronization		yes			
Supply voltage		24 VDC ± 10 %			
Power consumption		approx. 5 W			
Signal input		sync-in / trig-in; 1x encoder (A+, A-, B+, B-, index)			
Digital interface		EtherCAT / RS422			
Analog output		Current: 4 ... 20 mA; voltage: 0 ... 5V & 0 ... 10 V (16 bit D/A converter)			
Digital output		sync-out			
Connector	Optical	pluggable optical fiber via E2000 socket, length 2 m ... 50 m, min. bending radius 30 mm			
	Electrical	3-pole supply terminal block; 5-pole I/O terminal block (max. cable length 30 m); 17-pin M12 plug for RS422, analog and encoder; RJ45 socket for Ethernet (out) / EtherCAT (in/out) (max. cable length 100 m)			
Mounting		free-standing, DIN rail mounting			
Temperature range	Storage	-20 ... +70 °C			
	Operation	+5 ... +50 °C			
Shock (DIN EN 60068-2-27)		15 g / 6 ms in XYZ axis, 1000 shocks each			
Vibration (DIN EN 60068-2-6)		2 g / 20 ... 500 Hz in XYZ axis, 10 cycles each			
Protection class (DIN EN 60529)		IP40			
Material		Aluminum			
Weight	Sensor	approx. 100 g	approx. 20 g	approx. 100 g	approx. 100 g
	Controller	approx. 335 g			
No. of measurement channels		1			
Control and indicator elements		Multifunction button: interfaces selection, two adjustable functions and reset to factory settings after 10 s; 4x color LEDs for Intensity, Range, RUN and ERR			

FSO = Full Scale Output

<sup>1)</sup> Average from 512 values at 1 kHz, in the mid of the measuring range onto optical flat

<sup>2)</sup> RMS noise relates to mid of measuring range (1 kHz)

<sup>3)</sup> All data at constant ambient temperature (25 ± 1 °C) against optical flat; specifications can change when measuring different objects.

<sup>4)</sup> Illuminant: light bulb

<sup>5)</sup> Maximum measuring angle of the sensor that produces a usable signal on reflecting surfaces. The accuracy decreases when approaching the limit values.

<sup>6)</sup> Glass sheet with refractive index n = 1.5 in midrange

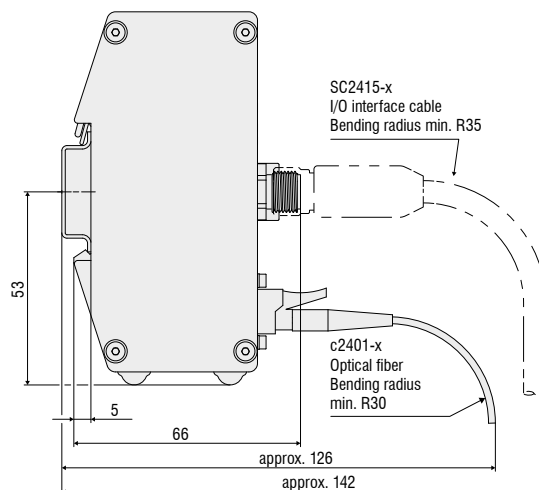
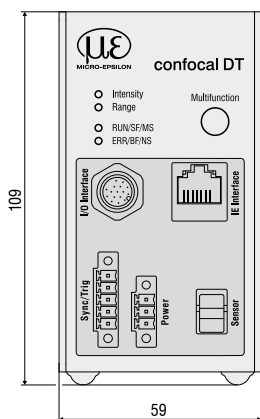

Dimensions in mm,  
not to scale.

SC2415-x/OE	
Minimum bending radius (mm)	static R35
	dynamic R70
	drag chain R83
Length	3 m/6 m/9 m/15 m

  

C2401-x	
Minimum bending radius (mm)	static R30
	dynamic R40
Length	2 m ... 50 m

Dimensional drawings of sensors

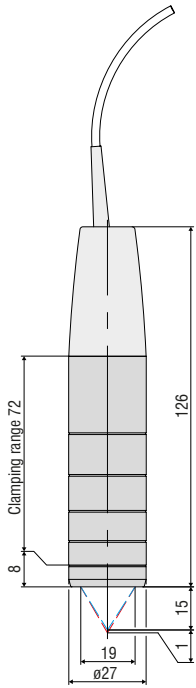

Sensor for IFD2411-1

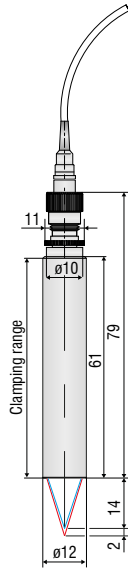

Sensor for IFD2411-2

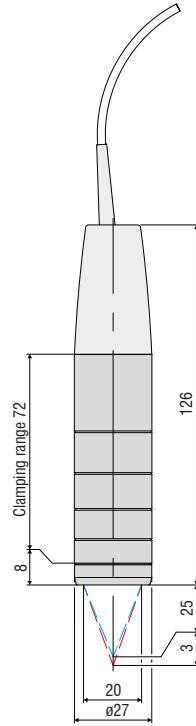

Sensor for IFD2411-3

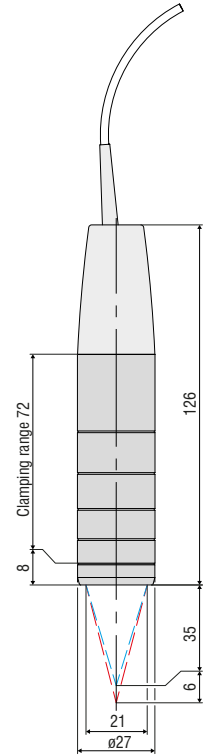

Sensor for IFD2411-6

Accessories: Sensor mounting adapter

MA2404-12 for IFD2411-2 sensor (consisting of mounting block and mounting ring)

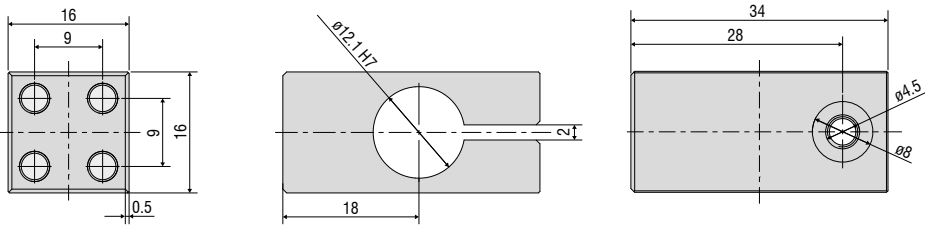

Accessories: Sensor mounting adapter

MA2400 for IFD2411-1, IFD2411-3 and IFD2411-6 sensors (consisting of mounting block and mounting ring)

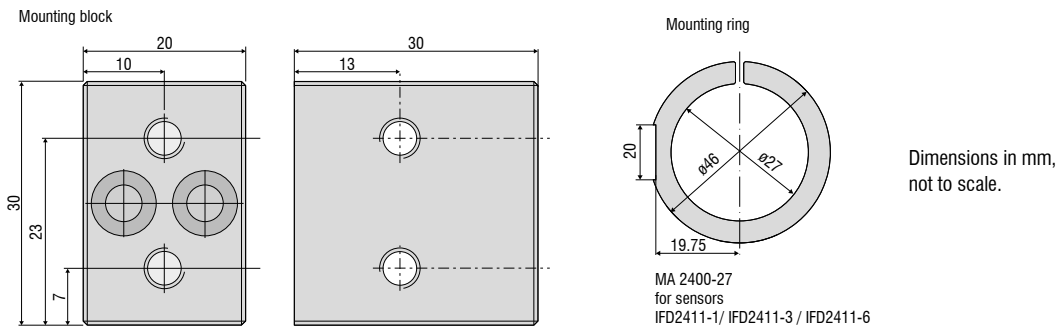

MICRO-EPSILON Headquarters  
Koenigbacher Str. 15 · 94496 Ortenburg / Germany  
Tel. +49 (0) 8542 / 168-0 · Fax +49 (0) 8542 / 168-90  
info@micro-epsilon.com · www.micro-epsilon.com