

46 Series

Mechanical Stroke Counter

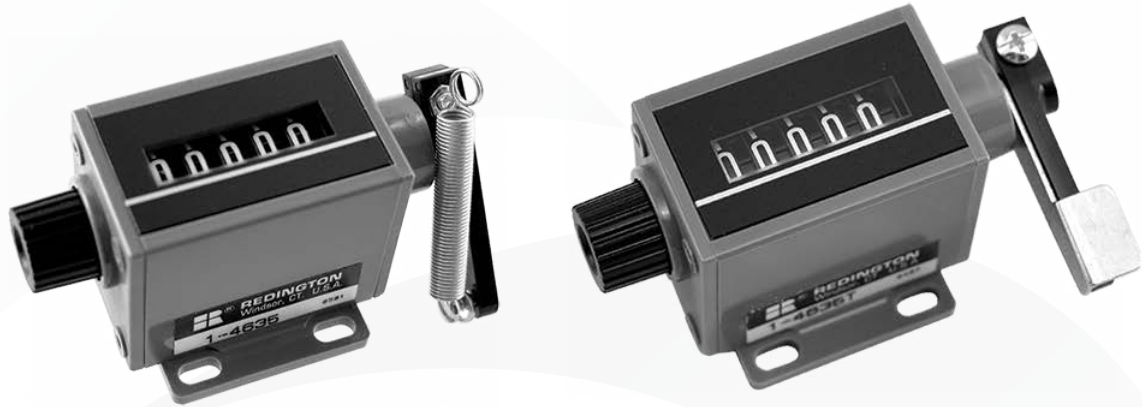

These 5 figure stroke counters are especially designed for limited space and high count life applications. The advanced drive system translates into exceptionally high operating speeds, extended operating life, for fast and accurate readings. Ideal for copiers, printing presses, cut-off machines, and piece-part counting applications. Also available with a thumb lever for use as a tally counter

Key Features

- Compact size
- Reliability
- Low cost
- Optional special levers
 - Special Metal Lever
 - Lever and spring
- Optional non-reset – consult factory

Applications

- Copiers
- Printing press
- Farm equipment
- Piece-part counting
- Shearing/cut-off machines

Specification

Figures	5 figures, white on black, 0.19" [5mm] high
Reset	Standard knob
Speed	1,000 counts/minute
Rotation	Top-coming or top-going
Count Stroke	40° Min. - 45° Max.
Shaft Extension	Right-hand or left-hand
Shaft Diameter	0.156" [4.0mm]
Operating Life	Beyond 5 million counts
Temp. Range	-15°F to +140°F [-25°C to +60°C]
Weight	2 oz. [57g]

Dimensions

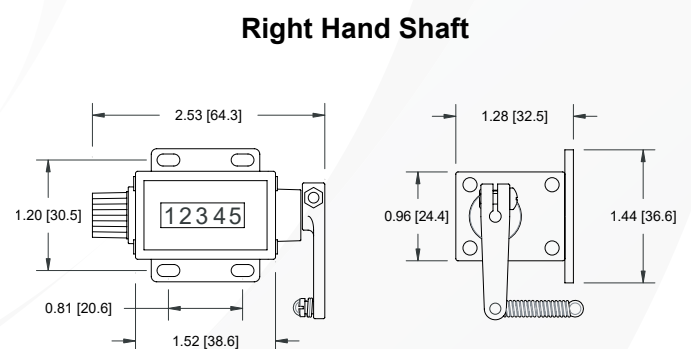

Mounting holes: 0.13" x 0.24" [3.3 x 6.1mm] slots

Mechanical Rotation

Totalizing counters are used to sum the total number of cycles or inputs to a device. These counters have no “outputs”. Totalizers can be Mechanical, Electromechanical or Electronic.

Totalizers are typically used to total cycle count, piece count, and linear length or to indicate position. Displays for Mechanical & Electromechanical Totalizers are molded figure wheels usually displaying 0-9 digits on a contrasting background and have a count capacity of 3-8 figures.

Mechanical Totalizers

The input for Mechanical Totalizers can be Rotary, Stroke or Rotary Ratchet. Mechanical Totalizers require no operating power or sensor and are easy to install. For hand operated applications you need to consider our Model 46 with thumb lever option.

Basic operation of a mechanical stroke counter

The illustration (right) shows the lever in the rest position with a total shaft rotation of $X+Y+Z$. Although these angles may differ from model to model, the total shaft rotation contains a pre-travel (X), a count stroke (Y), and an over-travel (Z). The lever must start in the pre-travel area and continue through to the over-travel area to register a count. It is recommended that the spring furnished with the counter be used to simplify adjustment of count stroke to drive mechanism.

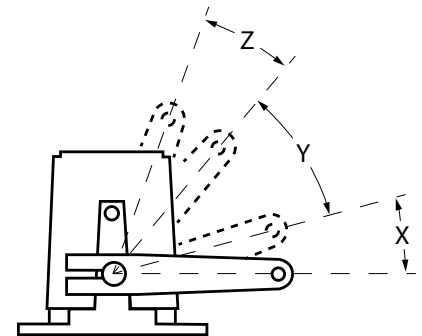

Note: This illustrates rotations 2 and 3 only.

SHAFT ROTATIONS:

Arrows indicate shaft rotation to increase count:

Left-hand top-coming:
(rotation #1)

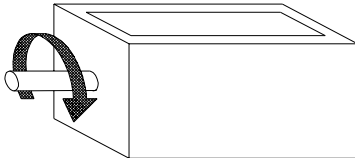

Left-hand top-going:
(rotation #2)

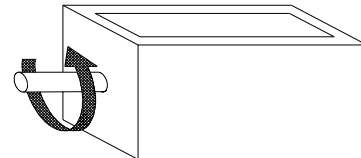

Right-hand top-coming:
(rotation #3)

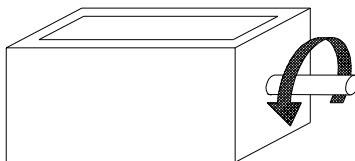

Right-hand top-going:
(rotation #4)

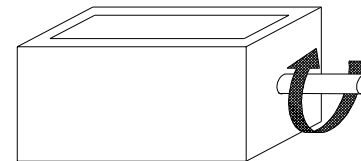

Part Numbers:

1-4615 Left-hand, top-coming, standard reset knob
1-4625 Left-hand, top-going, standard reset knob
1-4635 Right-hand, top-coming, standard reset knob
1-4645 Right-hand, top-going, standard reset knob

1-4635T
10007-001
10007-009S

Right-hand, top-coming, std. reset knob,
with thumb lever
Special Metal Lever
Spring and Lever Kit