



Step-Down, 1A LED Driver

Features

- 1A constant output current
- 96% efficiency @ input voltage 12V, 350mA, 3-LED
- 9~36V input voltage range
- Hysteretic PFM improves efficiency at light loading
- Settable output current
- Integrated power switch with 0.45ohm low Rds(on)
- Full protection: Thermal/UVLO/Start-Up/LED Open-/Short- Circuit
- Only 4 external components required

Product Description

The MBI6651 is a high efficiency, constant current and step-down DC/DC converter. It is designed to deliver constant current to light up high power LED with only 4 external components. With hysteretic PFM control scheme, MBI6651 improves the efficiency of light loading. The output current of MBI6651 can be programmed by an external resistor and LED dimming can be controlled via pulse width modulation (PWM) through DIM pin. In addition, the start-up function limits the inrush current while the power is switch on. The MBI6651 also features under voltage lock out (UVLO), over temperature protection, LED open-circuit protection and LED short-circuit protection to protect IC from being damaged.

Additionally, to ensure the system reliability, the MBI6651 builds thermal protection (TP) function inside. This function protects IC from overheating (165°C) in various application conditions. MBI6651 provides thermal-enhanced packages as well to handle power dissipation more efficiently. MBI6651 is available in TO-252, SOT-23 and MSOP-8 packages.

Surface Mount Device

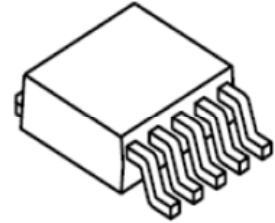

GSD : TO-252-5L

Small Outline Transistor

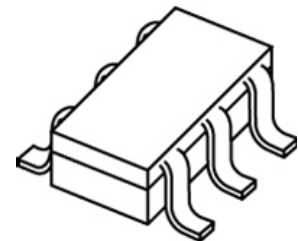

GST: SOT-23-6L

Mini Small Outline Package



GMS: MSOP-8L-118mil

Applications

- Signage and Decorative LED Lighting
- Automotive LED Lighting
- High Power LED Lighting
- Constant Current Source

MBI6651

Step-Down, 1A LED Driver

Typical Application Circuit

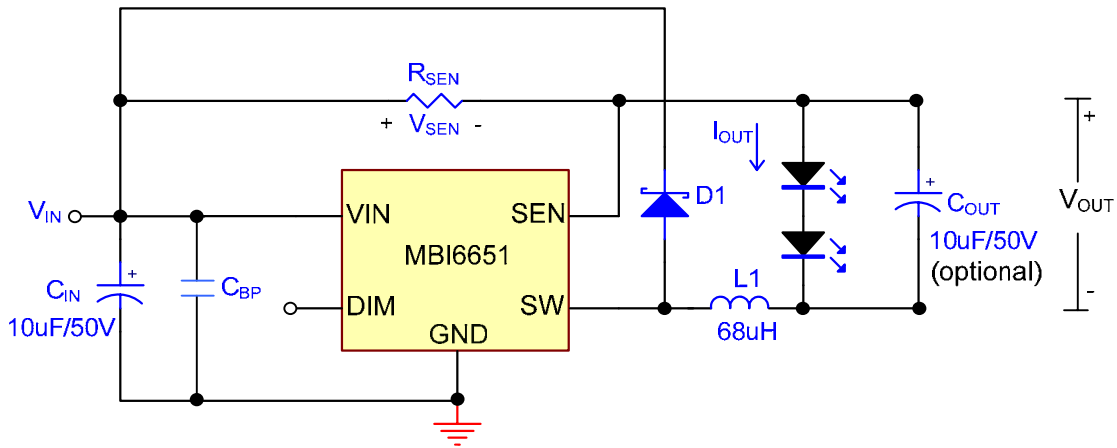

- C_{IN}: VISHAY, 293D106X9050D2TE3, D case Tantalum Capacitor
- C_{OUT}: VISHAY, 293D106X9050D2TE3, D case Tantalum Capacitor
- C_{BP}: TAIYO YUDEN, UMK212B7104MG-T, 0805 Ceramic Capacitor
- L1: GANG SONG, GSDS106C2-680M
- D1: ZOWIE, SSCD206
- R_{SEN}: VIKING, CSO6FTEUR100, 1206

Fig. 1

Functional Diagram

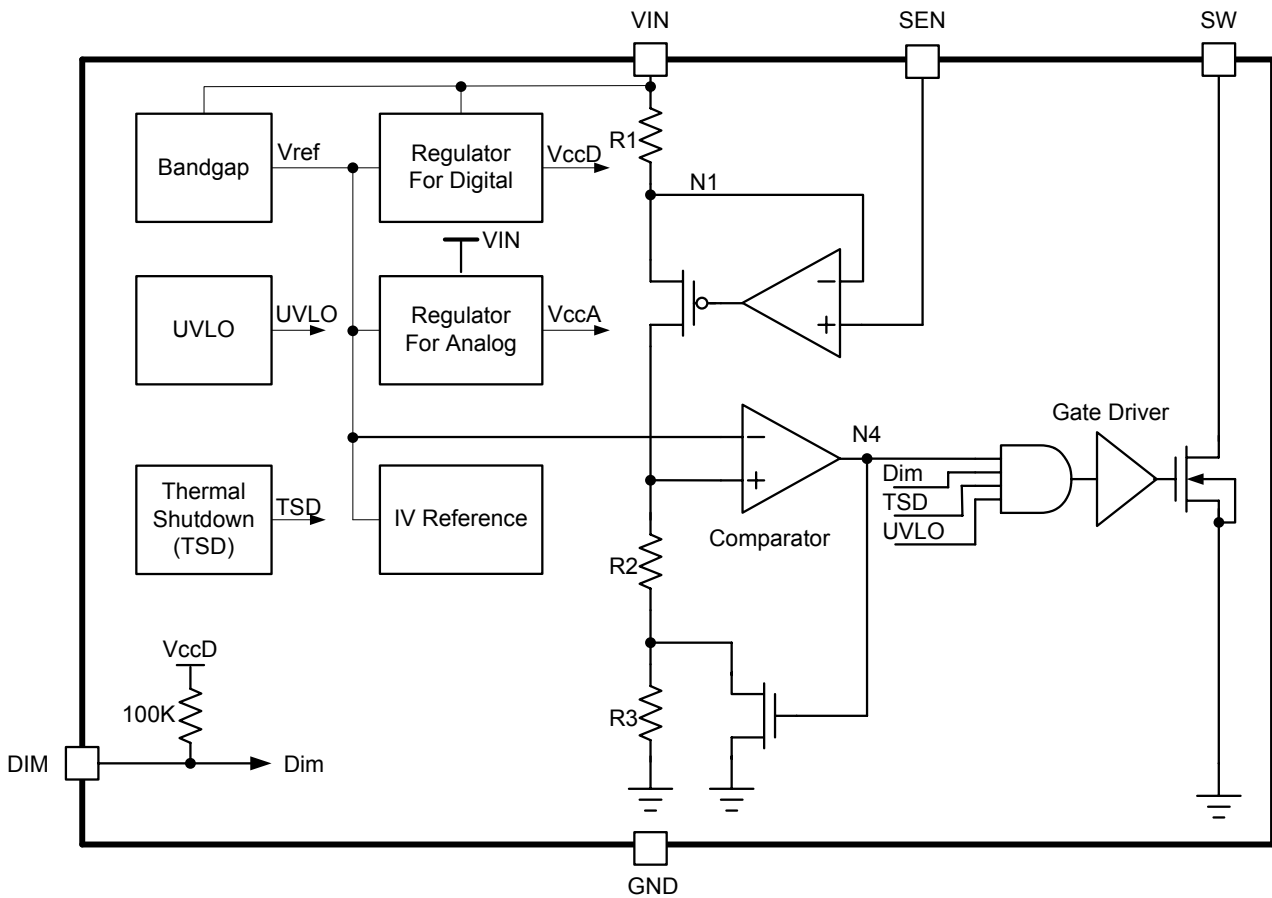
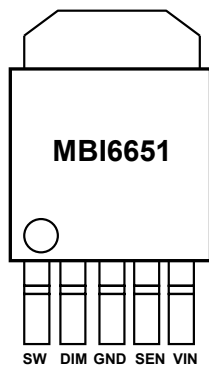

Fig. 2

MBI6651**Step-Down, 1A LED Driver**

Pin Configuration



GSD: TO-252

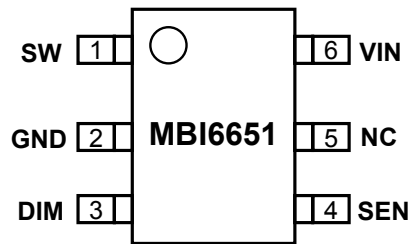

GST: SOT-23

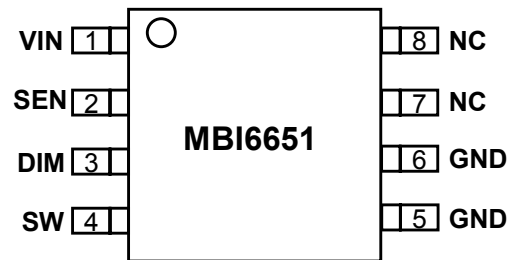

GMS: MSOP-8L

Pin Description

Pin Name	Function
GND	Ground terminal for control logic and current sink
SW	Switch output terminal
DIM	Dimming control terminal
SEN	Output current sense terminal
VIN	Supply voltage terminal
NC	No Connection
Thermal Pad	Power dissipation terminal connected to GND*

*To eliminate noise influence, the thermal pad is suggested to connect to GND on PCB. In addition, when a heat-conducting copper foil on PCB is soldered with thermal pad, the desired thermal conductivity will be improved.

MBI6651**Step-Down, 1A LED Driver****Maximum Ratings**

Operation above the maximum ratings may cause device failure. Operation at the extended periods of the maximum ratings may reduce the device reliability.

Characteristic		Symbol	Rating	Unit
Supply Voltage		V_{IN}	0~40	V
Output Current		I_{OUT}	1.2	A
Sustaining Voltage at DIM pin		V_{DIM}	40	V
Sustaining Voltage at SW pin		V_{SW}	-0.5~45	V
GND Terminal Current		I_{GND}	1.2	A
Power Dissipation (On 4 Layer PCB, $T_a=25^{\circ}C$)*	GSD Type	P_D	3.80	W
Thermal Resistance (By simulation, on 4 Layer PCB)*		$R_{th(j-a)}$	32.9	$^{\circ}C/W$
Power Dissipation (On 4 Layer PCB, $T_a=25^{\circ}C$)*	GST Type	P_D	0.51	W
Thermal Resistance (By simulation, on 4 Layer PCB)*		$R_{th(j-a)}$	244	$^{\circ}C/W$
Power Dissipation (On 4 Layer PCB, $T_a=25^{\circ}C$)*	GMS Type	P_D	3.33	W
Thermal Resistance (By simulation, on 4 Layer PCB)*		$R_{th(j-a)}$	37.53	$^{\circ}C/W$
Junction Temperature		$T_{j,max}$	150**	$^{\circ}C$
Operating Temperature		T_{opr}	-40~+125	$^{\circ}C$
Storage Temperature		T_{stg}	-55~+150	$^{\circ}C$

*The PCB size is 76.2mm*114.3mm in simulation. Please refer to JEDEC JESD51.

** Operation at the maximum rating for extended periods may reduce the device reliability; therefore, the suggested operation temperature of the device (T_{opr}) is under 125 $^{\circ}C$.

Note: The performance of thermal dissipation is strongly related to the size of thermal pad, thickness and layer numbers of the PCB. The empirical thermal resistance may be different from simulative value. Users should plan for expected thermal dissipation performance by selecting package and arranging layout of the PCB to maximize the capability.

MBI6651**Step-Down, 1A LED Driver****Electrical Characteristics**

Test condition: $V_{IN}=12V$, $V_{OUT}=3.6V$, $L1=68\mu H$, $C_{IN}=C_{OUT}=10\mu F$, $T_A=25^\circ C$; unless otherwise specified. Please refer to test circuit (a) of Fig. 3.)

Characteristics		Symbol	Condition	Min.	Typ.	Max.	Unit
Supply Voltage		V_{IN}	-	9	-	36	V
Supply Current		I_{IN}	$V_{IN}=9V\sim 36V$	-	1	2	mA
Output Current		I_{OUT}	-	-	350	1000	mA
Output Current Accuracy		dI_{OUT}/I_{OUT}	$350mA \leq I_{OUT} \leq 1000mA$,	-	± 3	± 5	%
SW Dropout Voltage		V_{SW}	$I_{OUT}=1A$	-	0.45	-	V
Internal Propagation Delay Time		T_{pd}		100	196	300	ns
Efficiency		-	$V_{IN}=12V$, $I_{OUT}=350mA$, $V_{OUT}=10.8V$	-	96	-	%
Input Voltage	"H" level	V_{IH}	-	3.5	-	-	V
	"L" level	V_{IL}	-	-	-	0.5	V
Switch ON Resistance		$R_{ds(on)}$	$V_{IN}=12V$; refer to test circuit (b)	0.4	0.45	0.6	Ω
Minimum Switch ON Time*		$T_{ON,min}$		100	350	450	ns
Minimum Switch OFF Time*		$T_{OFF,min}$		100	350	450	ns
Recommended Duty Cycle Range of SW*		D_{sw}		20	-	80	%
Maximum Operating frequency		$Freq_{Max}$		40	-	1000	kHz
CURRENT SENSE							
Mean SEN Voltage		V_{SEN}	$V_{IN}=10V$, $V1=1V$, refer to test circuit (c)	95	100	105	mV
THERMAL OVERLOAD							
Thermal Shutdown Threshold*		T_{SD}	-	145	165	175	$^\circ C$
Thermal Shutdown Hysteresis*		T_{SD-HYS}	-	20	30	40	$^\circ C$
UNDER VOLTAGE LOCK OUT							
UVLO Voltage		-	$T_A=-40\sim 85^\circ C$	7.7	8	8.3	V
UVLO Hysteresis		-	-	0.15	0.2	0.35	V
Start Up Voltage		-	-	7.85	8.2	8.65	V
DIMMING							
Duty Cycle Range of PWM Signal Applied to DIM pin		$Duty_{DIM}$	PWM frequency: 100Hz ~ 1kHz	1	-	100	%

*Guaranteed by Design.

MBI6651

Step-Down, 1A LED Driver

Test Circuit for Electrical Characteristics

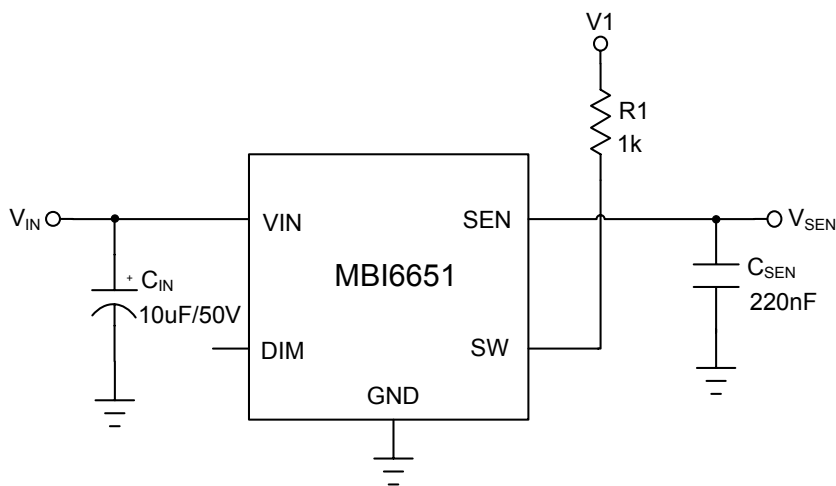
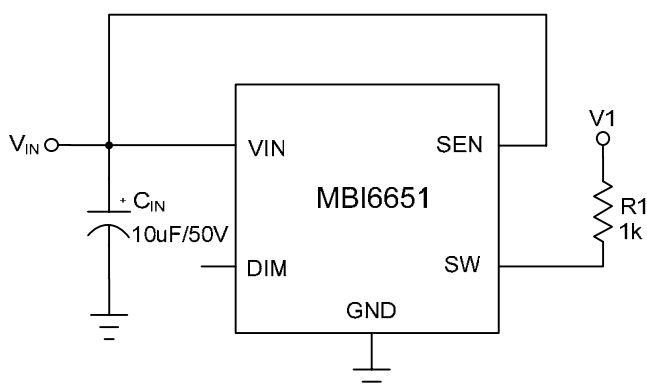
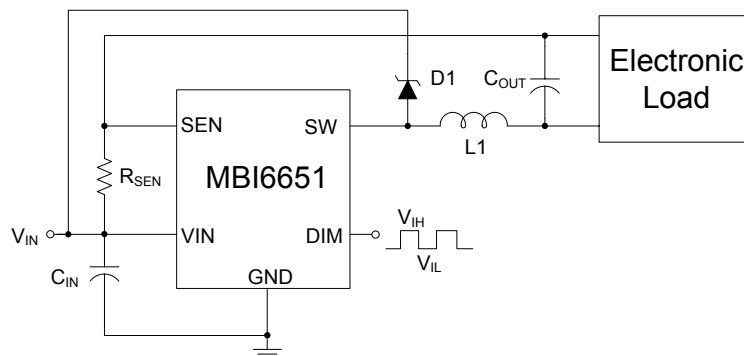

Fig. 3

MBI6651

Step-Down, 1A LED Driver

Typical Performance Characteristics

Please refer to Typical Application Circuit, $V_{IN}=12V$, $L1=68\mu H$, $C_{IN}=C_{OUT}=10\mu F$, $T_A=25^\circ C$, unless otherwise specified.

1-LED $V_F=3.6V$; 2-LED $V_F=7.2V$; 3-LED $V_F=10.8V$; 4-LED $V_F=14.4V$; 5-LED $V_F=18V$

1. Efficiency vs. Input Voltage at Various LED Cascaded Numbers

Efficiency vs. input voltage @ $L1=22\mu H$

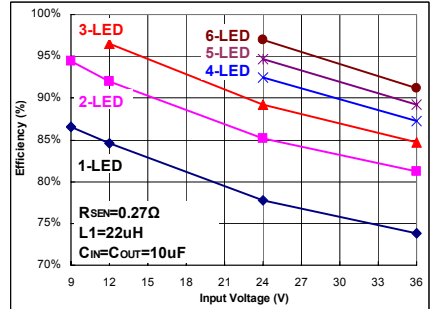
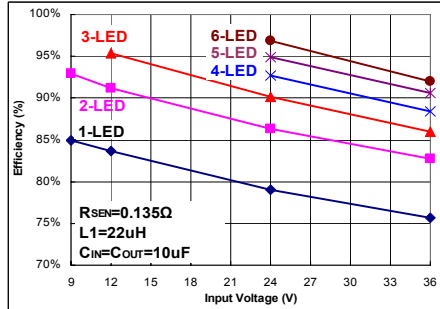
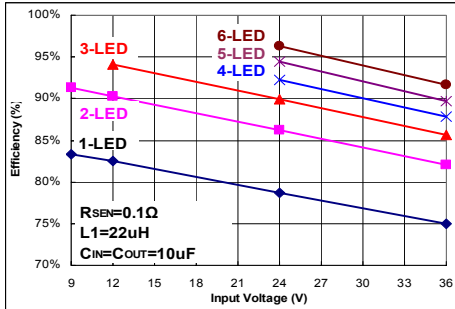

Fig 4. $I_{OUT}=1A$

Fig 5. $I_{OUT}=740mA$

Fig 6. $I_{OUT}=370mA$

Efficiency vs. input voltage @ $L1=68\mu H$

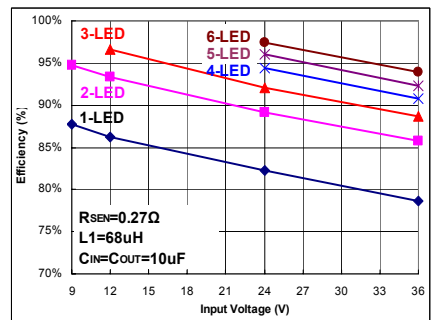
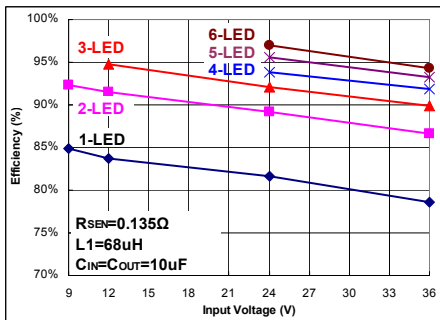
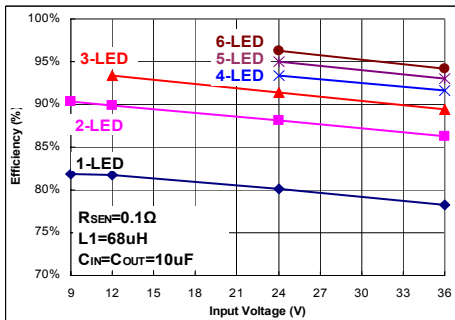

Fig 7. $I_{OUT}=1A$

Fig 8. $I_{OUT}=740mA$

Fig 9. $I_{OUT}=370mA$

Efficiency vs. input voltage @ $L1=100\mu H$

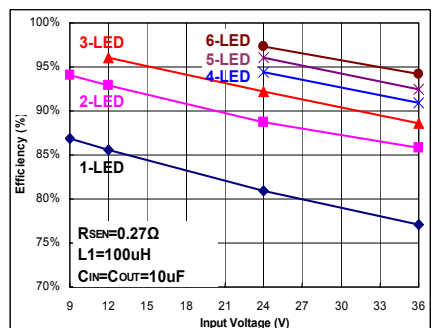
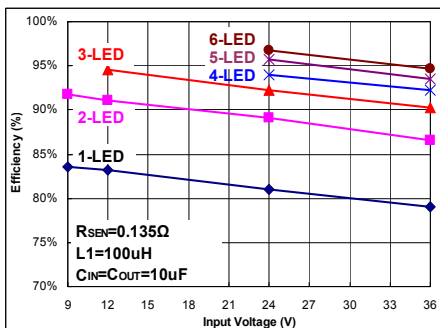
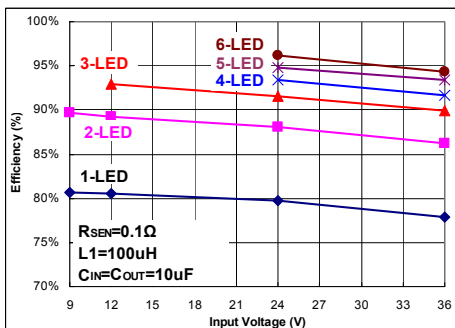

Fig 10. $I_{OUT}=1A$

Fig 11. $I_{OUT}=740mA$

Fig 12. $I_{OUT}=370mA$

MBI6651

Step-Down, 1A LED Driver

2. Efficiency vs. LED Cascaded Number at Various Input Voltage

Efficiency vs. LED cascaded number @ L1=22uH

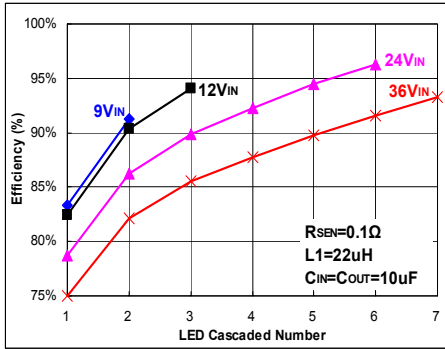

Fig 13. $I_{OUT}=1A$

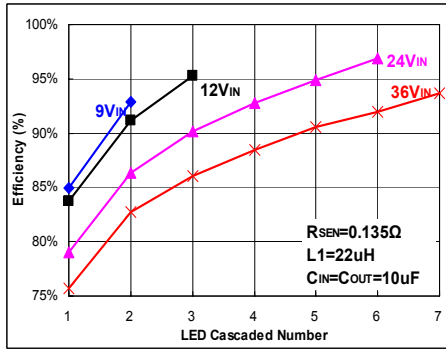

Fig 14. $I_{OUT}=740mA$

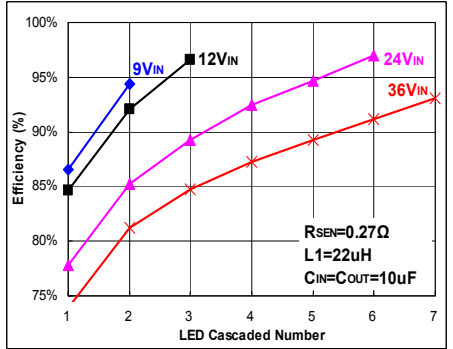

Fig 15. $I_{OUT}=370mA$

Efficiency vs. LED cascaded number @ L1=68uH

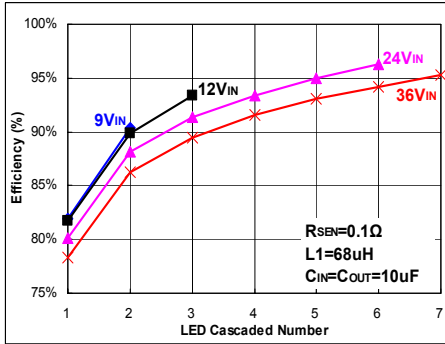

Fig 16. $I_{OUT}=1A$

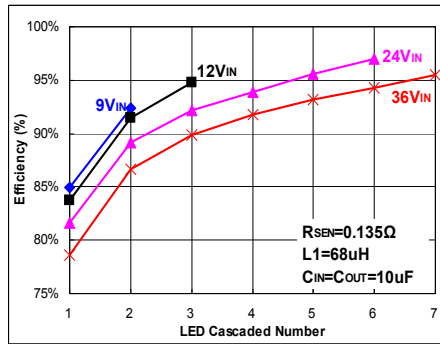

Fig 17. $I_{OUT}=740mA$

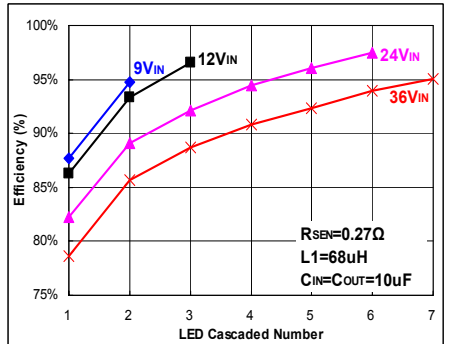

Fig 18. $I_{OUT}=370mA$

Efficiency vs. LED cascaded number @ L1=100uH

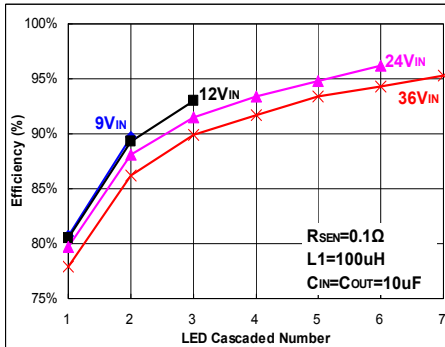

Fig 19. $I_{OUT}=1A$

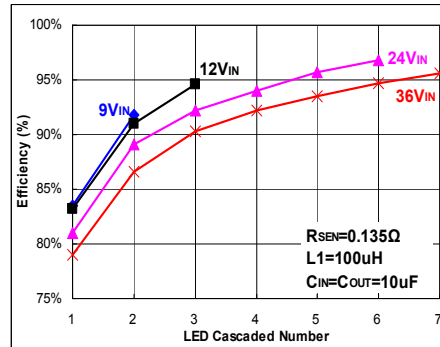

Fig 20. $I_{OUT}=740mA$

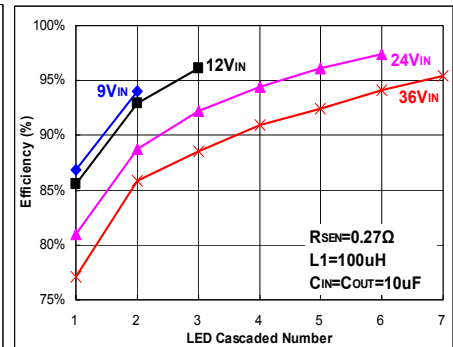

Fig 21. $I_{OUT}=370mA$

MBI6651

Step-Down, 1A LED Driver

3. Output Current vs. Input Voltage at Various LED Cascaded Numbers

Output current vs. input voltage @ L1=22uH

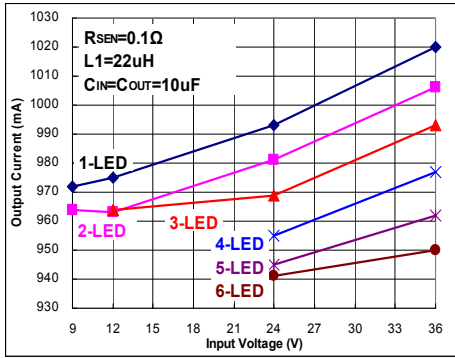

Fig 22. I_{OUT}=1A

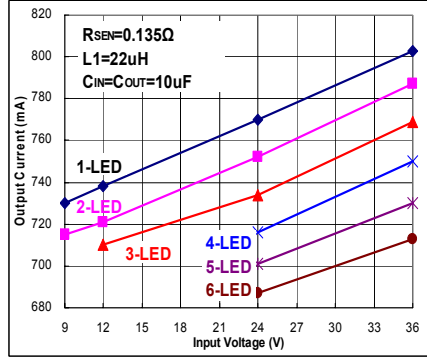

Fig 23. I_{OUT}=740mA

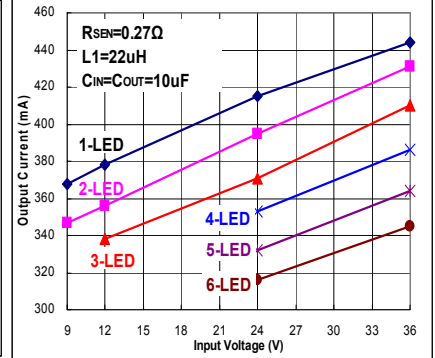

Fig 24. I_{OUT}=370mA

Output current vs. input voltage @ L1=68uH

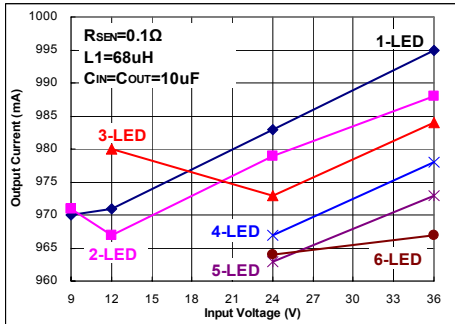

Fig 25. I_{OUT}=1A

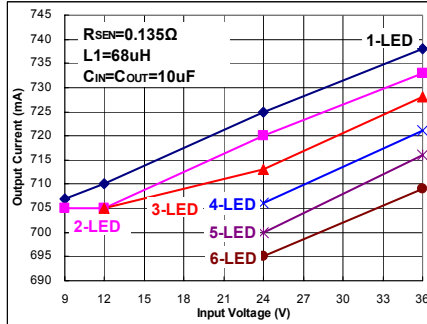

Fig 26. I_{OUT}=740mA

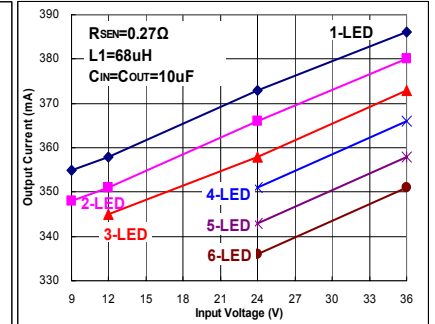

Fig 27. I_{OUT}=370mA

Output current vs. input voltage @ L1=100uH

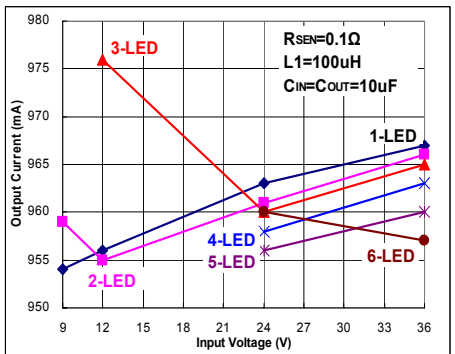

Fig 28. I_{OUT}=1A

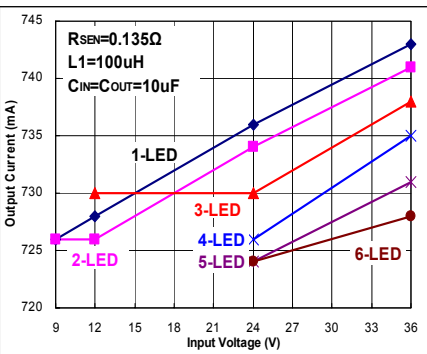

Fig 29. I_{OUT}=740mA

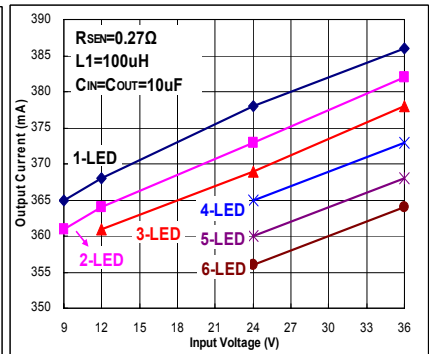

Fig 30. I_{OUT}=370mA

4. Output Current vs. Input Voltage at Various Inductors

Output current vs. input voltage @ 1-LED in cascaded

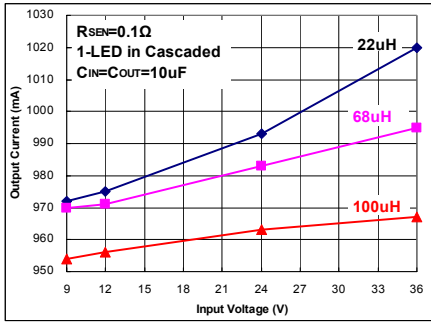

Fig 31. I_{OUT}=1A

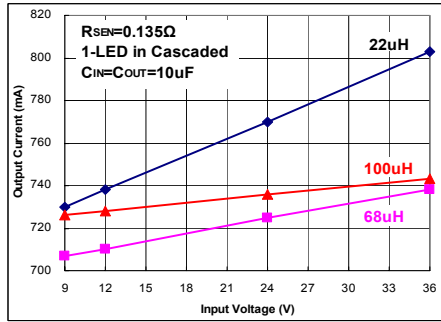

Fig 32. I_{OUT}=740mA

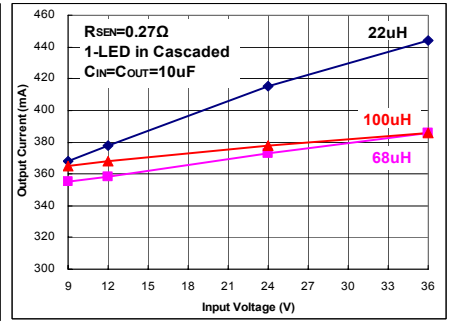

Fig 33. I_{OUT}=370mA

Output current vs. input voltage @ 2-LED in cascaded

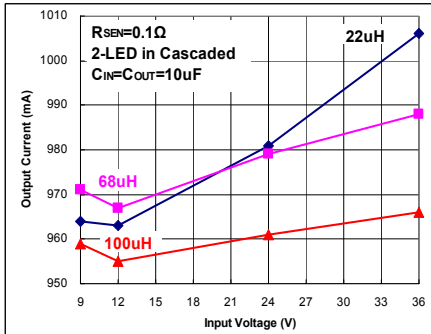

Fig 34. I_{OUT}=1A

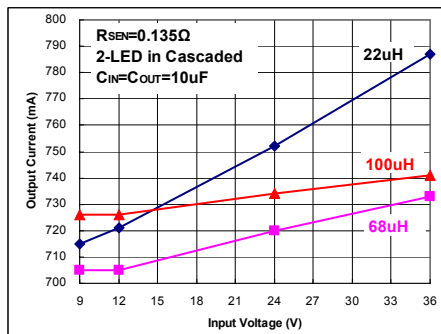

Fig 35. I_{OUT}=740mA

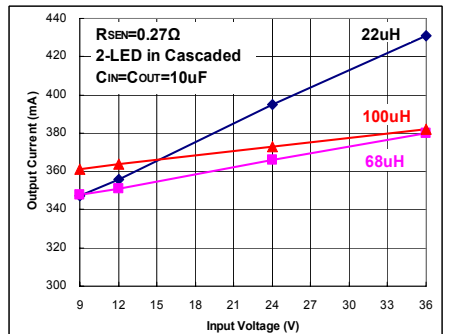

Fig 36. I_{OUT}=370mA

Output current vs. input voltage @ 3-LED in cascaded

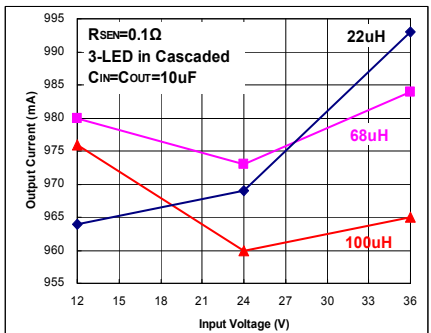

Fig 37. I_{OUT}=1A

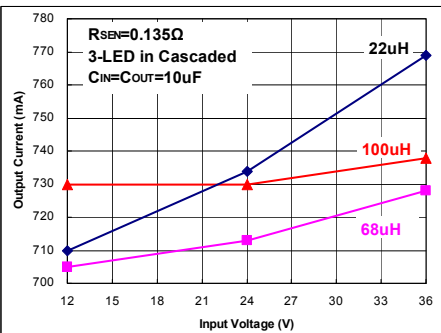

Fig 38. I_{OUT}=740mA

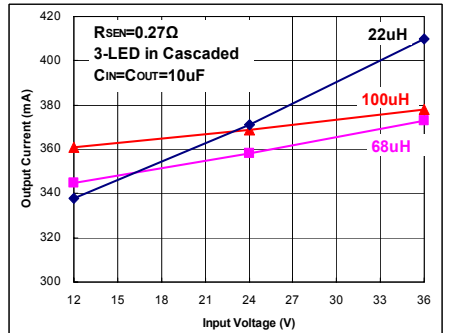

Fig 39. I_{OUT}=370mA

MBI6651

Step-Down, 1A LED Driver

5. Output Current vs. LED Cascaded Number at Various Input Voltage

Output current vs. LED cascaded number @ L1=22uH

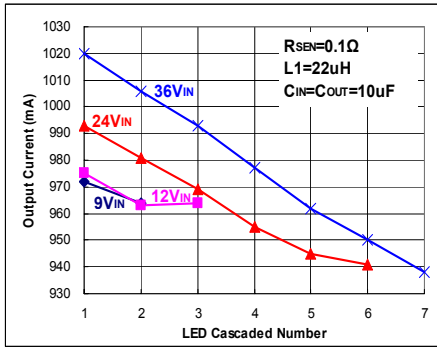

Fig 40. I_{OUT}=1A

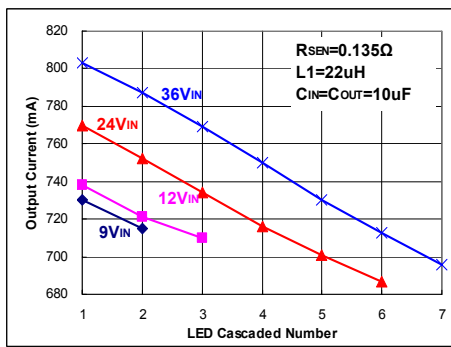

Fig 41. I_{OUT}=740mA

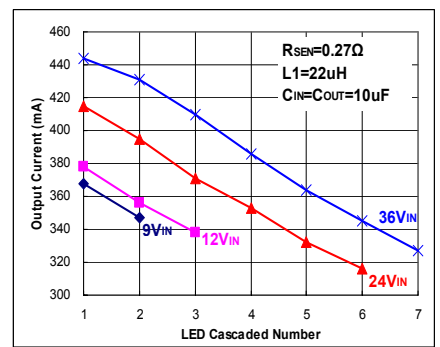

Fig 42. I_{OUT}=370mA

Output current vs. LED cascaded number @ L1=68uH

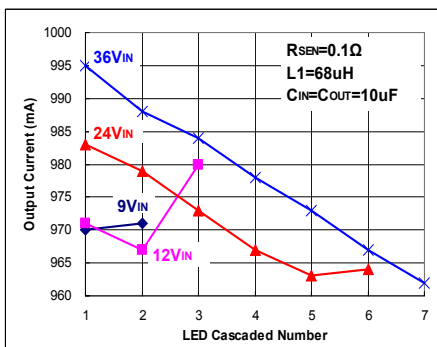

Fig 43. I_{OUT}=1A

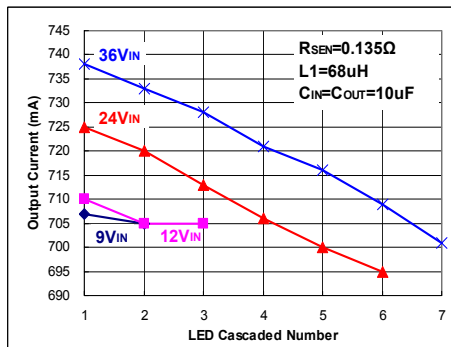

Fig 44. I_{OUT}=740mA

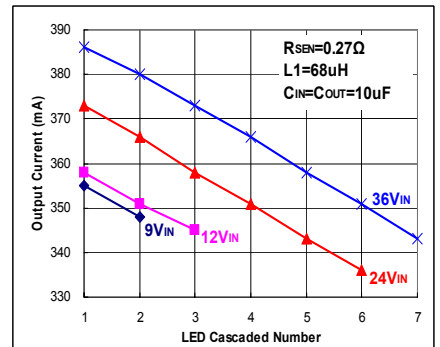

Fig 45. I_{OUT}=370mA

Output current vs. LED cascaded number @ L1=100uH

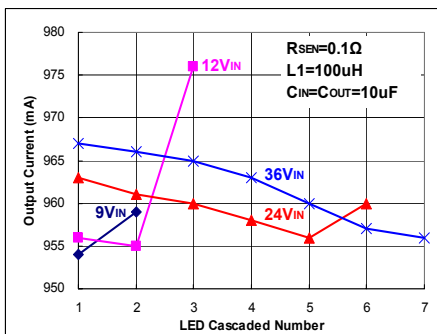

Fig 46. I_{OUT}=1A

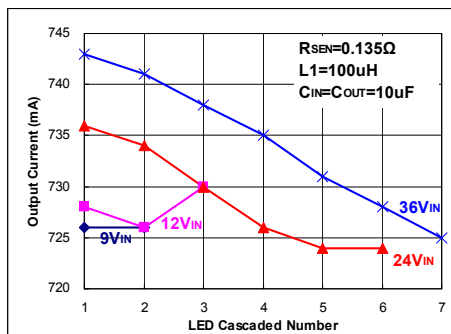

Fig 47. I_{OUT}=740mA

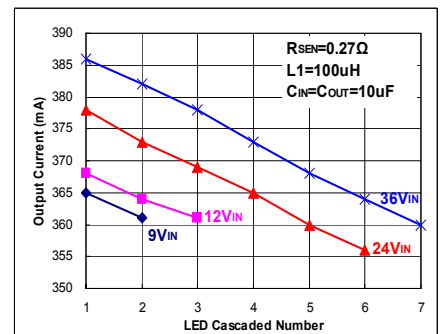

Fig 48. I_{OUT}=370mA

MBI6651

Step-Down, 1A LED Driver

6. Output Current vs. LED Cascaded Number at Various Inductor

Output current vs. LED cascaded number @ $V_{IN}=12V$

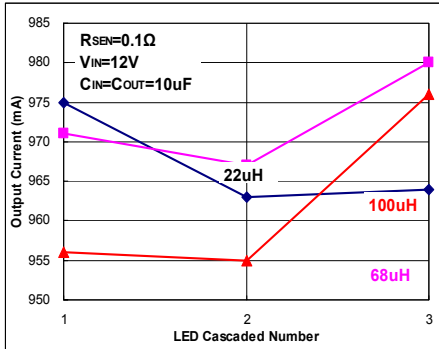

Fig 49. $I_{OUT}=1A$

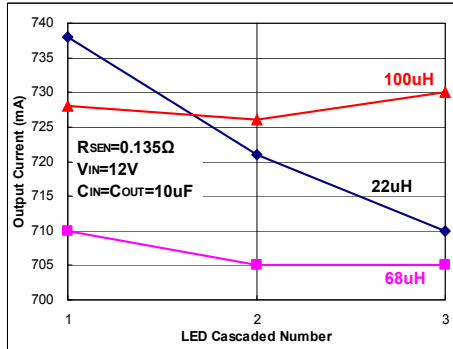

Fig 50. $I_{OUT}=740mA$

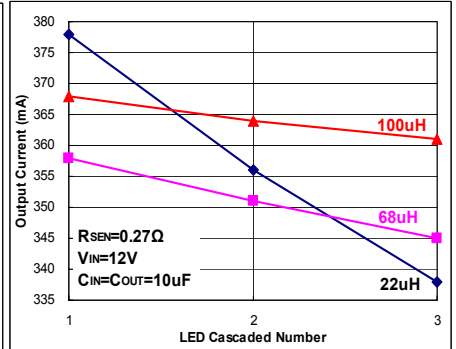

Fig 51. $I_{OUT}=370mA$

Output current vs. LED cascaded number @ $V_{IN}=24V$

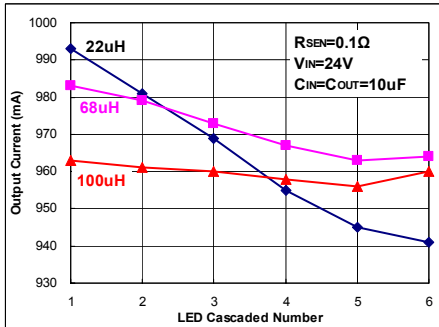

Fig 52. $I_{OUT}=1A$

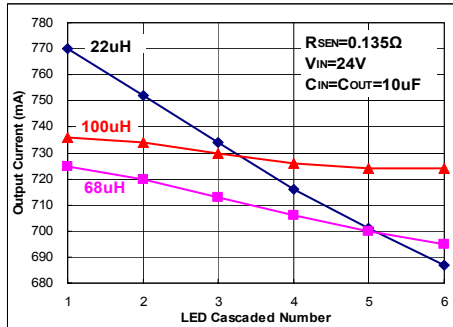

Fig 53. $I_{OUT}=740mA$

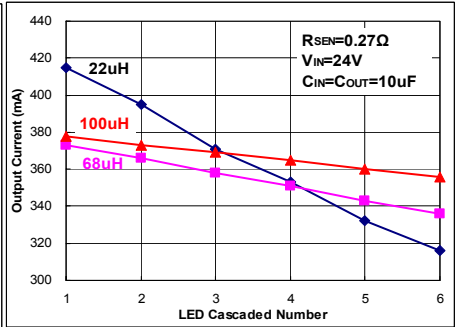

Fig 54. $I_{OUT}=370mA$

Output current vs. LED cascaded number @ $V_{IN}=36V$

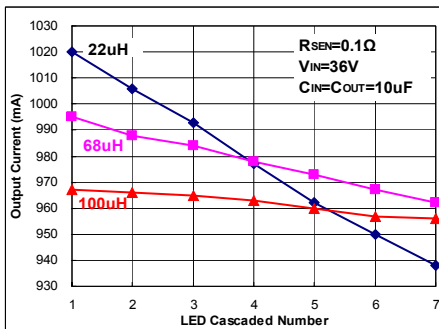

Fig 55. $I_{OUT}=1A$

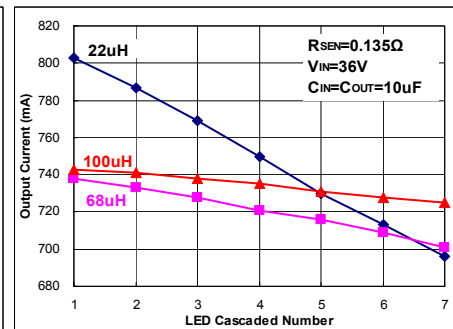

Fig 56. $I_{OUT}=740mA$

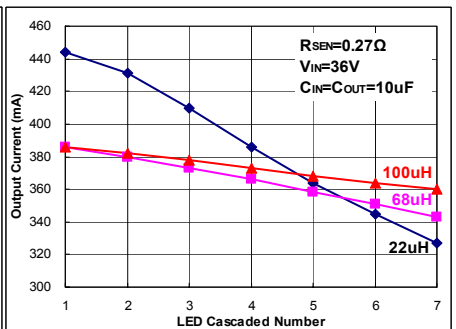

Fig 57. $I_{OUT}=370mA$

MBI6651

Step-Down, 1A LED Driver

7. Switching Frequency vs. LED Cascaded Number at Various Inductor

Switching frequency vs. LED cascaded number @ $V_{IN}=12V$

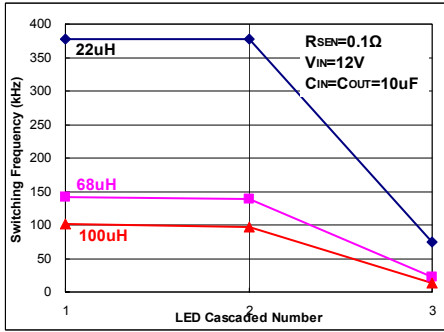

Fig 58. $I_{OUT}=1A$

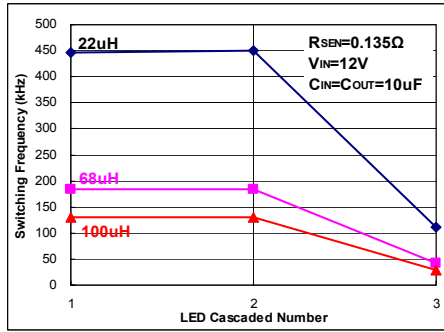

Fig 59. $I_{OUT}=740mA$

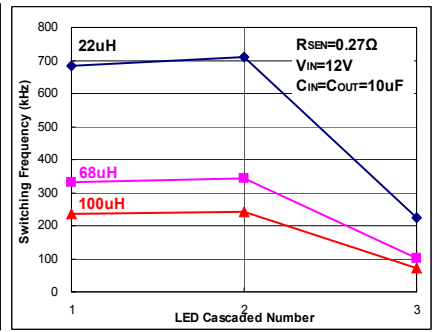

Fig 60. $I_{OUT}=370mA$

Switching frequency vs. LED cascaded number @ $V_{IN}=24V$

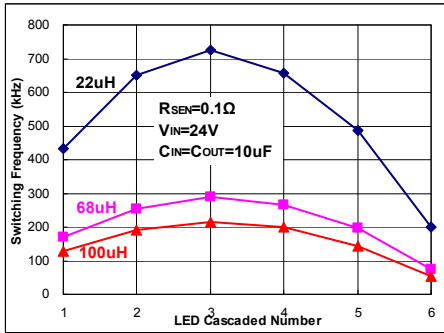

Fig 61. $I_{OUT}=1A$

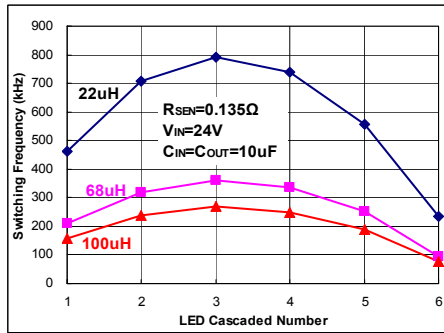

Fig 62. $I_{OUT}=740mA$

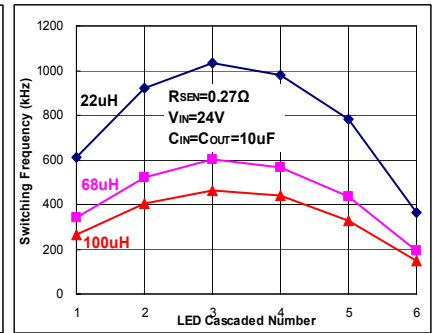

Fig 63. $I_{OUT}=370mA$

Switching frequency vs. LED cascaded number @ $V_{IN}=36V$

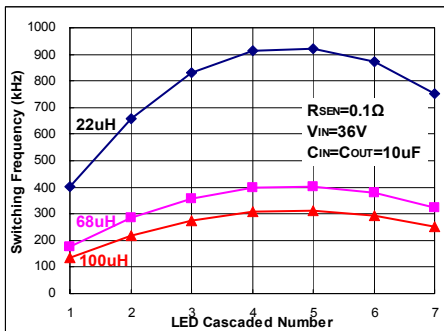

Fig 64. $I_{OUT}=1A$

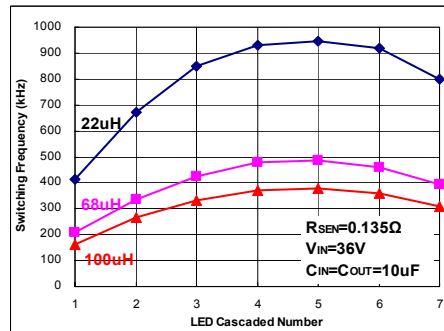

Fig 65. $I_{OUT}=740mA$

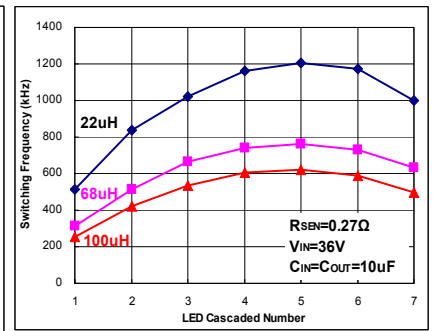

Fig 66. $I_{OUT}=370mA$

MBI6651

Step-Down, 1A LED Driver

8. Miscellaneous

(a) Dimming and switching waveforms

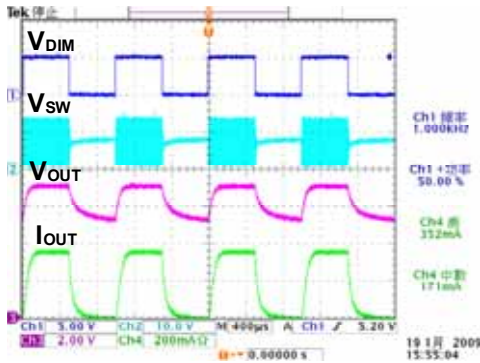

Fig 67. Dimming waveform
($V_{IN}=12V$, $R_{SEN}=0.27$, 2-LED)

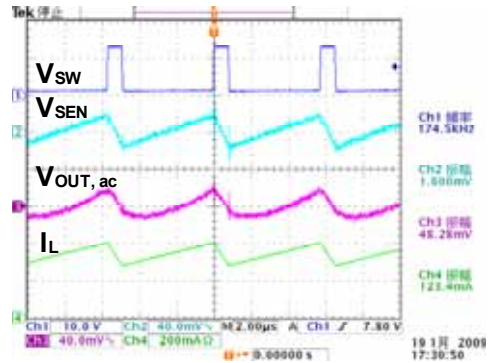

Fig 68. Switching waveform
($12V_{IN}$, $3.6V_{OUT}$, $R_{SEN}=0.27$)

(b) Line transient response

Line transient response @ $V_{IN}=13V \leftrightarrow 24V$, $V_{OUT}=10V$, $R_{SEN}=0.27$

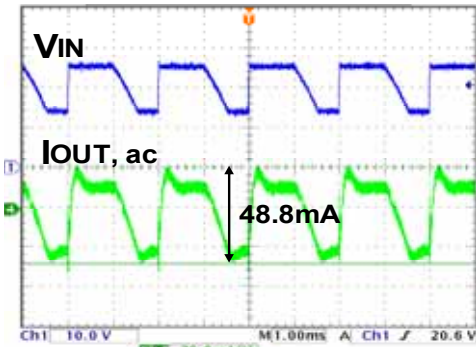

Fig 69. L1=22uH

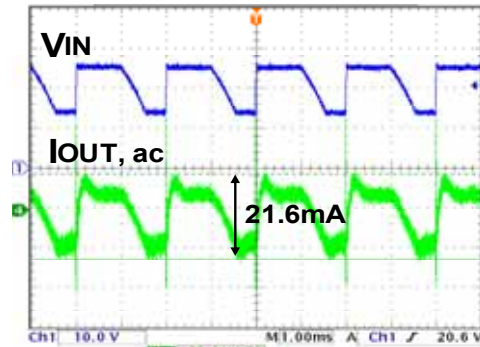

Fig 70. L1=68uH

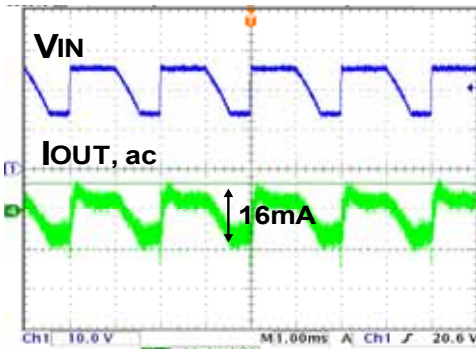

Fig 71. L1=100uH

MBI6651

Step-Down, 1A LED Driver

(c) Power supply hot plug-in waveforms

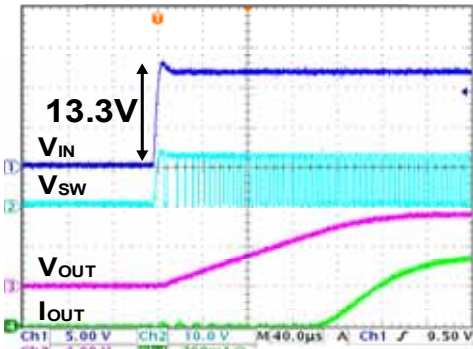

Fig 72. C_{IN}=C_{OUT}=Tantalum capacitor (10uF/50V)

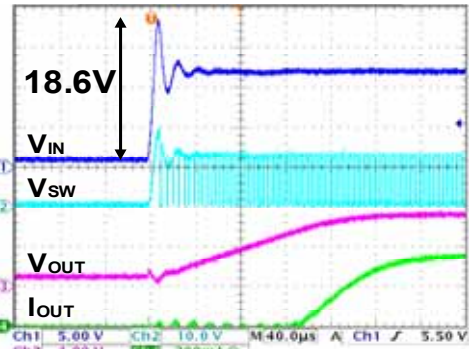

Fig 73. C_{IN}=C_{OUT}=Ceramic capacitor (2 x 4.7uF/35V)

(d) LED hot plug-in waveforms

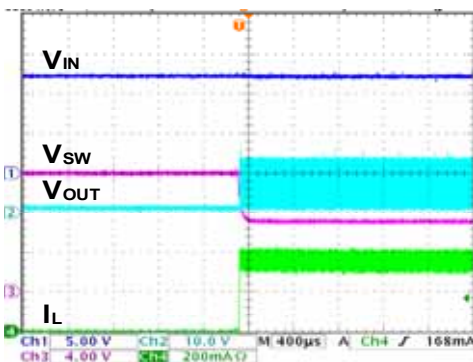

Fig 74. C_{IN}=C_{OUT}=Tantalum capacitor (10uF/50V)

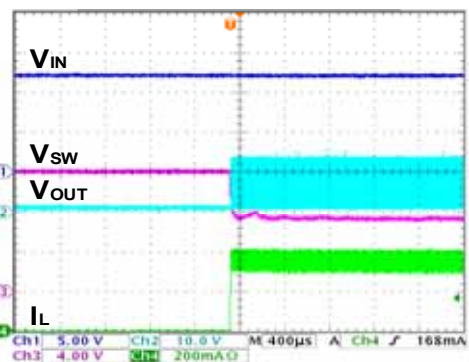

Fig 75. C_{IN}=C_{OUT}=Ceramic capacitor (2 x 4.7uF/35V)

(e) Internal Propagation Delay Time

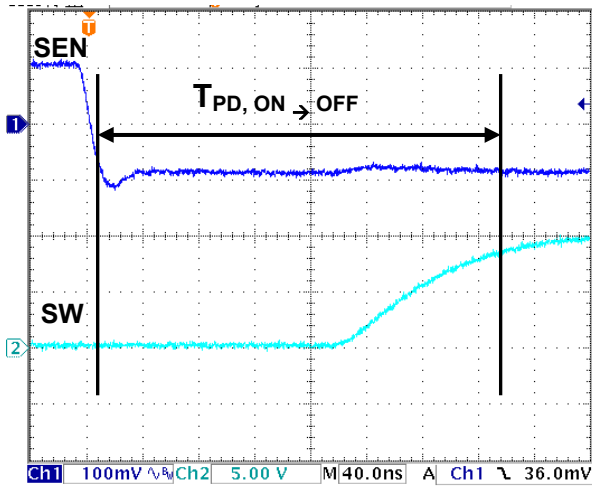

Fig 76

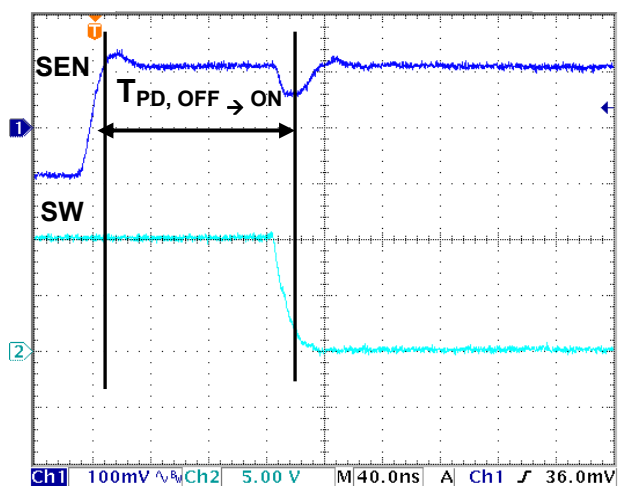

Fig 77

MBI6651

Step-Down, 1A LED Driver

Application Information

The MBI6651 is a simple and high efficient buck converter with capability to drive up to 1A of loading. The MBI6651 adopts hysteretic PFM control scheme to regulate loading and input voltage variations. The hysteretic PFM control requires no loop compensation bringing very fast load transient response and achieving excellent efficiency at light loading.

Setting Output Current

The output current (I_{OUT}) is set by an external resistor, R_{SEN} . The relationship between I_{OUT} and R_{SEN} is as below;

$$V_{SEN}=0.1V;$$

$$R_{SEN}=(V_{SEN}/I_{OUT})=(0.1V/I_{OUT});$$

$$I_{OUT}=(V_{SEN}/R_{SEN})=(0.1V/R_{SEN})$$

where R_{SEN} is the resistance of the external resistor connecting to SEN terminal and V_{SEN} is the voltage of external resistor. The magnitude of current (as a function of R_{SEN}) is around 1000mA at 0.1Ω.

Minimum Input Voltage and Start-up Protection

The minimum input voltage is the sum of the voltage drops on R_{SEN} , R_S , DCR of L1, $R_{ds(on)}$ of internal MOSFET and the total forward voltage of LEDs. The dynamic resistance of LED, R_s , is the inverse of the slope in linear forward voltage model for LED. This electrical characteristic can be provided by LED manufacturers. The equivalent impedance of the MBI6651 application circuit is shown in Fig. 78. As the input voltage is smaller than minimum input voltage such as start-up condition, the output current will be larger than the preset output current. Thus, under this circumstance, the output current is limited to 1.15 times of preset one as shown in Fig. 79.

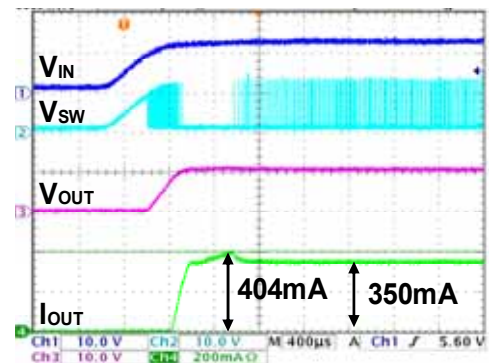
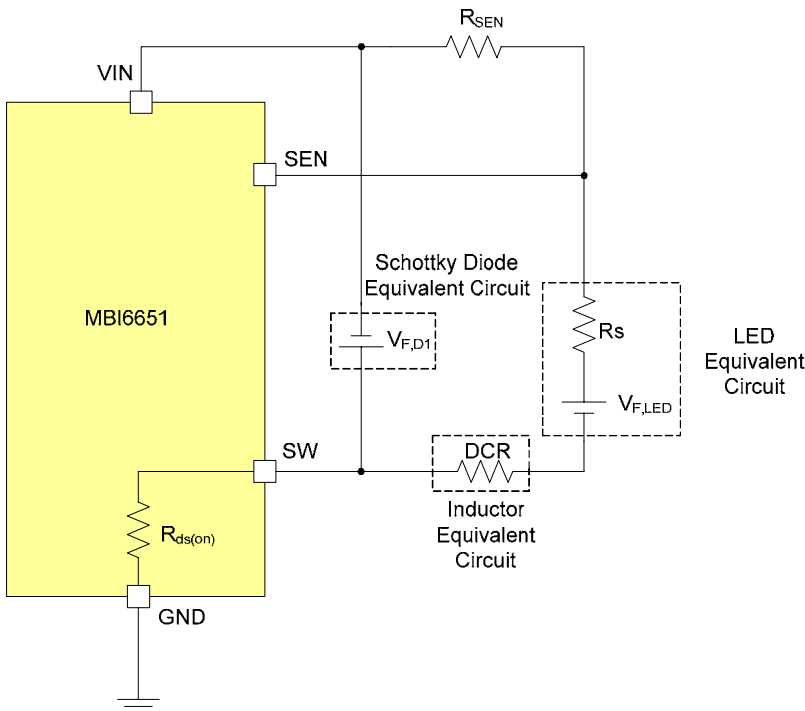

Fig. 79. The start-up waveform @ $V_{IN}=12V$, $V_{OUT}= 10.8$, $R_{SEN}=0.27$

Fig. 78. The equivalent impedance in a MBI6651 application circuit

Under Voltage Lock Out Protection

When the voltage at V_{IN} of MBI6651 is below 8.0V, the output current of MBI6651 will be turned off. When the V_{IN}

MBI6651

Step-Down, 1A LED Driver

voltage of MBI6651 resumes to 8.2V, the output current of MBI6651 will be turned on again.

Dimming

The dimming of LEDs can be performed by applying PWM signals to DIM pin. A logic low (below 0.5V) at DIM will disable the internal MOSFET and shut off the current flow to the LED array. An internal pull-up circuit ensures that the MBI6651 is ON when DIM pin is unconnected. Therefore, the need for an external pull-up resistor will be eliminated. The following Fig. 80 and 81 show good linearity in dimming application of MBI6651.

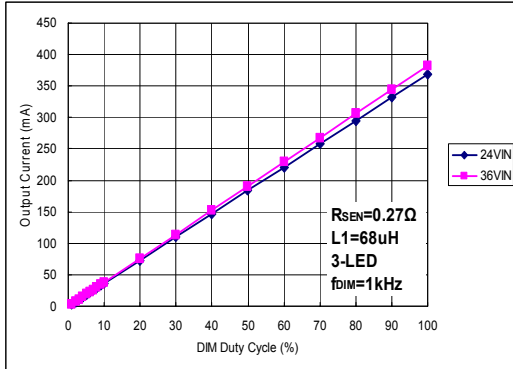

Fig. 80. DIM duty cycle: 1% ~ 100%

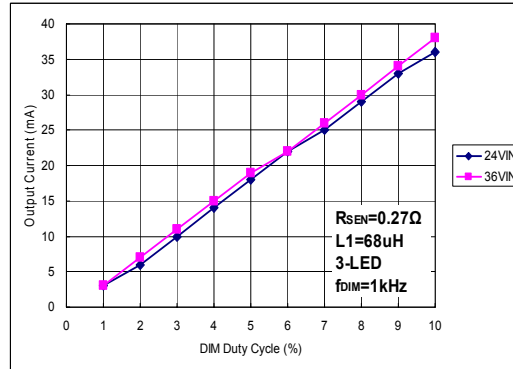

Fig. 81. DIM duty cycle: 1% ~ 10%

LED Open-Circuit Protection

When any LED connecting to the MBI6651 is open-circuited, the output current of MBI6651 will be turned off. The waveform is shown in Fig. 82.

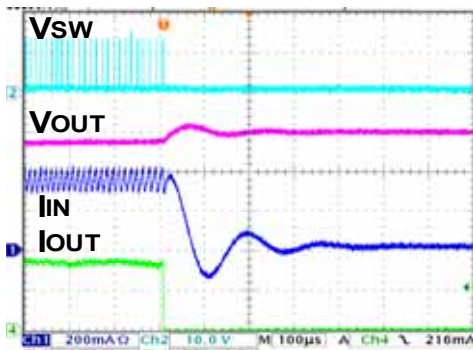

Fig. 82. Open-circuit protection

LED Short-Circuit Protection

When any LED connecting to the MBI6651 is short-circuited, the output current of MBI6651 will still be limited to its preset value as shown in Fig. 83.

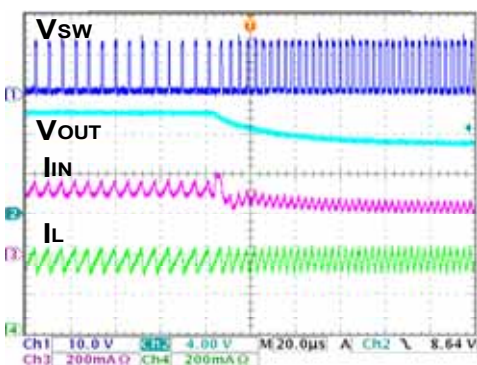

Fig. 83. Short-circuit protection

MBI6651

Step-Down, 1A LED Driver

TP Function (Thermal Protection)

When the junction temperature exceeds the threshold, T_x (165°C), TP function turns off the output current. The waveform can refer to Fig. 84. The SW stops switching and the output current will be turned off. Thus, the junction temperature starts to decrease. As soon as the temperature is below 135°C, the output current will be turned on again. The switching of on-state and off-state are at a high frequency thus the blinking is imperceptible. The average output current is limited and therefore, the driver is protected from being overheated.

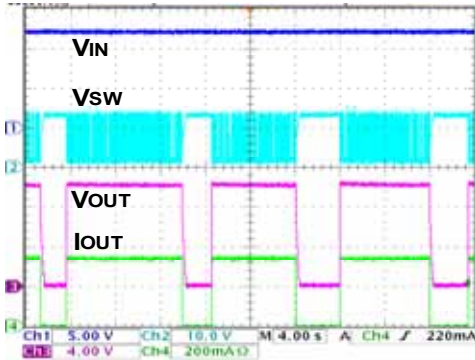

Fig. 84. Thermal protection

Design Consideration

Switching Frequency

To achieve better output current accuracy, the switching frequency should be determined by minimum on/off time of SW waveform. For example, if the duty cycle of MBI6651 is larger than 0.5, then the switching frequency should be determined by the minimum off time, and vice versa. Thus the switching frequency of MBI6651 is:

$$f_{sw} = \frac{1}{T_S} = \frac{1}{\frac{T_{OFF,min}}{(1-D)}}, \text{ when the duty cycle is larger than 0.5} \quad (1)$$

$$\text{or } f_{sw} = \frac{1}{T_S} = \frac{1}{\frac{T_{ON,min}}{D}}, \text{ when the duty cycle is smaller than 0.5.} \quad (2)$$

The switching frequency is related to efficiency (better at low frequency), the size/cost of components (smaller/cheaper at high frequency), and the amplitude of output ripple voltage and current (smaller at high frequency). The slower switching frequency comes from the large value of inductor. In many applications, the sensitivity of EMI limits the switching frequency of MBI6651. The switching frequency can be ranged from 40kHz to 1.0MHz.

LED Ripple Current

A LED constant current driver, such as MBI6651, is designed to control the current through the cascaded LED, instead of the voltage across it. Higher LED ripple current allows the use of smaller inductance, smaller output capacitance and even without an output capacitor. The advantages of higher LED ripple current are to minimize PCB size and reduce cost because of no output capacitor. Lower LED ripple current requires larger inductance, and output capacitor. The advantages of lower LED ripple current are to extend LED life time and to reduce heating of LED. The recommended ripple current is from 5% to 20% of normal LED current.

MBI6651

Step-Down, 1A LED Driver

Component Selection

Inductor Selection

The inductance is determined by two factors: the switching frequency and the inductor ripple current. The calculation of the inductance, L_1 , can be described as

$$L_1 > (V_{IN} - V_{OUT} - V_{SEN} - (R_{ds(on)} \times I_{OUT})) \times \frac{D}{f_{SW} \times \Delta I_L}$$

where

$R_{ds(on)}$ is the on-resistance of internal MOSFET of the MBI6651. The typical is 0.45Ω at $12V_{IN}$.

D is the duty cycle of the MBI6651, $D = V_{OUT}/V_{IN}$.

f_{SW} is the switching frequency of the MBI6651.

I_L is the ripple current of inductor, $I_L = (1.15 \times I_{OUT}) - (0.85 \times I_{OUT}) = 0.3 \times I_{OUT}$.

When selecting an inductor, not only the inductance but also the saturation current that should be considered as the factors to affect the performance of module. In general, it is recommended to choose an inductor with 1.5 times of LED current as the saturation current. Also, the larger inductance gains the better line/load regulation. However, the inductance and saturation current become a trade-off at the same inductor size. An inductor with shield is recommended to reduce the EMI interference, however, this is another trade-off with heat dissipation.

Schottky Diode Selection

The MBI6651 needs a flywheel diode, D_1 , to carry the inductor current when the MOSFET is off. The recommended flywheel diode is schottky diode with low forward voltage for better efficiency. Two factors determine the selection of schottky diode. One is the maximum reverse voltage. The recommended rated voltage of the reverse voltage is at least 1.5 times of input voltage. The other is the maximum forward current, which works when the MOSFET is off. And the recommended forward current is 1.5 times of output current. Users should carefully choose an appropriate schottky diode which can perform low leakage current at high temperature.

Input Capacitor Selection

The input capacitor, C_{IN} , can supply pulses of current for the MBI6651 when the MOSFET is ON. And C_{IN} is charged by input voltage when the MOSFET is OFF. As the input voltage is lower than the tolerable input voltage, the internal MOSFET of the MBI6651 remains constantly ON, and the LED current is limited to 1.15 times of normal current. The recommended value of input capacitor is 10uF to stabilize the lighting system. The rated voltage of input capacitor should be at least 1.5 times of input voltage. Compromising availability and cost, an electrolytic capacitor is more frequently used.

For system stability, placing the C_{IN} to the VIN pin of MBI6651 as close as possible is recommended. However, the actual PCB layout and size might limit this applicability. Therefore, it is suggested to position a tiny bypass capacitor, C_{BP} to the VIN and GND pins of MBI6651 as close as possible, and parallel with the C_{IN} to enhance power noise injection capability. The recommend capacitance range is from 0.1uF to 1uF, and ceramic type is a good option.

MBI6651

Step-Down, 1A LED Driver

The rated voltage, capacitance, and the maximum ripple current are the major concerns when selecting an input capacitor. It is important to carefully select the specification of maximum ripple current of input capacitor when in application. Both the IC and the capacitor may be damaged, if the rated ripple current of the selected capacitor is insufficient. In general, the ripple current is related to the inductor ripple current. The maximum ripple current specification should be larger than 1.3 times of the inductor ripple current.

A tantalum or ceramic capacitor can also be used as an input capacitor. The advantages of tantalum capacitor are high capacitance and low ESR. The advantages of ceramic capacitor are high frequency characteristic, small size and low cost. Due to low ESR characteristic of ceramic capacitor, please do not use hot plugging. Users can choose an appropriate one for their applications.

Output Capacitor Selection (Optional)

A capacitor paralleled with cascaded LED can reduce the LED ripple current and allow smaller inductance.

PCB Layout Consideration

To enhance the efficiency and stabilize the system, careful considerations of PCB layout is important. There are several factors should be considered.

1. A complete ground area is helpful to eliminate the switching noise.
2. Keep the IC's GND pin and the ground leads of input and output filter capacitors less than 5mm.
3. To maximize output power efficiency and minimize output ripple voltage, use a ground plane and solder the IC's GND pin directly to the ground plane.
4. To stabilize the system, the heat sink of the MBI6651 is recommended to connect to ground plane directly.
5. Enhance the heat dissipation, the area of ground plane, which IC's heat sink is soldered on, should be as large as possible.
6. The input capacitor should be placed to IC's VIN pin as close as possible.
7. To avoid the parasitic effect of trace, the R_{SEN} should be placed to IC's VIN and SEN pins as close as possible.
8. The area, which is composed of IC's SW pin, schottky diode and inductor, should be wide and short.
9. The path, which flows large current, should be wide and short to eliminate the parasite element.
10. When SW is ON/OFF, the direction of power loop should keep the same way to enhance the efficiency. The sketch is shown as Fig. 85.
11. To avoid unexpected damage or malfunction to the driver board, users should pay attention to the quality of soldering in the PCB by checking if cold welding or cold joint happens between the pins of IC and the PCB.

MBI6651

Step-Down, 1A LED Driver

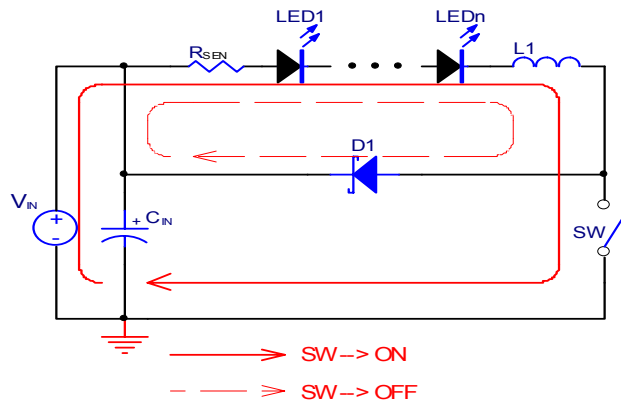

Fig. 85. Power loop of MBI6651

PCB Layout

Fig. 86. is the recommended layout diagram of the MBI6651 GSD package.

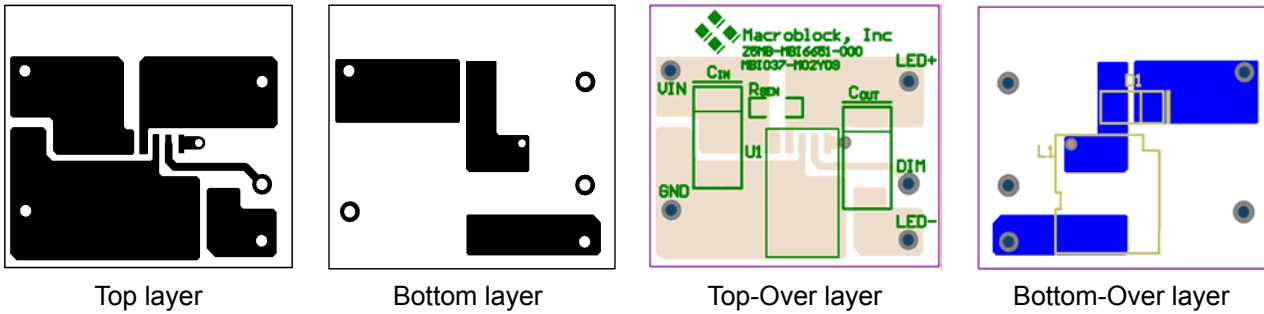

Fig. 86. The layout diagram of the MBI6651 GSD

MBI6651

Step-Down, 1A LED Driver

Soldering Process of "Pb-free" Package Plating*

Macroblock has defined "Pb-Free" to mean semiconductor products that are compatible with the current RoHS requirements and selected 100% pure tin (Sn) to provide forward and backward compatibility with both the current industry-standard SnPb-based soldering processes and higher-temperature Pb-free processes. Pure tin is widely accepted by customers and suppliers of electronic devices in Europe, Asia and the US as the lead-free surface finish of choice to replace tin-lead. Also, it adopts tin/lead (SnPb) solder paste, and please refer to the JEDEC J-STD-020C for the temperature of solder bath. However, in the whole Pb-free soldering processes and materials, 100% pure tin (Sn) will all require from 245 °C to 260 °C for proper soldering on boards, referring to JEDEC J-STD-020C as shown below.

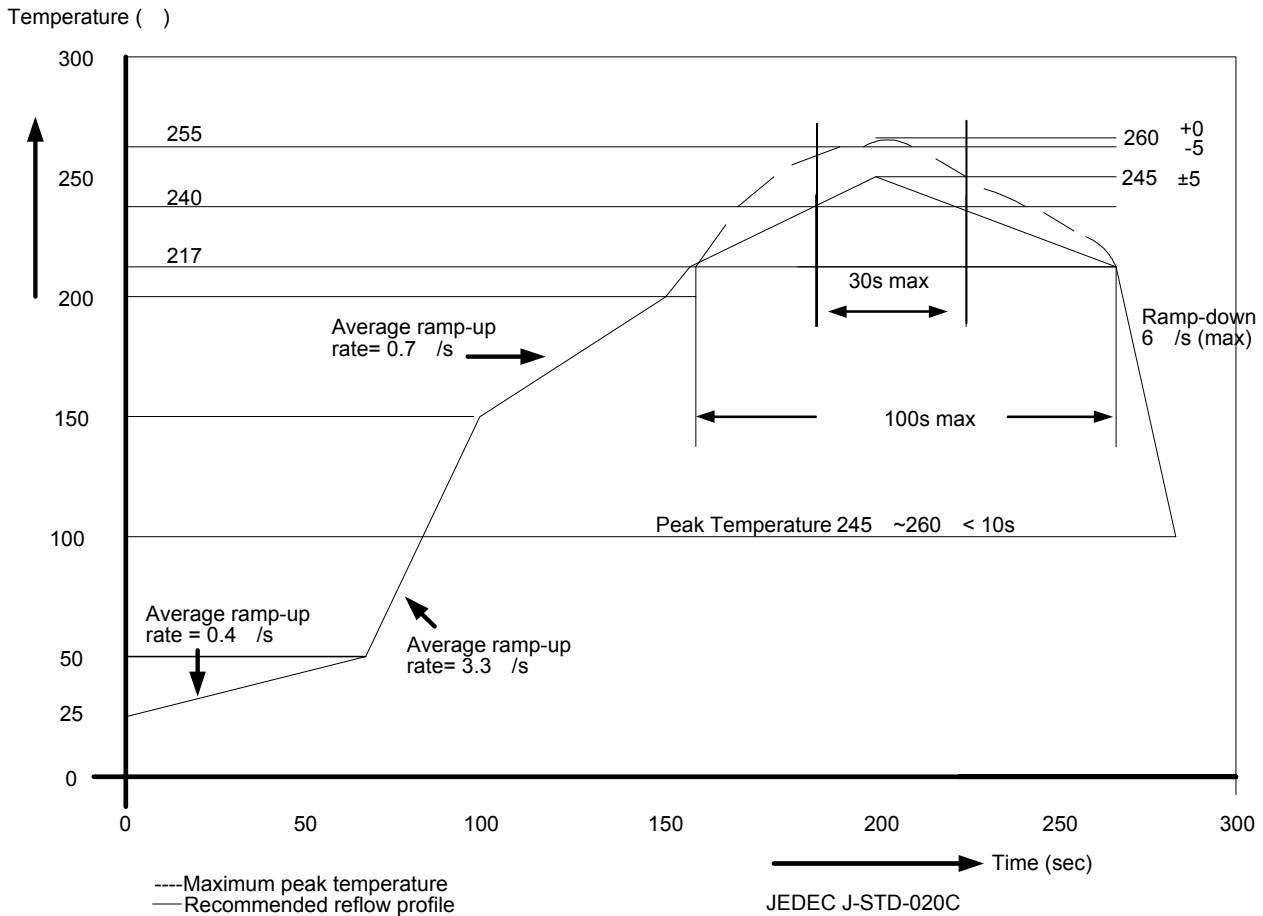

Package Thickness	Volume mm ³ <350	Volume mm ³ 350-2000	Volume mm ³ 2000
<1.6mm	260 +0 °C	260 +0 °C	260 +0 °C
1.6mm – 2.5mm	260 +0 °C	250 +0 °C	245 +0 °C
2.5mm	250 +0 °C	245 +0 °C	245 +0 °C

*Note: For details, please refer to Macroblock's "Policy on Pb-free & Green Package".

MBI6651

Step-Down, 1A LED Driver

Package Power Dissipation (PD)

The maximum power dissipation, $P_D(max)=(T_j-T_a)/R_{th(j-a)}$, decreases as the ambient temperature increases.

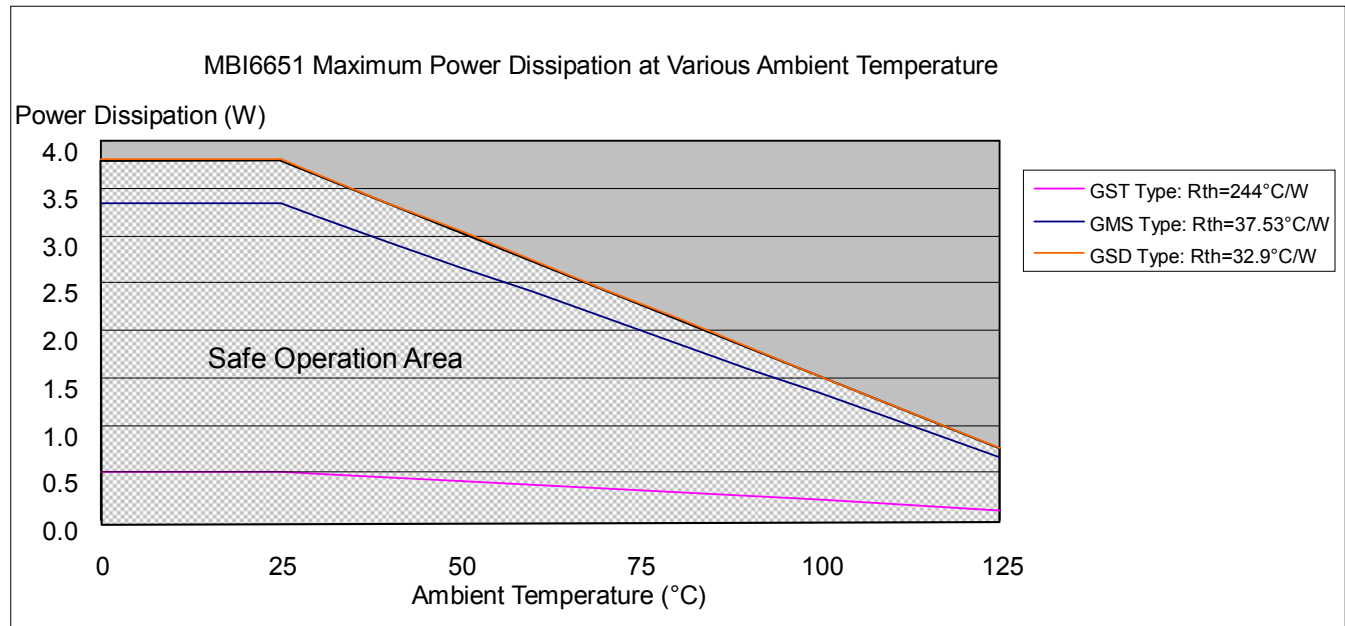

MBI6651

Step-Down, 1A LED Driver

Outline Drawing

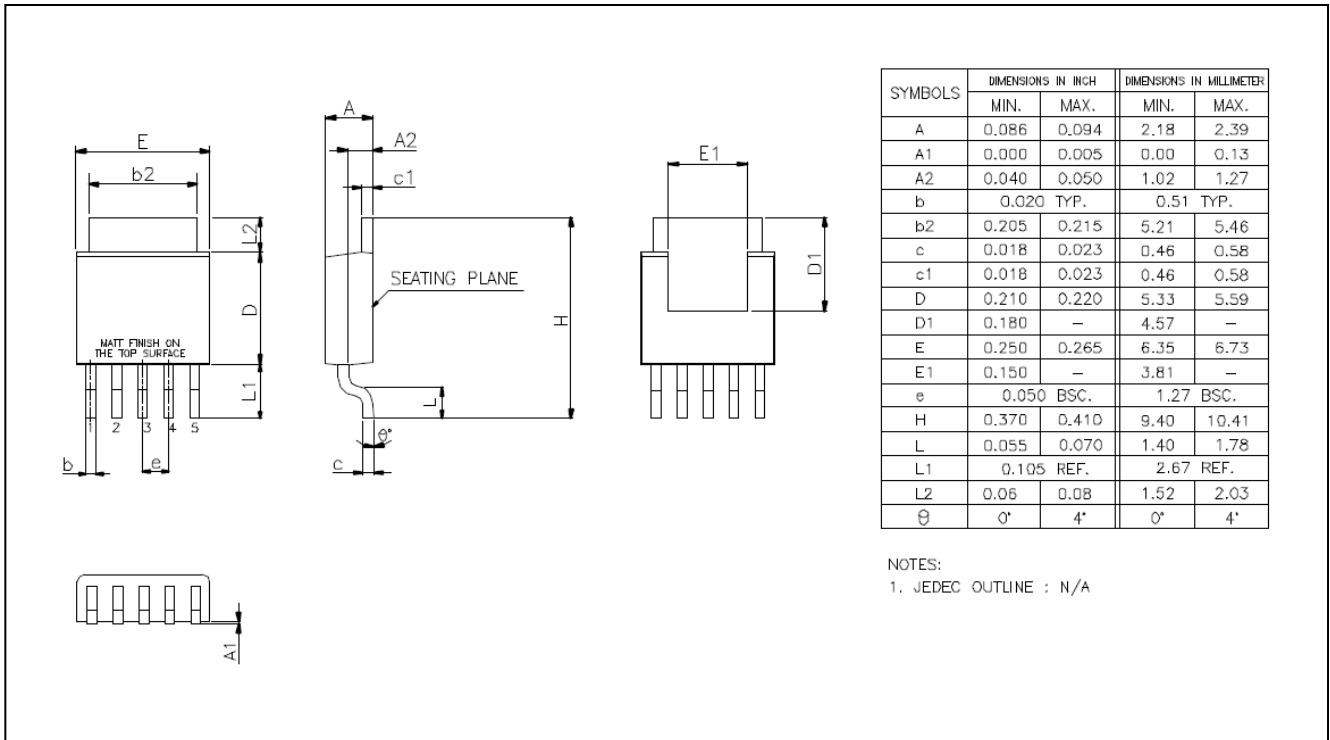

MBI6651 GSD: TO-252 Outline Drawing

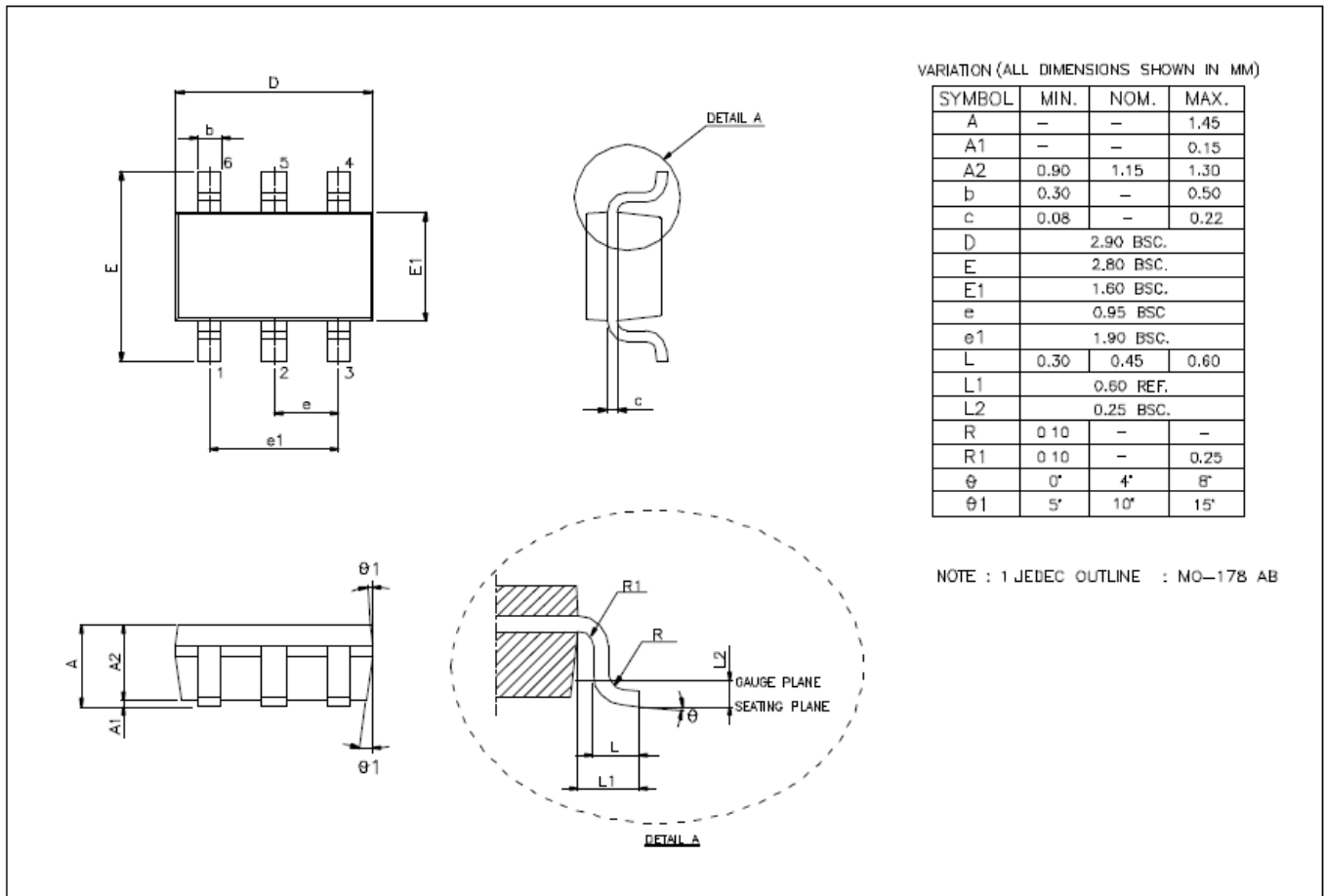

MBI6651 GST: SOT-23 Outline Drawing

MBI6651

Step-Down, 1A LED Driver

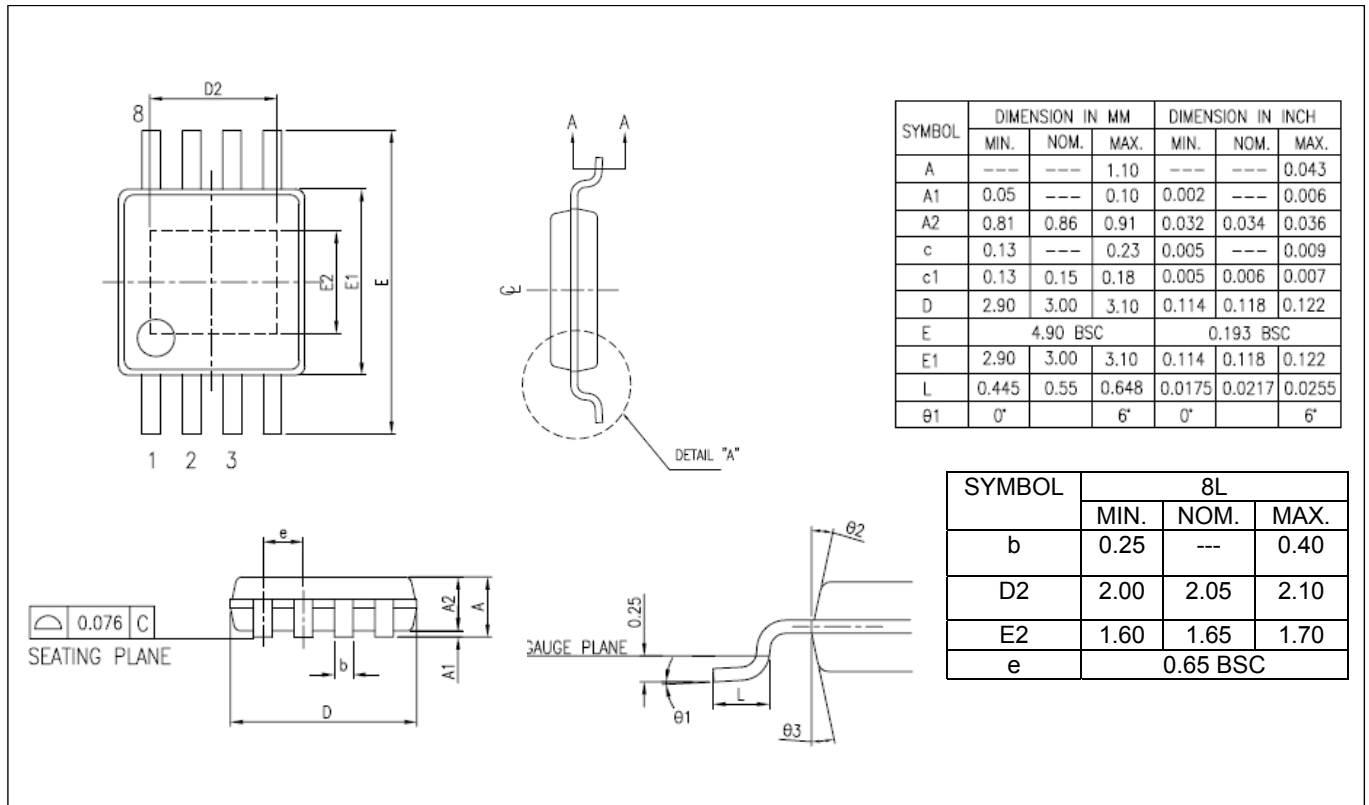

MBI6651 GMS: MSOP-8L Outline Drawing

Note1: The unit for the outline drawing is mm.

Note2: Please use the maximum dimensions for the thermal pad layout. To avoid the short circuit risk, the vias or circuit traces shall not pass through the maximum area of thermal pad.

MBI6651

Step-Down, 1A LED Driver

Product Top Mark Information

GSD(TO-252)/GST(SOT-23)

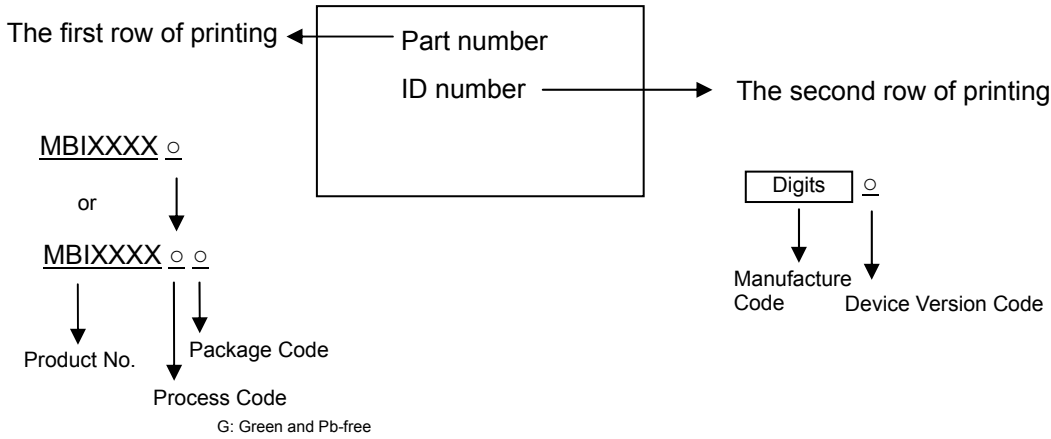

GMS(MSOP-8L)

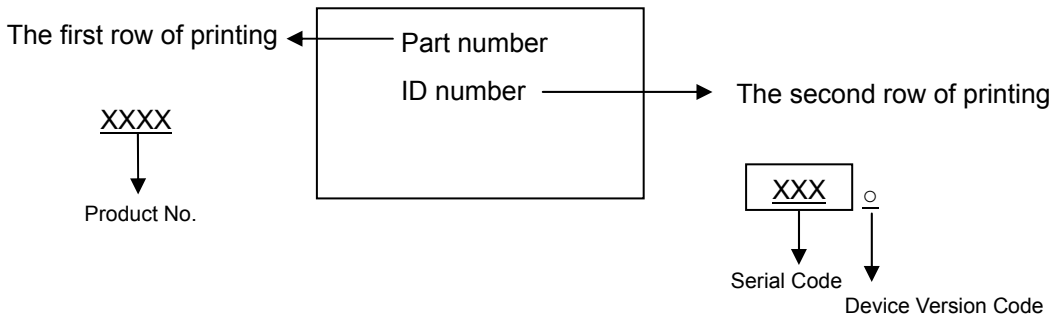

Product Revision History

Datasheet version	Device Version Code
VA.00	A

Product Ordering Information

Part Number	“Pb-free” Package Type	Weight (g)
MBI6651GSD	TO-252-5L	0.282g
MBI6651GST	SOT-23-6L	0.016g
MBI6651GMS	MSOP-8L	0.0233g

Disclaimer

Macroblock reserves the right to make changes, corrections, modifications, and improvements to their products and documents or discontinue any product or service. Customers are advised to consult their sales representative for the latest product information before ordering. All products are sold subject to the terms and conditions supplied at the time of order acknowledgement, including those pertaining to warranty, patent infringement, and limitation of liability.

Macroblock's products are not designed to be used as components in device intended to support or sustain life or in military applications. Use of Macroblock's products in components intended for surgical implant into the body, or other applications in which failure of Macroblock's products could create a situation where personal death or injury may occur, is not authorized without the express written approval of the Managing Director of Macroblock.

Macroblock will not be held liable for any damages or claims resulting from the use of its products in medical and military applications.

All text, images, logos and information contained on this document is the intellectual property of Macroblock.

Unauthorized reproduction, duplication, extraction, use or disclosure of the above mentioned intellectual property will be deemed as infringement.