

# AMC1351-Q1 Automotive, Precision, 5-V Input, Reinforced Isolated Amplifier

## 1 Features

- AEC-Q100 qualified for automotive applications:
  - Temperature grade 1:  $-40^{\circ}\text{C}$  to  $+125^{\circ}\text{C}$ ,  $T_A$
- **Functional Safety-Capable**
  - [Documentation available to aid functional safety system design](#)
- Linear input voltage range:  $-0.25\text{ V}$  to  $5\text{ V}$
- High input impedance:  $1.25\text{ M}\Omega$  (typ)
- Fixed gain:  $0.4\text{ V/V}$
- Low DC errors:
  - Offset error  $\pm 1.5\text{ mV}$  (max)
  - Offset drift:  $\pm 15\text{ }\mu\text{V}/^{\circ}\text{C}$  (max)
  - Gain error:  $\pm 0.2\%$  (max)
  - Gain drift:  $\pm 35\text{ ppm}/^{\circ}\text{C}$  (max)
  - Nonlinearity  $\pm 0.02\%$  (max)
- Operation on high-side and low-side:  $3.3\text{ V}$  or  $5\text{ V}$
- High CMTI:  $100\text{ kV}/\mu\text{s}$  (min)
- Fail-safe output
- Safety-related certifications:
  - $7070\text{-V}_{\text{PK}}$  reinforced isolation per DIN VDE V 0884-11: 2017-01
  - $5000\text{-V}_{\text{RMS}}$  isolation for 1 minute per UL1577

## 2 Applications

- Isolated voltage sensing in:
  - [Traction inverters](#)
  - [Onboard chargers](#)
  - [DC/DC converters](#)
  - [HEV/EV DC chargers](#)

## 3 Description

The AMC1351-Q1 is a precision, isolated amplifier with an output separated from the input circuitry by an isolation barrier that is highly resistant to magnetic interference. This barrier is certified to provide reinforced galvanic isolation of up to  $5\text{ kV}_{\text{RMS}}$  according to VDE V 0884-11 and UL1577, and supports a working voltage of up to  $1.5\text{ kV}_{\text{RMS}}$ .

The isolation barrier separates parts of the system that operate on different common-mode voltage levels and protects the low-voltage side from potentially harmful voltages and damage.

The high-impedance input of the AMC1351-Q1 is optimized for connection to high-impedance resistive dividers or other voltage signal sources with high output resistance. The excellent accuracy and low temperature drift supports accurate DC voltage sensing in DC/DC converters, frequency inverters, motor-drives, or other applications that must support high common-mode voltages.

The AMC1351-Q1 is offered in a wide-body 8-pin SOIC package and is AEC-Q100 qualified for automotive applications and supports the temperature range from  $-40^{\circ}\text{C}$  to  $+125^{\circ}\text{C}$ .

### Device Information<sup>(1)</sup>

PART NUMBER	PACKAGE	BODY SIZE (NOM)
AMC1351-Q1	SOIC (8)	5.85 mm × 7.50 mm

(1) For all available packages, see the orderable addendum at the end of the data sheet.

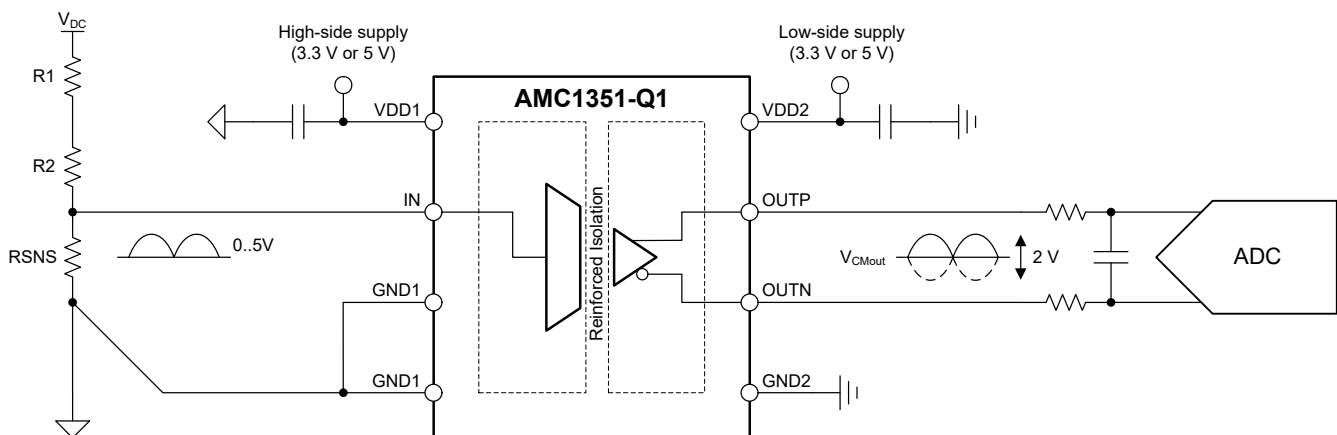

Typical Application



## Table of Contents

<b>1 Features</b> .....	<b>1</b>	7.2 Functional Block Diagram.....	<b>19</b>
<b>2 Applications</b> .....	<b>1</b>	7.3 Feature Description.....	<b>19</b>
<b>3 Description</b> .....	<b>1</b>	7.4 Device Functional Modes.....	<b>21</b>
<b>4 Revision History</b> .....	<b>2</b>	<b>8 Application and Implementation</b> .....	<b>22</b>
<b>5 Pin Configuration and Functions</b> .....	<b>3</b>	8.1 Application Information.....	<b>22</b>
<b>6 Specifications</b> .....	<b>4</b>	8.2 Typical Application.....	<b>22</b>
6.1 Absolute Maximum Ratings.....	<b>4</b>	8.3 What To Do and What Not To Do.....	<b>25</b>
6.2 ESD Ratings.....	<b>4</b>	<b>9 Power Supply Recommendations</b> .....	<b>26</b>
6.3 Recommended Operating Conditions.....	<b>4</b>	<b>10 Layout</b> .....	<b>27</b>
6.4 Thermal Information.....	<b>5</b>	10.1 Layout Guidelines.....	<b>27</b>
6.5 Power Ratings.....	<b>5</b>	10.2 Layout Example.....	<b>27</b>
6.6 Insulation Specifications.....	<b>6</b>	<b>11 Device and Documentation Support</b> .....	<b>28</b>
6.7 Safety-Related Certifications.....	<b>7</b>	11.1 Documentation Support.....	<b>28</b>
6.8 Safety Limiting Values.....	<b>7</b>	11.2 Receiving Notification of Documentation Updates..	<b>28</b>
6.9 Electrical Characteristics.....	<b>8</b>	11.3 Support Resources.....	<b>28</b>
6.10 Switching Characteristics.....	<b>10</b>	11.4 Trademarks.....	<b>28</b>
6.11 Timing Diagram.....	<b>10</b>	11.5 Electrostatic Discharge Caution.....	<b>28</b>
6.12 Insulation Characteristics Curves.....	<b>11</b>	11.6 Glossary.....	<b>28</b>
6.13 Typical Characteristics.....	<b>12</b>	<b>12 Mechanical, Packaging, and Orderable Information</b> .....	<b>28</b>
<b>7 Detailed Description</b> .....	<b>19</b>		
7.1 Overview.....	<b>19</b>		

## 4 Revision History

NOTE: Page numbers for previous revisions may differ from page numbers in the current version.

DATE	REVISION	NOTES
December 2021	*	Initial Release

## 5 Pin Configuration and Functions

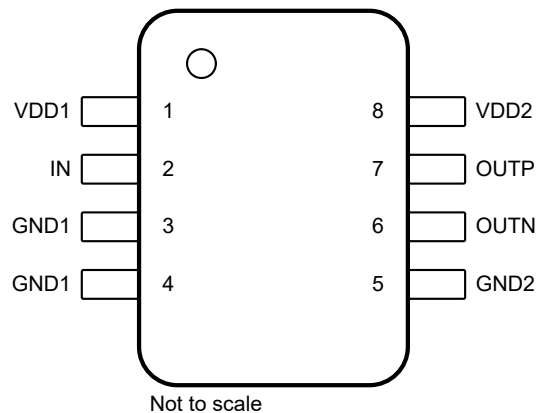

**Figure 5-1. DWV Package, 8-Pin SOIC (Top View)**

**Table 5-1. Pin Functions**

PIN		TYPE	DESCRIPTION
NO.	NAME		
1	VDD1	High-side power	High-side power supply <sup>(1)</sup>
2	IN	Analog input	Analog input
3	GND1	High-side ground	High-side analog ground reference for input amplifier. Connect to pin 4. Do not leave unconnected.
4	GND1	High-side ground	High-side analog ground
5	GND2	Low-side ground	Low-side analog ground
6	OUTN	Analog output	Inverting analog output
7	OUTP	Analog output	Noninverting analog output
8	VDD2	Low-side power	Low-side power supply <sup>(1)</sup>

(1) See the [Power Supply Recommendations](#) section for power-supply decoupling recommendations.

## 6 Specifications

### 6.1 Absolute Maximum Ratings

see<sup>(1)</sup>

		MIN	MAX	UNIT
Power-supply voltage	High-side VDD1 to GND1	-0.3	6.5	V
	Low-side VDD2 to GND2	-0.3	6.5	
Analog input voltage	IN	-1	15	V
Analog output voltage	OUTP, OUTN	GND2 - 0.5	VDD2 + 0.5	V
Input current	Continuous, any pin except power-supply pins	-10	10	mA
Temperature	Junction, T <sub>J</sub>		150	°C
	Storage, T <sub>stg</sub>	-65	150	

- (1) Operation outside the *Absolute Maximum Ratings* may cause permanent device damage. *Absolute Maximum Ratings* do not imply functional operation of the device at these or any other conditions beyond those listed under *Recommended Operating Conditions*. If used outside the Recommended Operating Conditions but within the Absolute Maximum Ratings, the device may not be fully functional, and this may affect device reliability, functionality, performance, and shorten the device lifetime

### 6.2 ESD Ratings

			VALUE	UNIT
V <sub>(ESD)</sub>	Electrostatic discharge	Human-body model (HBM), per AEC Q100-002 <sup>(1)</sup> , HBM ESD classification level 2	±2000	V
		Charged-device model (CDM), per AEC Q100-011, CDM ESD classification level C6	±1000	

- (1) AEC Q100-002 indicates that HBM stressing shall be in accordance with the ANSI/ESDA/JEDEC JS-001 specification.

### 6.3 Recommended Operating Conditions

over operating ambient temperature range (unless otherwise noted)

				MIN	NOM	MAX	UNIT
<b>POWER SUPPLY</b>							
VDD1	High-side power-supply	VDD1 to GND1		3	5	5.5	V
VDD2	Low-side power-supply	VDD2 to GND2		3	3.3	5.5	V
<b>ANALOG INPUT</b>							
V <sub>Clipping</sub>	Input voltage before clipping output				6.25		V
V <sub>FSR</sub>	Specified linear full-scale voltage			-0.25		5	V
<b>ANALOG OUTPUT</b>							
C <sub>LOAD</sub>	Capacitive load	On OUTP or OUTN to GND2				500	pF
		OUTP to OUTN				250	
R <sub>LOAD</sub>	Resistive load	On OUTP or OUTN to GND2			10	1	kΩ
<b>TEMPERATURE RANGE</b>							
T <sub>A</sub>	Specified ambient temperature			-40		125	°C

## 6.4 Thermal Information

THERMAL METRIC <sup>(1)</sup>		AMC1351-Q1	UNIT
		DWV (SOIC)	
		8 PINS	
R <sub>θJA</sub>	Junction-to-ambient thermal resistance	84.6	°C/W
R <sub>θJC(top)</sub>	Junction-to-case (top) thermal resistance	28.3	°C/W
R <sub>θJB</sub>	Junction-to-board thermal resistance	41.1	°C/W
ψ <sub>JT</sub>	Junction-to-top characterization parameter	4.9	°C/W
ψ <sub>JB</sub>	Junction-to-board characterization parameter	39.1	°C/W
R <sub>θJC(bot)</sub>	Junction-to-case (bottom) thermal resistance	n/a	°C/W

(1) For more information about traditional and new thermal metrics, see the [Semiconductor and IC Package Thermal Metrics](#) application report.

## 6.5 Power Ratings

PARAMETER		TEST CONDITIONS	VALUE	UNIT
P <sub>D</sub>	Maximum power dissipation (both sides)	VDD1 = VDD2 = 5.5 V	96	mW
P <sub>D1</sub>	Maximum power dissipation (high-side)	VDD1 = 3.6 V	29	mW
		VDD1 = 5.5 V	51	
P <sub>D2</sub>	Maximum power dissipation (low-side)	VDD2 = 3.6 V	26	mW
		VDD2 = 5.5 V	45	

## 6.6 Insulation Specifications

over operating ambient temperature range (unless otherwise noted)

PARAMETER		TEST CONDITIONS	VALUE	UNIT
<b>GENERAL</b>				
CLR	External clearance <sup>(1)</sup>	Shortest pin-to-pin distance through air	≥ 8.5	mm
CPG	External creepage <sup>(1)</sup>	Shortest pin-to-pin distance across the package surface	≥ 8.5	mm
DTI	Distance through insulation	Minimum internal gap (internal clearance) of the double insulation	≥ 0.021	mm
CTI	Comparative tracking index	DIN EN 60112 (VDE 0303-11); IEC 60112	≥ 600	V
	Material group	According to IEC 60664-1	I	
	Overvoltage category per IEC 60664-1	Rated mains voltage ≤ 600 V <sub>RMS</sub>	I-IV	
		Rated mains voltage ≤ 1000 V <sub>RMS</sub>	I-III	
<b>DIN VDE V 0884-11 (VDE V 0884-11): 2017-01</b>				
V <sub>IORM</sub>	Maximum repetitive peak isolation voltage	At AC voltage	2120	V <sub>PK</sub>
V <sub>IOWM</sub>	Maximum-rated isolation working voltage	At AC voltage (sine wave)	1500	V <sub>RMS</sub>
		At DC voltage	2120	V <sub>DC</sub>
V <sub>IOTM</sub>	Maximum transient isolation voltage	V <sub>TEST</sub> = V <sub>IOTM</sub> , t = 60 s (qualification test)	7070	V <sub>PK</sub>
		V <sub>TEST</sub> = 1.2 × V <sub>IOTM</sub> , t = 1 s (100% production test)	8480	
V <sub>IOSM</sub>	Maximum surge isolation voltage <sup>(2)</sup>	Test method per IEC 60065, 1.2/50-μs waveform, V <sub>TEST</sub> = 1.6 × V <sub>IOSM</sub> = 12800 V <sub>PK</sub> (qualification)	8000	V <sub>PK</sub>
q <sub>pd</sub>	Apparent charge <sup>(3)</sup>	Method a, after input/output safety test subgroups 2 and 3, V <sub>ini</sub> = V <sub>IOTM</sub> , t <sub>ini</sub> = 60 s, V <sub>pd(m)</sub> = 1.2 × V <sub>IORM</sub> , t <sub>m</sub> = 10 s	≤ 5	pC
		Method a, after environmental tests subgroup 1, V <sub>ini</sub> = V <sub>IOTM</sub> , t <sub>ini</sub> = 60 s, V <sub>pd(m)</sub> = 1.6 × V <sub>IORM</sub> , t <sub>m</sub> = 10 s	≤ 5	
		Method b1, at routine test (100% production) and preconditioning (type test), V <sub>ini</sub> = V <sub>IOTM</sub> , t <sub>ini</sub> = 1 s, V <sub>pd(m)</sub> = 1.875 × V <sub>IORM</sub> , t <sub>m</sub> = 1 s	≤ 5	
C <sub>IO</sub>	Barrier capacitance, input to output <sup>(4)</sup>	V <sub>IO</sub> = 0.5 V <sub>PP</sub> at 1 MHz	~1.5	pF
R <sub>IO</sub>	Insulation resistance, input to output <sup>(4)</sup>	V <sub>IO</sub> = 500 V at T <sub>A</sub> = 25°C	> 10 <sup>12</sup>	Ω
		V <sub>IO</sub> = 500 V at 100°C ≤ T <sub>A</sub> ≤ 125°C	> 10 <sup>11</sup>	
		V <sub>IO</sub> = 500 V at T <sub>S</sub> = 150°C	> 10 <sup>9</sup>	
	Pollution degree		2	
	Climatic category		55/125/21	
<b>UL1577</b>				
V <sub>ISO</sub>	Withstand isolation voltage	V <sub>TEST</sub> = V <sub>ISO</sub> = 5000 V <sub>RMS</sub> or 7071 V <sub>DC</sub> , t = 60 s (qualification), V <sub>TEST</sub> = 1.2 × V <sub>ISO</sub> = 6000 V <sub>RMS</sub> , t = 1 s (100% production test)	5000	V <sub>RMS</sub>

- (1) Apply creepage and clearance requirements according to the specific equipment isolation standards of an application. Care must be taken to maintain the creepage and clearance distance of a board design to ensure that the mounting pads of the isolator on the printed circuit board (PCB) do not reduce this distance. Creepage and clearance on a PCB become equal in certain cases. Techniques such as inserting grooves, ribs, or both on a PCB are used to help increase these specifications.
- (2) Testing is carried out in air or oil to determine the intrinsic surge immunity of the isolation barrier.
- (3) Apparent charge is electrical discharge caused by a partial discharge (pd).
- (4) All pins on each side of the barrier are tied together, creating a two-pin device.

## 6.7 Safety-Related Certifications

VDE	UL
Certified according to DIN VDE V 0884-11 (VDE V 0884-11): 2017-01, DIN EN 60950-1 (VDE 0805 Teil 1): 2014-08, and DIN EN 60065 (VDE 0860): 2005-11	Recognized under 1577 component recognition
Reinforced insulation	Single protection
Certificate number: pending	File number: E181974

## 6.8 Safety Limiting Values

Safety limiting<sup>(1)</sup> intends to minimize potential damage to the isolation barrier upon failure of input or output circuitry. A failure of the I/O can allow low resistance to ground or the supply and, without current limiting, dissipate sufficient power to over-heat the die and damage the isolation barrier potentially leading to secondary system failures.

PARAMETER		TEST CONDITIONS	MIN	TYP	MAX	UNIT
I <sub>S</sub>	Safety input, output, or supply current	R <sub>θJA</sub> = 84.6°C/W, VDDx = 5.5 V, T <sub>J</sub> = 150°C, T <sub>A</sub> = 25°C			270	mA
		R <sub>θJA</sub> = 84.6°C/W, VDDx = 3.6 V, T <sub>J</sub> = 150°C, T <sub>A</sub> = 25°C			410	
P <sub>S</sub>	Safety input, output, or total power	R <sub>θJA</sub> = 84.6°C/W, T <sub>J</sub> = 150°C, T <sub>A</sub> = 25°C			1480	mW
T <sub>S</sub>	Maximum safety temperature				150	°C

- (1) The maximum safety temperature, T<sub>S</sub>, has the same value as the maximum junction temperature, T<sub>J</sub>, specified for the device. The I<sub>S</sub> and P<sub>S</sub> parameters represent the safety current and safety power, respectively. Do not exceed the maximum limits of I<sub>S</sub> and P<sub>S</sub>. These limits vary with the ambient temperature, T<sub>A</sub>.

The junction-to-air thermal resistance, R<sub>θJA</sub>, in the [Thermal Information](#) table is that of a device installed on a high-K test board for leaded surface-mount packages. Use these equations to calculate the value for each parameter:

T<sub>J</sub> = T<sub>A</sub> + R<sub>θJA</sub> × P, where P is the power dissipated in the device.

T<sub>J(max)</sub> = T<sub>S</sub> = T<sub>A</sub> + R<sub>θJA</sub> × P<sub>S</sub>, where T<sub>J(max)</sub> is the maximum junction temperature.

P<sub>S</sub> = I<sub>S</sub> × VDD<sub>max</sub>, where VDD<sub>max</sub> is the maximum supply voltage for high-side and low-side.

## 6.9 Electrical Characteristics

minimum and maximum specifications apply from  $T_A = -40^\circ\text{C}$  to  $+125^\circ\text{C}$ ,  $V_{DD1} = 3.0\text{ V}$  to  $5.5\text{ V}$ ,  $V_{DD2} = 3.0\text{ V}$  to  $5.5\text{ V}$ ,  $I_N = -0.25\text{ V}$  to  $+5\text{ V}$  (unless otherwise noted); typical specifications are at  $T_A = 25^\circ\text{C}$ ,  $V_{DD1} = 5\text{ V}$ , and  $V_{DD2} = 3.3\text{ V}$

PARAMETER		TEST CONDITIONS	MIN	TYP	MAX	UNIT
<b>ANALOG INPUT</b>						
$V_{OS}$	Offset voltage <sup>(2)</sup>	$T_A = 25^\circ\text{C}$ , $I_N = \text{GND1}$ , $4.5\text{ V} \leq V_{DD1} \leq 5.5\text{ V}$ <sup>(1)</sup>	-1.5	$\pm 0.3$	1.5	mV
		$T_A = 25^\circ\text{C}$ , $I_N = \text{GND1}$ , $3.0\text{ V} \leq V_{DD1} \leq 5.5\text{ V}$ <sup>(3)</sup>	-2.5	-0.8	2.5	
$\Delta V_{OS}$	Offset voltage long-term stability	10 years at $T_A = 55^\circ\text{C}$		0 <sup>(7)</sup>		mV
$TCV_{OS}$	Offset voltage thermal drift <sup>(5)</sup>	$I_N = \text{GND1}$	-15	$\pm 3$	15	$\mu\text{V}/^\circ\text{C}$
$\Delta TCV_{OS}$	Offset voltage thermal drift long-term stability	10 years at $T_A = 55^\circ\text{C}$ , $I_N = \text{GND1}$		0 <sup>(7)</sup>		$\text{mV}/^\circ\text{C}$
$R_{IN}$	Input resistance		1	1.25	1.5	M $\Omega$
$\Delta R_{IN}$	Input resistance long-term stability	10 years at $T_A = 55^\circ\text{C}$		0 <sup>(7)</sup>		ppm
$TCR_{IN}$	Input resistance thermal drift	$-40^\circ\text{C} \leq T_A \leq 85^\circ\text{C}$		5		$\text{ppm}/^\circ\text{C}$
$C_{IN}$	Input capacitance	$f_{IN} = 275\text{ kHz}$		4		pF
<b>ANALOG OUTPUT</b>						
	Nominal gain			0.40		V/V
$E_G$	Gain error <sup>(1)</sup>	$T_A = 25^\circ\text{C}$	-0.2%	$\pm 0.05\%$	0.2%	
$\Delta E_G$	Gain error long-term stability	10 years at $T_A = 55^\circ\text{C}$		0 <sup>(7)</sup>		
$TCE_G$	Gain error thermal drift <sup>(1) (6)</sup>		-35	$\pm 10$	35	$\text{ppm}/^\circ\text{C}$
$\Delta TCE_G$	Gain error thermal drift long-term stability	10 years at $T_A = 55^\circ\text{C}$		0 <sup>(7)</sup>		$\text{ppm}/^\circ\text{C}$
	Nonlinearity <sup>(1)</sup>		-0.02%	$\pm 0.003\%$	0.02%	
	Nonlinearity thermal drift			0.2		$\text{ppm}/^\circ\text{C}$
THD	Total harmonic distortion <sup>(4)</sup>	$V_{IN} = 5 V_{PP}$ , $f_{IN} = 10\text{ kHz}$ , $BW = 100\text{ kHz}$		-82		dB
SNR	Signal-to-noise ratio	$V_{IN} = 5 V_{PP}$ , $f_{IN} = 1\text{ kHz}$ , $BW = 10\text{ kHz}$	75	79		dB
		$V_{IN} = 5 V_{PP}$ , $f_{IN} = 10\text{ kHz}$ , $BW = 100\text{ kHz}$		69		
	Output noise	$I_N = \text{GND1}$ , $BW = 100\text{ kHz}$		250		$\mu\text{V}_{rms}$
PSRR	Power-supply rejection ratio <sup>(2)</sup>	PSRR vs $V_{DD1}$ , DC		-67		dB
		PSRR vs $V_{DD2}$ , DC		-80		
		PSRR vs $V_{DD1}$ with 10-kHz, 100-mV ripple		-65		
		PSRR vs $V_{DD2}$ with 10-kHz, 100-mV ripple		-64		
$V_{CMout}$	Output common-mode voltage		1.39	1.44	1.49	V
$V_{CLIPout}$	Clipping differential output voltage	$V_{OUT} = (V_{OUTP} - V_{OUTN})$ , $V_{IN} > V_{Clipping}$		2.49		V
$V_{Fail-safe}$	Fail-safe differential output voltage	$V_{DD1}$ undervoltage or $V_{DD1}$ missing		-2.57	-2.5	V
BW	Output bandwidth		275	300		kHz
$R_{OUT}$	Output resistance	On $OUTP$ or $OUTN$		< 0.2		$\Omega$
	Output short-circuit current	On $OUTP$ or $OUTN$ , sourcing or sinking, $I_N = \text{GND1}$ , outputs shorted to either GND or $V_{DD2}$		14		mA
CMTI	Common-mode transient immunity		100	150		$\text{kV}/\mu\text{s}$
<b>POWER SUPPLY</b>						



## 6.9 Electrical Characteristics (continued)

minimum and maximum specifications apply from  $T_A = -40^{\circ}\text{C}$  to  $+125^{\circ}\text{C}$ ,  $V_{DD1} = 3.0\text{ V}$  to  $5.5\text{ V}$ ,  $V_{DD2} = 3.0\text{ V}$  to  $5.5\text{ V}$ ,  $I_N = -0.25\text{ V}$  to  $+5\text{ V}$  (unless otherwise noted); typical specifications are at  $T_A = 25^{\circ}\text{C}$ ,  $V_{DD1} = 5\text{ V}$ , and  $V_{DD2} = 3.3\text{ V}$

PARAMETER		TEST CONDITIONS	MIN	TYP	MAX	UNIT
VDD1 <sub>UV</sub>	VDD1 undervoltage detection threshold	VDD1 rising	2.5	2.7	2.9	V
		VDD1 falling	2.4	2.6	2.8	
VDD2 <sub>UV</sub>	VDD2 undervoltage detection threshold	VDD2 rising	2.2	2.45	2.65	V
		VDD2 falling	1.85	2.0	2.2	
I <sub>DD1</sub>	High-side supply current	3.0 V < VDD1 < 3.6 V		6.0	8.1	mA
		4.5 V < VDD1 < 5.5 V		7.0	9.3	
I <sub>DD2</sub>	Low-side supply current	3.0 V < VDD2 < 3.6 V		5.3	7.2	mA
		4.5 V < VDD2 < 5.5 V		5.9	8.1	

- (1) The typical value includes one standard deviation (*sigma*) at nominal operating conditions.
- (2) This parameter is input referred.
- (3) The typical value is at  $V_{DD1} = 3.3\text{ V}$ .
- (4) THD is the ratio of the rms sum of the amplitudes of first five higher harmonics to the amplitude of the fundamental.
- (5) Offset error temperature drift is calculated using the box method, as described by the following equation:  

$$TCV_{OS} = (V_{OS,MAX} - V_{OS,MIN}) / TempRange$$
 where  $V_{OS,MAX}$  and  $V_{OS,MIN}$  refer to the maximum and minimum  $V_{OS}$  values measured within the temperature range ( $-40$  to  $125^{\circ}\text{C}$ ).
- (6) Gain error temperature drift is calculated using the box method, as described by the following equation:  

$$TCE_G (ppm) = ((E_{G,MAX} - E_{G,MIN}) / TempRange) \times 10^4$$
 where  $E_{G,MAX}$  and  $E_{G,MIN}$  refer to the maximum and minimum  $E_G$  values (in %) measured within the temperature range ( $-40$  to  $125^{\circ}\text{C}$ ).
- (7) Value is below measurement capability.

## 6.10 Switching Characteristics

over operating ambient temperature range (unless otherwise noted)

PARAMETER		TEST CONDITIONS	MIN	TYP	MAX	UNIT
$t_r$	Output signal rise time			1.3		$\mu\text{s}$
$t_f$	Output signal fall time			1.3		$\mu\text{s}$
	IN to OUTx signal delay (50% – 10%)	Unfiltered output		1	1.5	$\mu\text{s}$
	IN to OUTx signal delay (50% – 50%)	Unfiltered output		1.6	2.1	$\mu\text{s}$
	IN to OUTx signal delay (50% – 90%)	Unfiltered output		2.5	3	$\mu\text{s}$
$t_{AS}$	Analog settling time	VDD1 step to 3.0 V with VDD2 $\geq$ 3.0 V, to $V_{OUTP}$ and $V_{OUTN}$ valid, 0.1% settling		500	800	$\mu\text{s}$

## 6.11 Timing Diagram

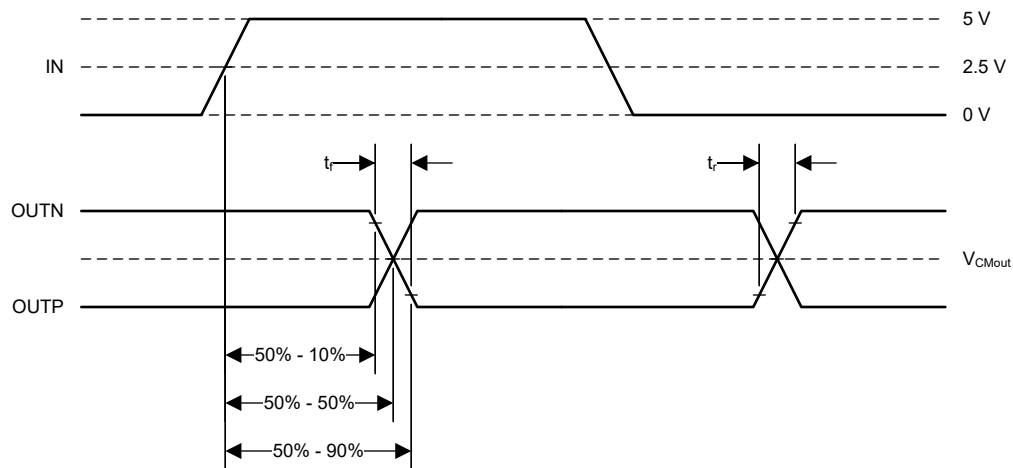
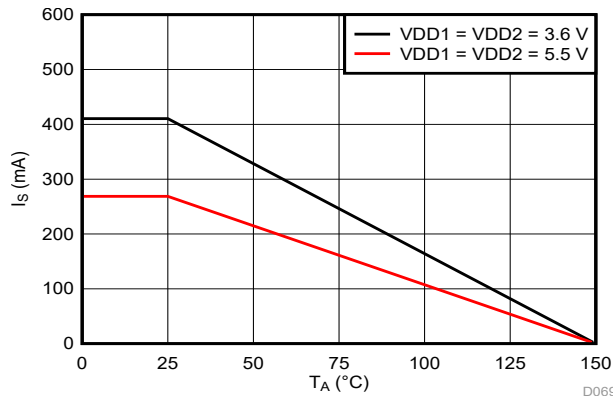
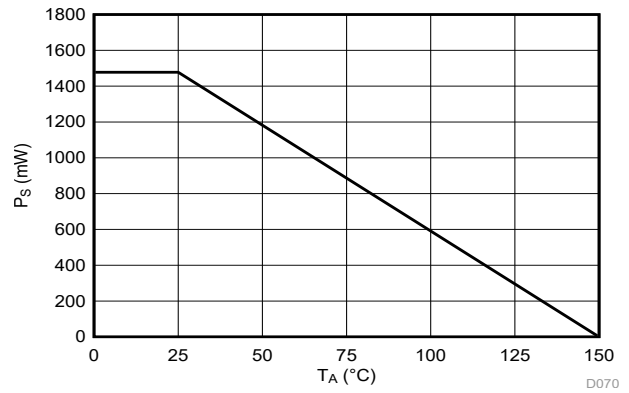

Figure 6-1. Rise, Fall, and Delay Time Definition

### 6.12 Insulation Characteristics Curves



**Figure 6-2. Thermal Derating Curve for Safety-Limiting Current per VDE**



**Figure 6-3. Thermal Derating Curve for Safety-Limiting Power per VDE**

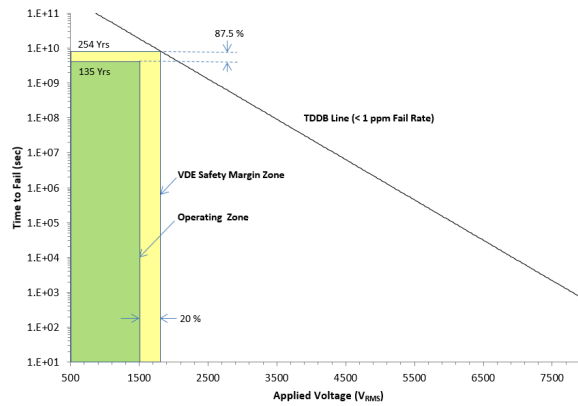

$T_A$  up to 150°C, stress-voltage frequency = 60 Hz, isolation working voltage = 1500  $V_{RMS}$ , operating lifetime = 135 years

**Figure 6-4. Reinforced Isolation Capacitor Lifetime Projection**

## 6.13 Typical Characteristics

at VDD1 = 5 V, VDD2 = 3.3 V, IN = 0 V to 5 V, and  $f_{IN} = 10$  kHz (unless otherwise noted)

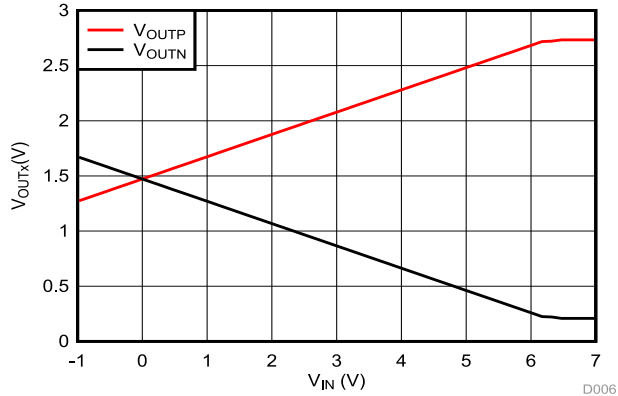
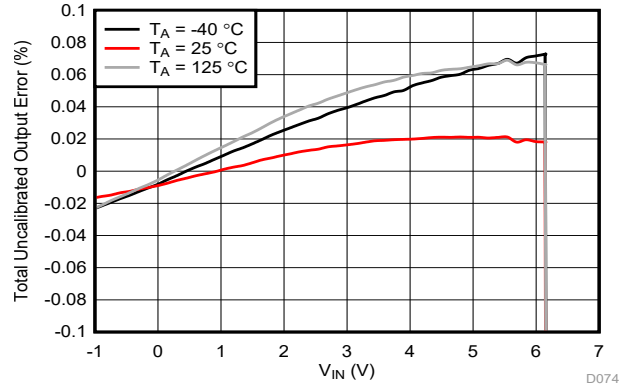

Figure 6-5. Output Voltage vs Input Voltage



Total uncalibrated output error is defined as:  
 $(V_{OUT} - V_{IN} \times G) / (V_{Clipping} \times G)$ , where G is the nominal gain of the device (0.4 V/V) and  $V_{Clipping}$  is 6.25 V

Figure 6-6. Total Uncalibrated Output Error vs Input Voltage

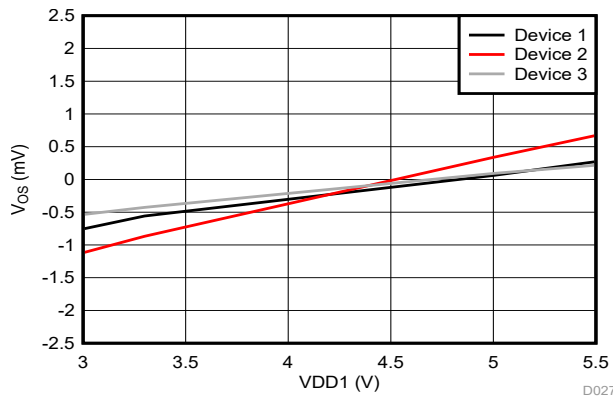

Figure 6-7. Input Offset Voltage vs High-Side Supply Voltage

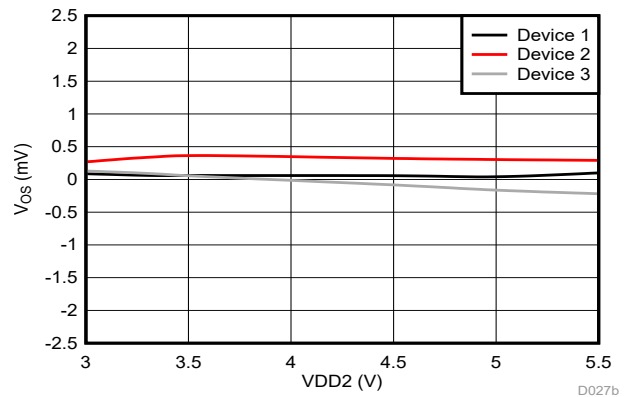

Figure 6-8. Input Offset Voltage vs Low-Side Supply Voltage

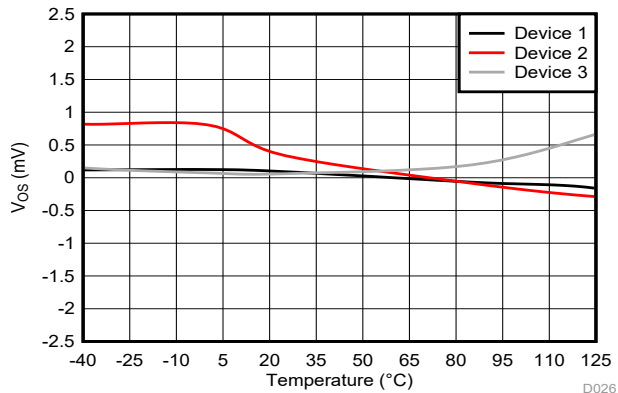

Figure 6-9. Input Offset Voltage vs Temperature

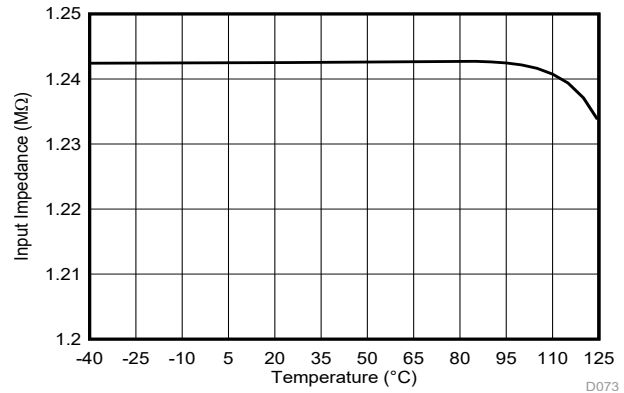
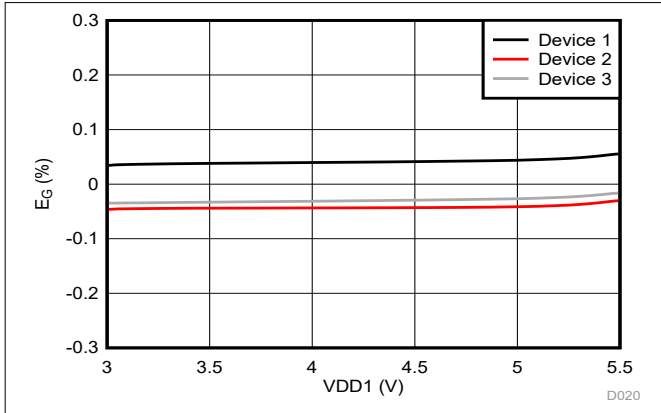

Figure 6-10. Input Impedance vs Temperature

### 6.13 Typical Characteristics (continued)

at VDD1 = 5 V, VDD2 = 3.3 V, IN = 0 V to 5 V, and  $f_{IN} = 10$  kHz (unless otherwise noted)



**Figure 6-11. Gain Error vs High-Side Supply Voltage**

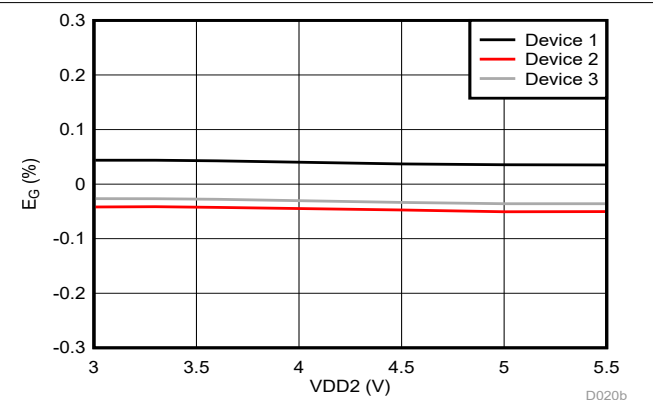

**Figure 6-12. Gain Error vs Low-Side Supply Voltage**

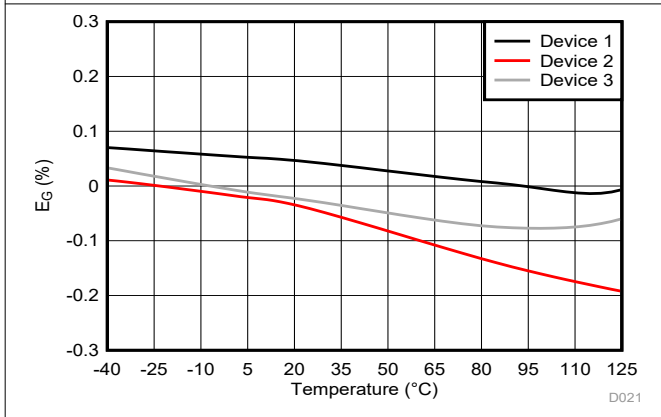

**Figure 6-13. Gain Error vs Temperature**

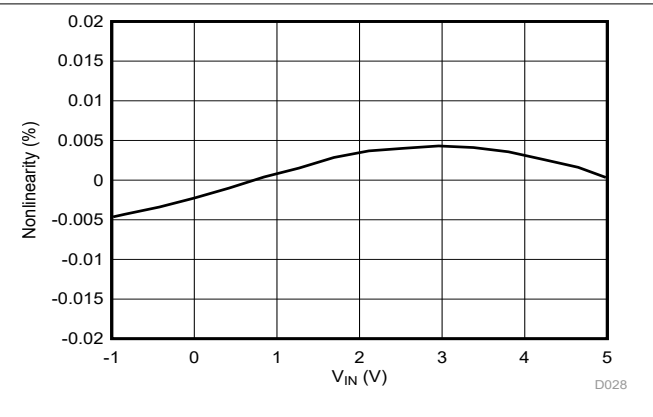

**Figure 6-14. Nonlinearity vs Input Voltage**

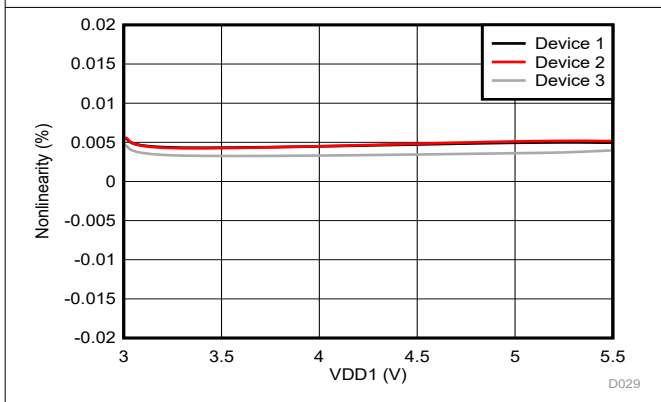

**Figure 6-15. Nonlinearity vs High-Side Supply Voltage**

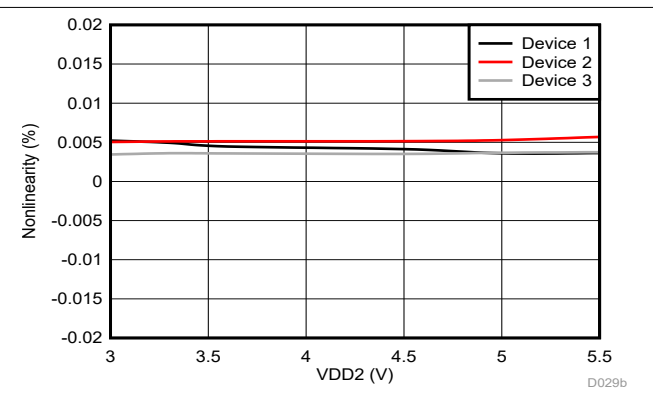

**Figure 6-16. Nonlinearity vs Low-Side Supply Voltage**

### 6.13 Typical Characteristics (continued)

at VDD1 = 5 V, VDD2 = 3.3 V, IN = 0 V to 5 V, and  $f_{IN} = 10$  kHz (unless otherwise noted)

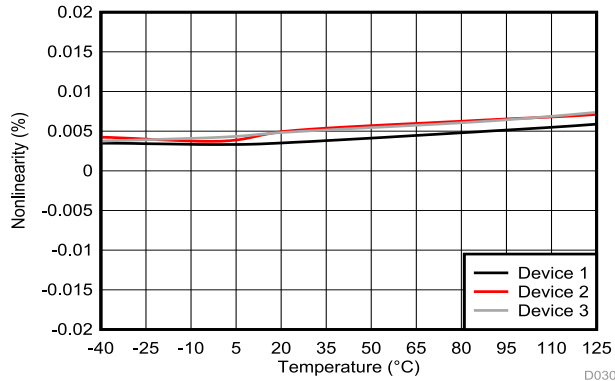

Figure 6-17. Nonlinearity vs Temperature

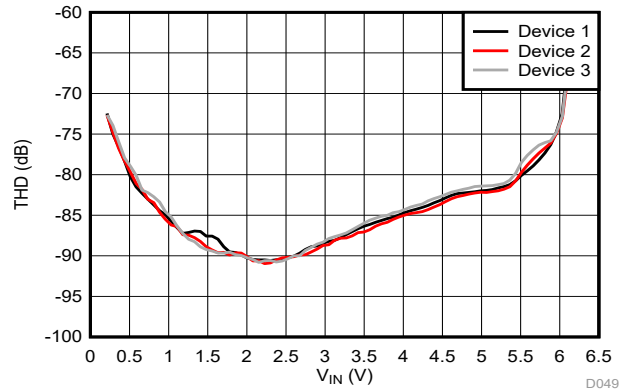

Figure 6-18. Total Harmonic Distortion vs Input Voltage

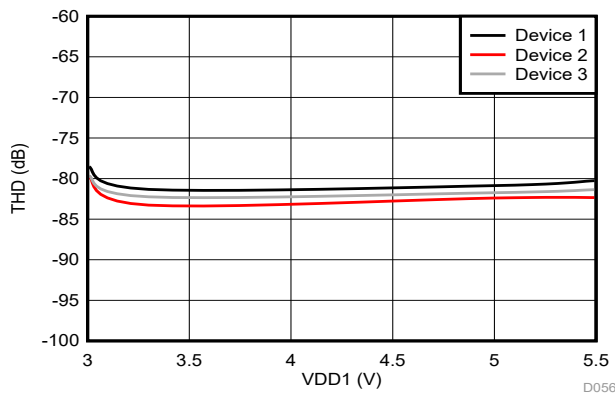

Figure 6-19. Total Harmonic Distortion vs High-Side Supply Voltage

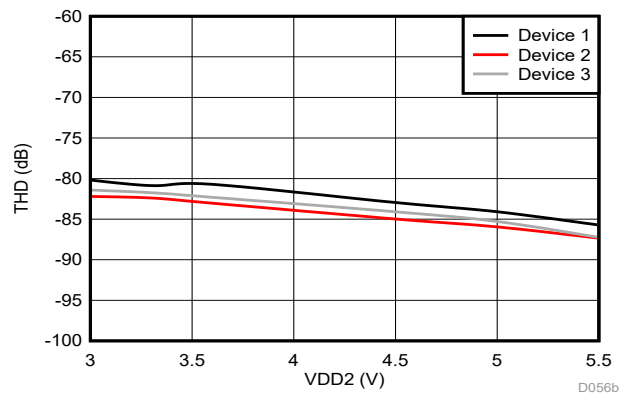

Figure 6-20. Total Harmonic Distortion vs Low-Side Supply Voltage

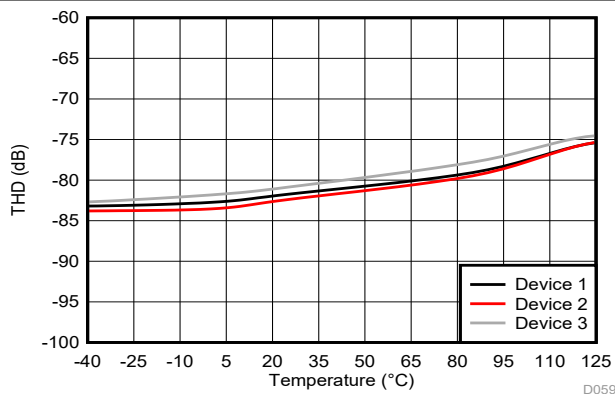

Figure 6-21. Total Harmonic Distortion vs Temperature

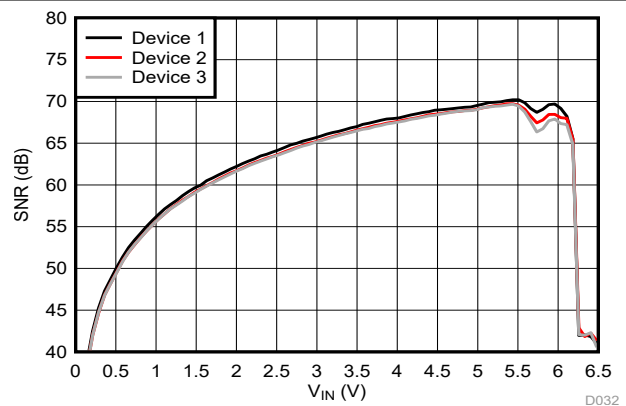

Figure 6-22. Signal-to-Noise Ratio vs Input Voltage

### 6.13 Typical Characteristics (continued)

at VDD1 = 5 V, VDD2 = 3.3 V, IN = 0 V to 5 V, and  $f_{IN} = 10$  kHz (unless otherwise noted)

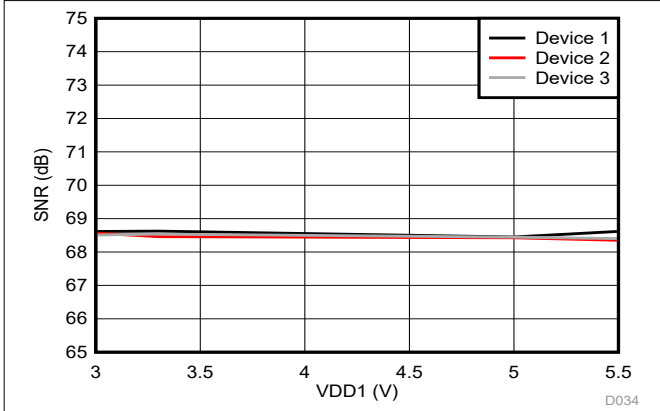

Figure 6-23. Signal-to-Noise Ratio vs High-Side Supply Voltage

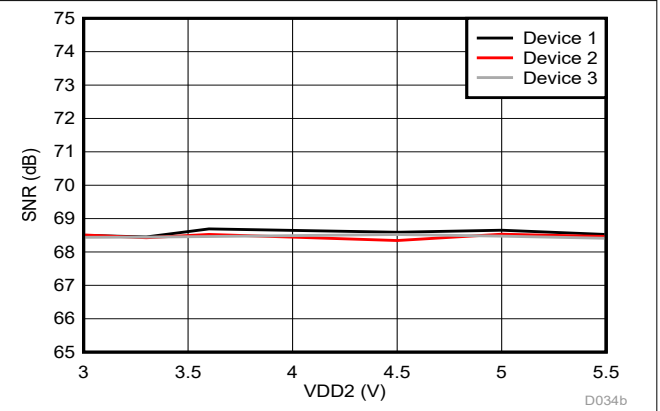

Figure 6-24. Signal-to-Noise Ratio vs Low-Side Supply Voltage

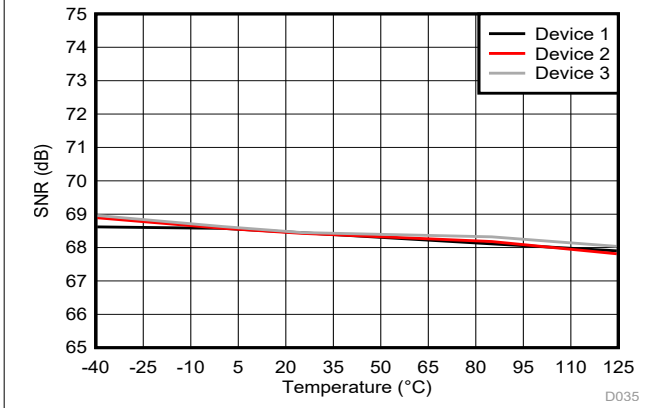

Figure 6-25. Signal-to-Noise Ratio vs Temperature

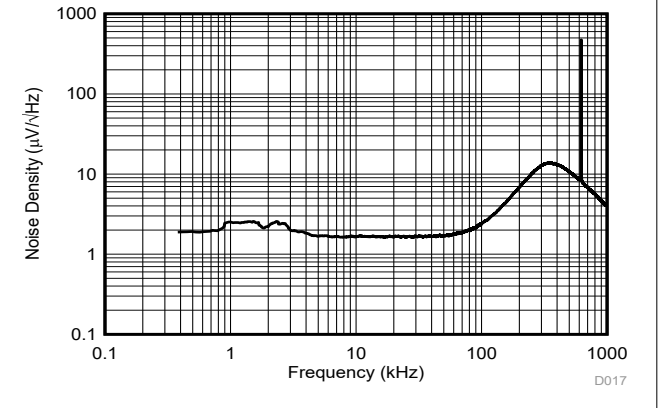

Figure 6-26. Input-Referred Noise Density vs Frequency

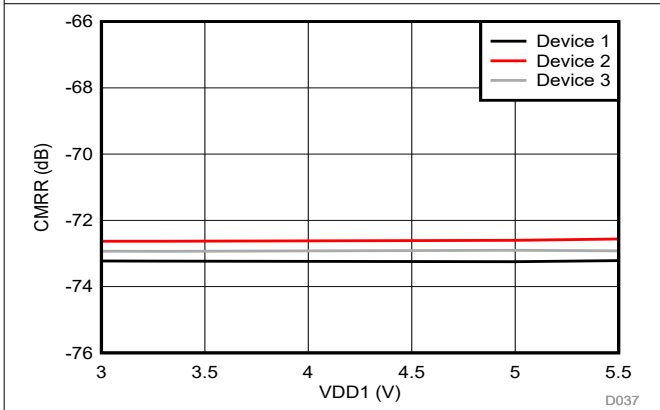

Figure 6-27. Common-Mode Rejection Ratio vs Supply Voltage

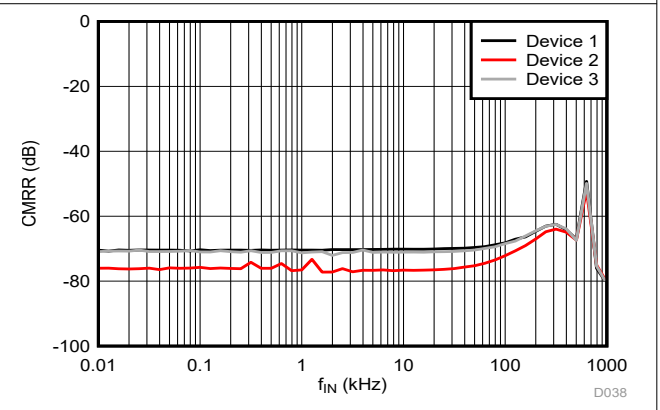

Figure 6-28. Common-Mode Rejection Ratio vs Input Frequency

### 6.13 Typical Characteristics (continued)

at VDD1 = 5 V, VDD2 = 3.3 V, IN = 0 V to 5 V, and  $f_{IN} = 10$  kHz (unless otherwise noted)

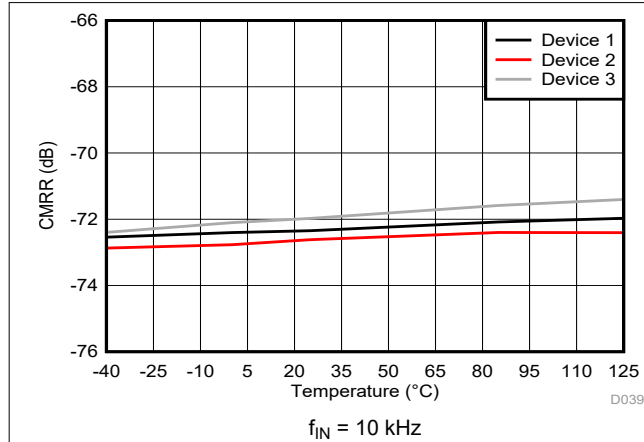

Figure 6-29. Common-Mode Rejection Ratio vs Temperature

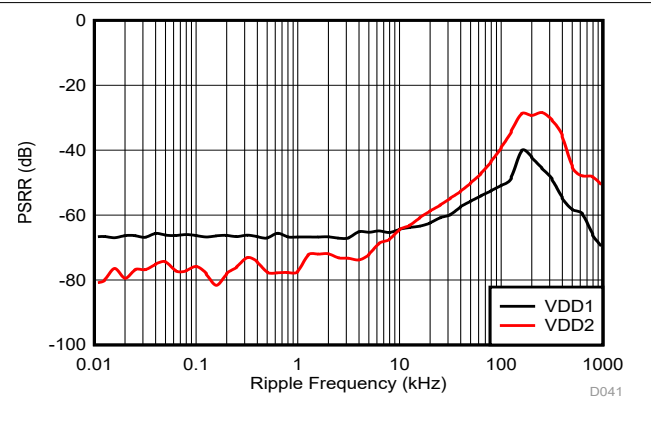

Figure 6-30. Power-Supply Rejection Ratio vs Ripple Frequency

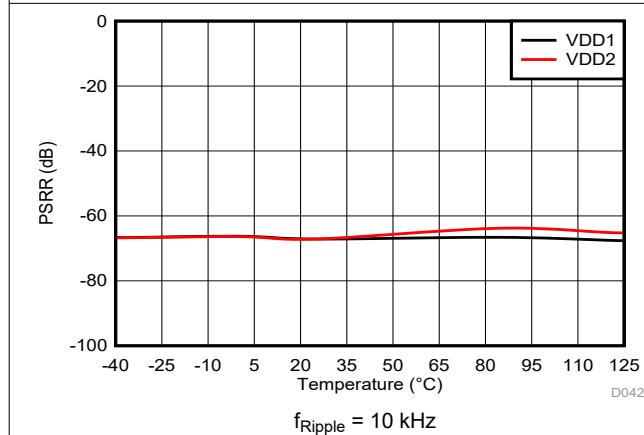

Figure 6-31. Power-Supply Rejection Ratio vs Temperature

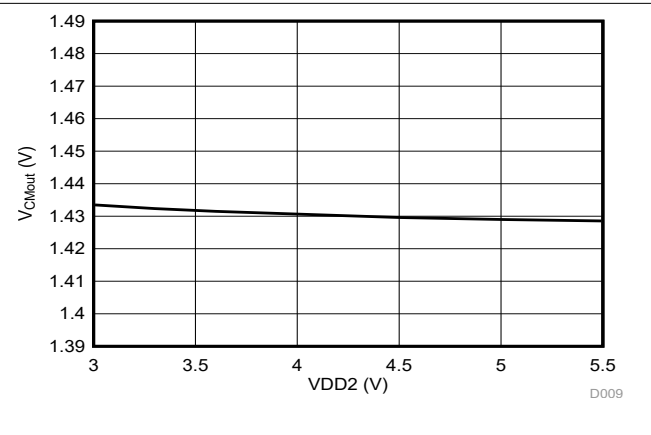

Figure 6-32. Common-Mode Output Voltage vs Supply Voltage

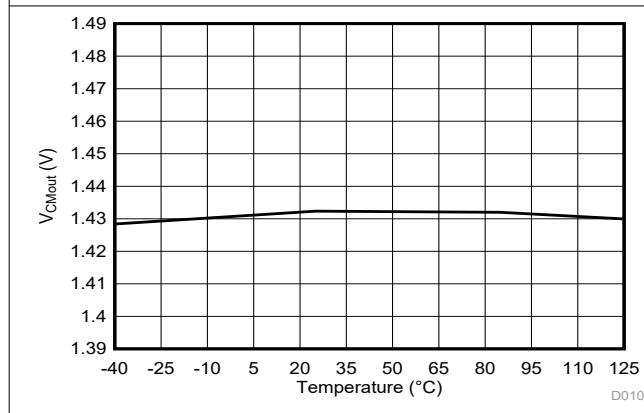

Figure 6-33. Common-Mode Output Voltage vs Temperature

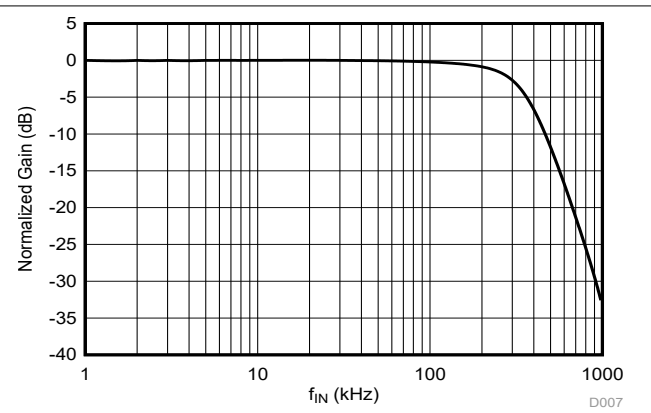

Figure 6-34. Normalized Gain vs Input Frequency



### 6.13 Typical Characteristics (continued)

at VDD1 = 5 V, VDD2 = 3.3 V, IN = 0 V to 5 V, and  $f_{IN} = 10$  kHz (unless otherwise noted)

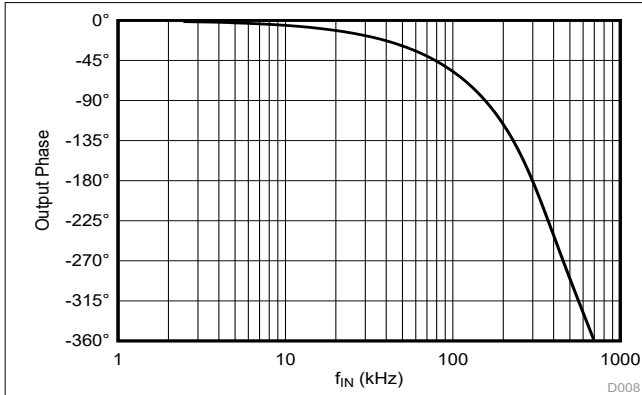

Figure 6-35. Output Phase vs Input Frequency

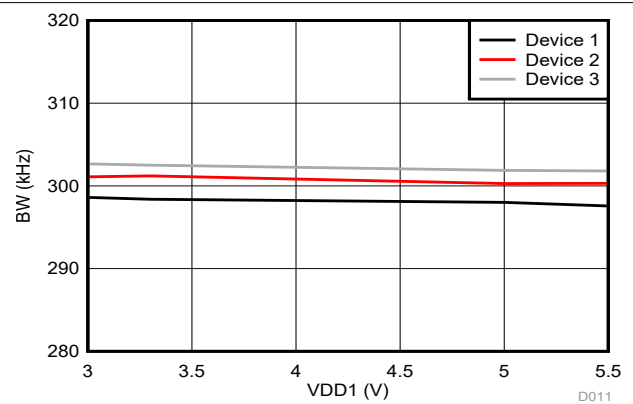

Figure 6-36. Bandwidth vs Supply Voltage

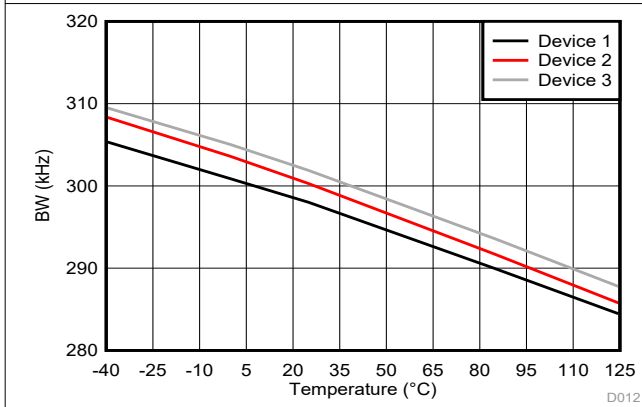

Figure 6-37. Bandwidth vs Temperature

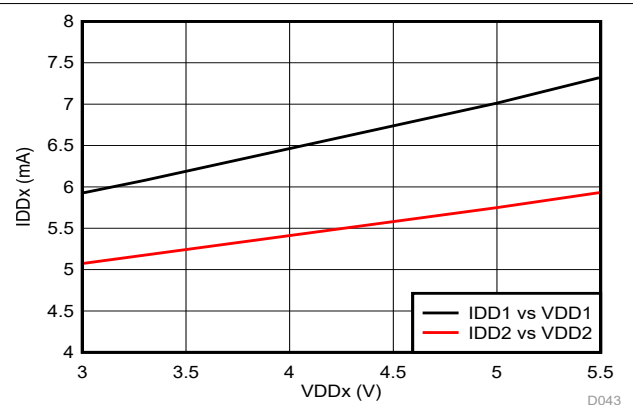

Figure 6-38. Supply Current vs Supply Voltage

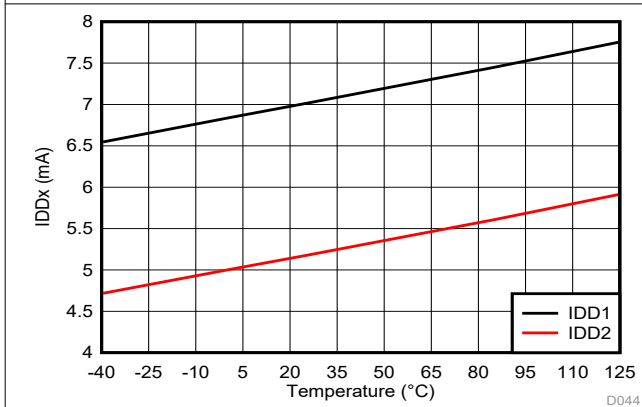

Figure 6-39. Supply Current vs Temperature

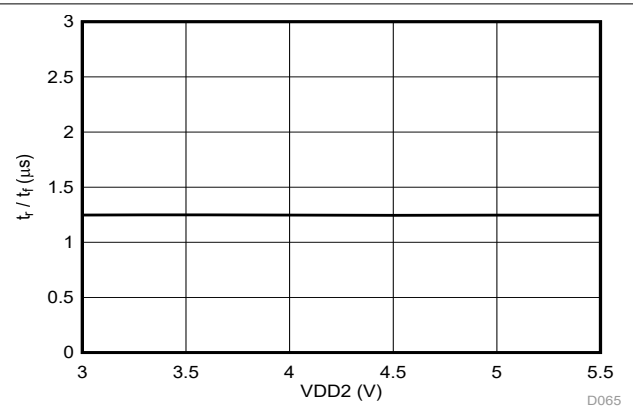
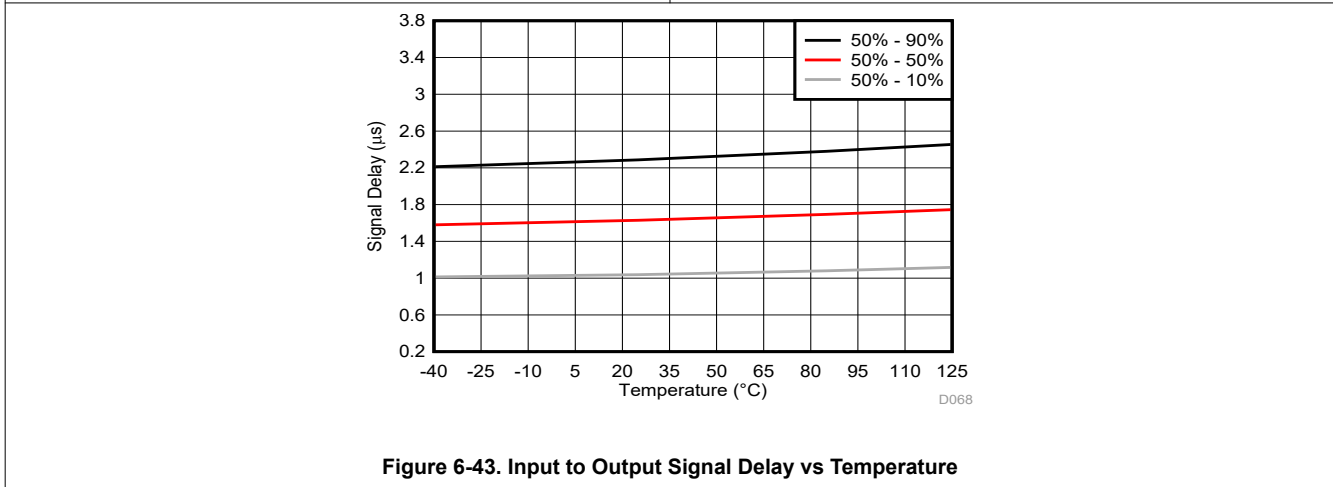
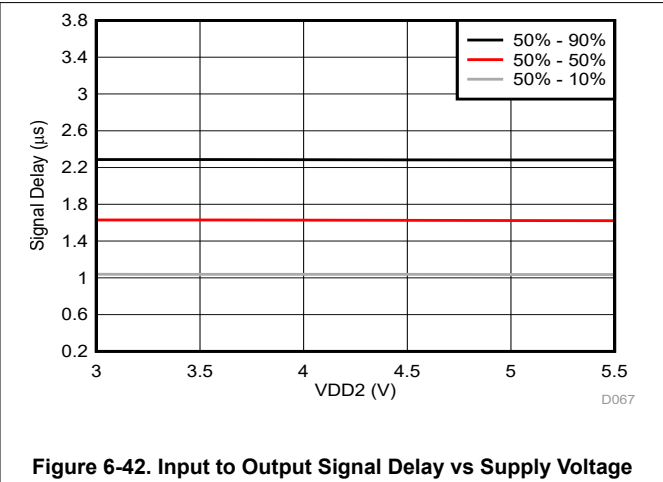
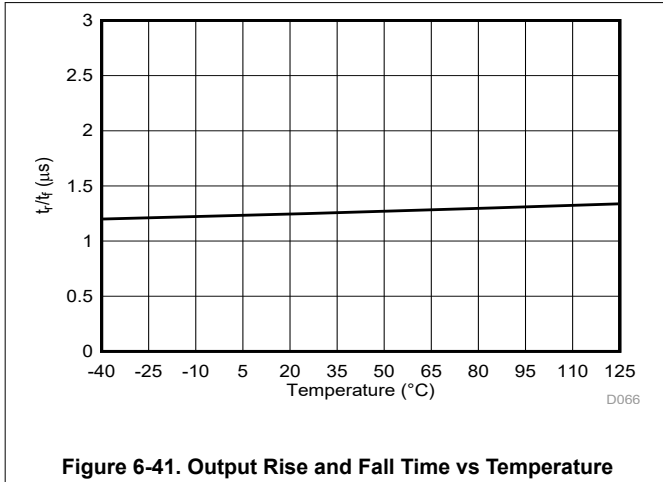

Figure 6-40. Output Rise and Fall Time vs Supply Voltage

### 6.13 Typical Characteristics (continued)

at VDD1 = 5 V, VDD2 = 3.3 V, IN = 0 V to 5 V, and  $f_{IN} = 10$  kHz (unless otherwise noted)



## 7 Detailed Description

### 7.1 Overview

The AMC1351-Q1 is a single-ended input, precision, isolated amplifier with a high input-impedance and wide input-voltage range. The input stage of the device drives a second-order, delta-sigma ( $\Delta\Sigma$ ) modulator. The modulator converts the analog input signal into a digital bitstream that is transferred across the isolation barrier that separates the high-side from the low-side. On the low-side, the received bitstream is processed by a fourth-order analog filter that outputs a differential signal at the OUTP and OUTN pins proportional to the input signal.

The SiO<sub>2</sub>-based, capacitive isolation barrier supports a high level of magnetic field immunity, as described in the [ISO72x Digital Isolator Magnetic-Field Immunity application report](#). The digital modulation used in the AMC1351-Q1 to transmit data across the isolation barrier, and the isolation barrier characteristics itself, result in high reliability and common-mode transient immunity.

### 7.2 Functional Block Diagram

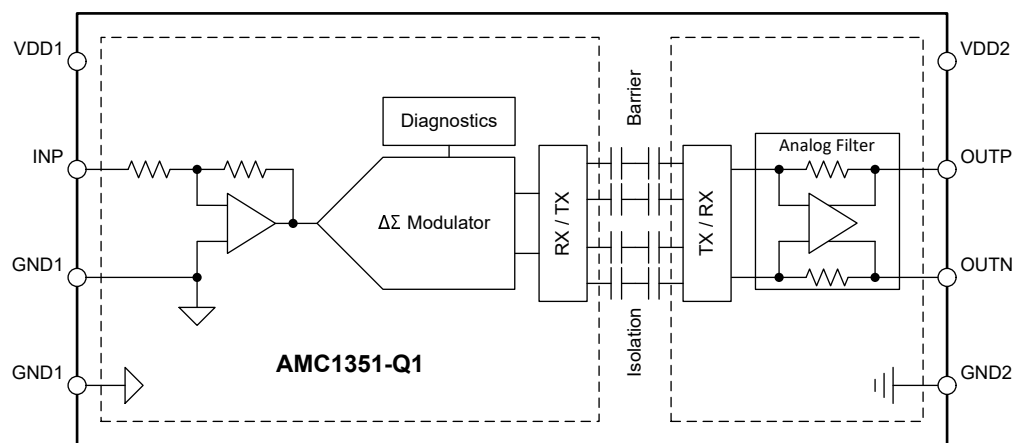

### 7.3 Feature Description

#### 7.3.1 Analog Input

The single-ended, high-impedance input stage of the AMC1351-Q1 feeds a second-order, switched-capacitor, feed-forward  $\Delta\Sigma$  modulator. The modulator converts the analog signal into a bitstream that is transferred across the isolation barrier, as described in the [Isolation Channel Signal Transmission](#) section.

There are two restrictions on the analog input signal IN. First, if the input voltage  $V_{IN}$  exceeds the range specified in the [Absolute Maximum Ratings](#) table, the input current must be limited to the absolute maximum value because the electrostatic discharge (ESD) protection turns on. In addition, the linearity and parametric performance of the device is ensured only when the analog input voltage remains within the linear full-scale range ( $V_{FSR}$ ) as specified in the [Recommended Operating Conditions](#) table.

### 7.3.2 Isolation Channel Signal Transmission

The AMC1351-Q1 uses an on-off keying (OOK) modulation scheme, as shown in Figure 7-1, to transmit the modulator output bitstream across the SiO<sub>2</sub>-based isolation barrier. The transmit driver (TX) shown in the *Functional Block Diagram* transmits an internally-generated, high-frequency carrier across the isolation barrier to represent a digital one and does not send a signal to represent a digital zero. The nominal frequency of the carrier used inside the AMC1351-Q1 is 480 MHz.

The receiver (RX) on the other side of the isolation barrier recovers and demodulates the signal and provides the input to the fourth-order analog filter. The AMC1351-Q1 transmission channel is optimized to achieve the highest level of common-mode transient immunity (CMTI) and lowest level of radiated emissions caused by the high-frequency carrier and RX, TX buffer switching.

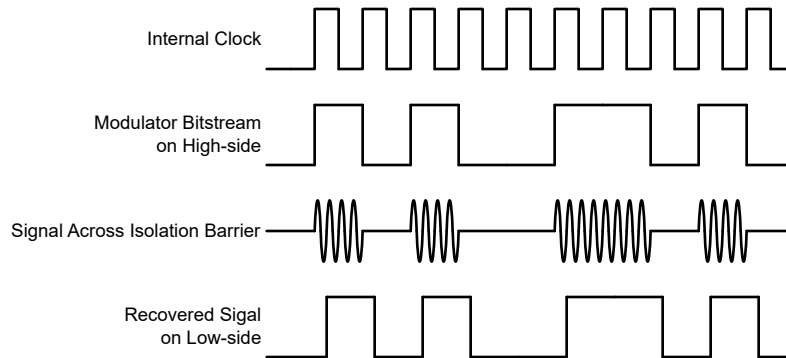

**Figure 7-1. OOK-Based Modulation Scheme**

### 7.3.3 Analog Output

The AMC1351-Q1 provides a differential analog output on the OUTP and OUTN pins. For input voltages ( $V_{IN}$ ) in the range from  $-0.25\text{ V}$  to  $5\text{ V}$ , the device provides a linear response with a nominal gain of  $0.4\text{ V/V}$ . For example, for an input voltage of  $5\text{ V}$ , the differential output voltage ( $V_{OUTP} - V_{OUTN}$ ) is  $2\text{ V}$ . At zero input (IN shorted to GND1), both pins output the same common-mode output voltage  $V_{CMout}$ , as specified in the [Electrical Characteristics](#) table. For input voltages greater than  $5\text{ V}$  but less than approximately  $6.25\text{ V}$ , the differential output voltage continues to increase but with reduced linearity performance. The outputs saturate at a differential output voltage of  $V_{CLIPout}$ , as shown in [Figure 7-2](#), if the input voltage exceeds the  $V_{Clipping}$  value.

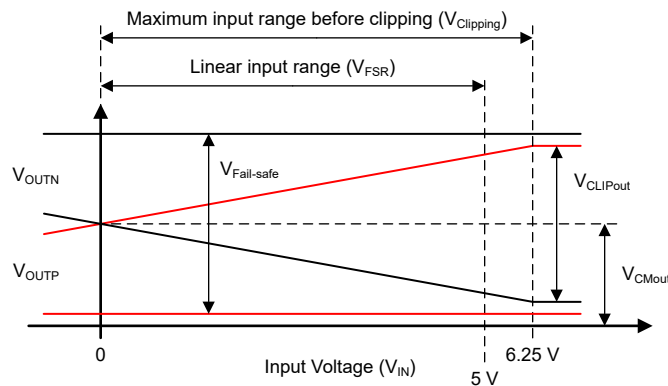

**Figure 7-2. Output Behavior of the AMC1351-Q1**

The AMC1351-Q1 output offers a fail-safe feature that simplifies diagnostics on a system level. [Figure 7-2](#) shows the behavior in fail-safe mode, in which the AMC1351-Q1 outputs a negative differential output voltage that does not occur under normal operating conditions. The fail-safe output is active:

- When the high-side supply VDD1 of the AMC1351-Q1 device is missing
- When the high-side supply VDD1 falls below the undervoltage threshold  $VDD1_{UV}$

Use the maximum  $V_{Fail-safe}$  voltage specified in the [Electrical Characteristics](#) table as a reference value for fail-safe detection on a system level.

### 7.4 Device Functional Modes

The AMC1351-Q1 is operational when the power supplies VDD1 and VDD2 are applied as specified in the [Recommended Operating Conditions](#) table.

## 8 Application and Implementation

### Note

Information in the following applications sections is not part of the TI component specification, and TI does not warrant its accuracy or completeness. TI's customers are responsible for determining suitability of components for their purposes, as well as validating and testing their design implementation to confirm system functionality.

### 8.1 Application Information

The high input impedance, low input bias current, excellent accuracy, and low temperature drift make the AMC1351-Q1 a high-performance solution for automotive applications where voltage sensing in the presence of high common-mode voltage levels is required.

### 8.2 Typical Application

Isolated amplifiers are widely used for voltage measurements in high-voltage applications that must be isolated from a low-voltage domain. A typical application is the sensing of the DC bus voltage in a frequency inverter.

With its wide, 5-V input voltage range, the AMC1351-Q1 is designed for isolated DC voltage-sensing applications where accurate voltage monitoring is required in high-noise environments.

Figure 8-1 shows a simplified schematic of the AMC1351-Q1 in a typical motor drive application. The DC bus voltage is divided down to an approximate 5-V level across the bottom resistor (RSNS) of a high-impedance resistor divider that is sensed by the AMC1351-Q1. The AMC1351-Q1 digitizes the analog input signal on the high-side, transfers the data across the isolation barrier to the low-side, and reconstructs an analog signal that is presented as a differential voltage on the output pins.

The high-impedance input and the high common-mode transient immunity (CMTI) of the AMC1351-Q1 ensure reliable and accurate operation even in high-noise environments.

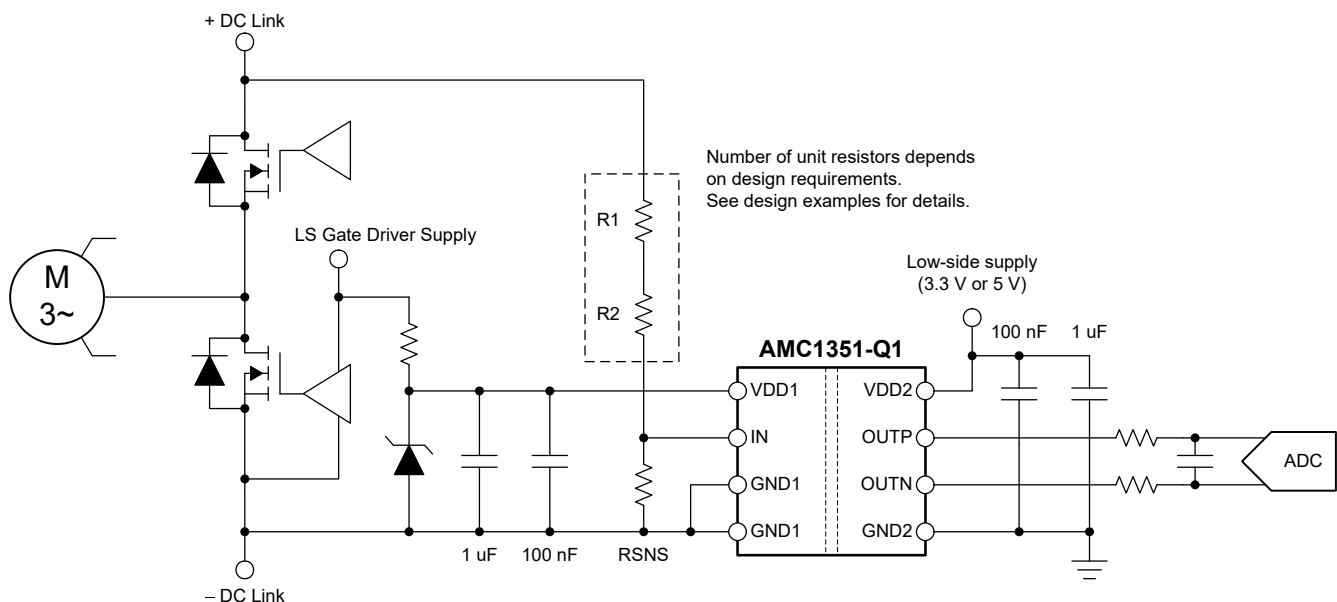

**Figure 8-1. Using the AMC1351-Q1 for DC Link Voltage Sensing in Frequency Inverters**

## 8.2.1 Design Requirements

Table 8-1 lists the parameters for this typical application.

**Table 8-1. Design Requirements**

PARAMETER	190-V <sub>DC</sub> LINE VOLTAGE	360-V <sub>DC</sub> LINE VOLTAGE
System input voltage	120 V <sub>RMS</sub> ±10%, 60 Hz	230 V <sub>RMS</sub> ±10%, 50 Hz
DC bus voltage (max)	190 V	360 V
High-side supply voltage	3.3 V or 5 V	3.3 V or 5 V
Low-side supply voltage	3.3 V or 5 V	3.3 V or 5 V
Maximum resistor operating voltage	75 V	75 V
Voltage drop across the sense resistor (RSNS) for a linear response	5 V (maximum)	5 V (maximum)
Current through the resistive divider (I <sub>CROSS</sub> )	100 μA	100 μA

## 8.2.2 Detailed Design Procedure

This discussion covers the 360-V<sub>DC</sub> example. The procedure for calculating the resistive divider for the 190-V<sub>DC</sub> use case is identical.

The 100-μA, cross-current requirement at peak input voltage (360 V) determines that the total impedance of the resistive divider is 3.6 MΩ. The impedance of the resistive divider is dominated by the top resistors (shown exemplarily as R1 and R2 in Figure 8-1) and the voltage drop across RSNS can be neglected for a short time. The maximum allowed voltage drop per unit resistor is specified as 75 V; therefore, the total minimum number of unit resistors in the top portion of the resistive divider is 360 V / 75 V = 5. The calculated unit value is 3.6 MΩ / 5 = 720 kΩ and the next closest value from the E96 series is 715 kΩ.

The *effective* sense resistor value RSNS<sub>EFF</sub> is the parallel combination of the external resistor RSNS and the input impedance of the AMC1351-Q1, R<sub>IN</sub>. RSNS<sub>EFF</sub> is sized such that the voltage drop across the impedance at maximum input voltage (360 V) equals the linear full-scale input voltage (V<sub>FSR</sub>) of the AMC1351-Q1 (that is, 5 V). RSNS<sub>EFF</sub> is calculated as  $RSNS_{EFF} = V_{FSR} / (V_{Peak} - V_{FSR}) \times R_{TOP}$ , where R<sub>TOP</sub> is the total value of top resistor string (5 × 715 kΩ = 3575 kΩ). The resulting value for RSNS<sub>EFF</sub> is 9.96 kΩ. In a final step, RSNS is calculated as  $RSNS = R_{IN} \times RSNS_{EFF} / (R_{IN} - RSNS_{EFF})$ . With R<sub>IN</sub> = 1.25 MΩ (typical), RSNS equals 52.47 kΩ and the next closest value from the E96 series is 52.3 kΩ.

Table 8-2 summarizes the design of the resistive divider.

**Table 8-2. Resistor Value Examples**

PARAMETER	190-V <sub>DC</sub> LINE VOLTAGE	360-V <sub>DC</sub> LINE VOLTAGE
Unit resistor value (R <sub>TOP</sub> )	634 kΩ	715 kΩ
Number of unit resistors in R <sub>TOP</sub>	3	5
Sense resistor value (RSNS)	51.1 kΩ	49.9 kΩ
Total resistance value (R <sub>TOP</sub> + RSNS)	1953.1 kΩ	3624.9 kΩ
Resulting current through resistive divider (I <sub>CROSS</sub> )	97.3 μA	99.3 μA
Resulting full-scale voltage drop across sense resistor RSNS	4.971 V	4.956 V
Peak power dissipated in R <sub>TOP</sub> unit resistors	6 mW	7.1 mW
Total peak power dissipated in resistive divider	18.5 mW	35.8 mW

### 8.2.2.1 Input Filter Design

Placing an RC filter in front of the isolated amplifier improves signal-to-noise performance of the signal path. In practice, however, the impedance of the resistor divider is so high that adding a filter capacitor on the IN pin limits the signal bandwidth to an unacceptable low limit, such that the filter capacitor is omitted. When used, design the input filter such that:

- The cutoff frequency of the filter is at least one order of magnitude lower than the sampling frequency (20 MHz) of the internal  $\Delta\Sigma$  modulator
- The input bias current does not generate significant voltage drop across the DC impedance of the input filter

Most voltage-sensing applications use high-impedance resistor dividers in front of the isolated amplifier to scale down the input voltage. In that case, no additional resistor is needed and a single capacitor (as shown in [Figure 8-2](#)) is sufficient to filter the input signal.

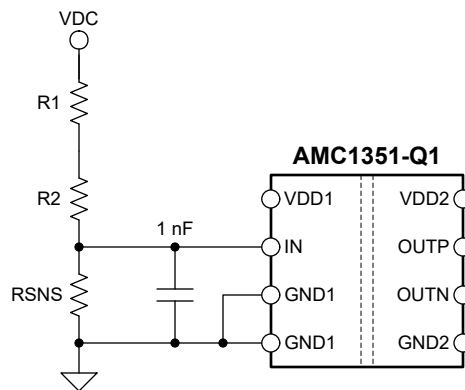

Figure 8-2. Input Filter

### 8.2.2.2 Differential to Single-Ended Output Conversion

[Figure 8-3](#) shows an example of a [TLVx313-Q1](#)-based signal conversion and filter circuit for systems using single-ended input ADCs to convert the analog output voltage into digital. With  $R1 = R2 = R3 = R4$ , the output voltage equals  $(V_{OUTP} - V_{OUTN}) + V_{REF}$ . Tailor the bandwidth of this filter stage to the bandwidth requirement of the system and use NP0-type capacitors for best performance. For most applications,  $R1 = R2 = R3 = R4 = 3.3\text{ k}\Omega$  and  $C1 = C2 = 330\text{ pF}$  yields good performance.

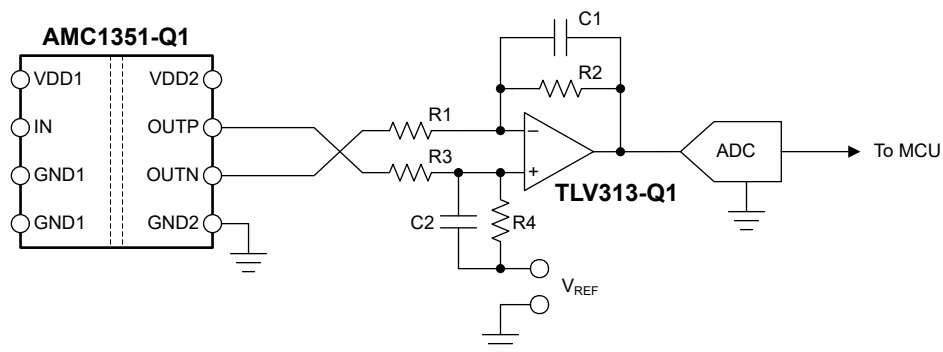

Figure 8-3. Connecting the AMC1351-Q1 Output to a Single-Ended Input ADC

For more information on the general procedure to design the filtering and driving stages of SAR ADCs, see the [18-Bit, 1MSPS Data Acquisition Block \(DAQ\) Optimized for Lowest Distortion and Noise](#) and [18-Bit Data Acquisition Block \(DAQ\) Optimized for Lowest Power reference guides](#), available for download at [www.ti.com](http://www.ti.com).



### 8.2.3 Application Curve

One important aspect of system design is the effective detection of an overvoltage condition to protect switching devices and passive components from damage. To power off the system quickly in the event of an overvoltage condition, a low delay caused by the isolated amplifier is required. Figure 8-4 shows the typical full-scale step response of the AMC1351-Q1.

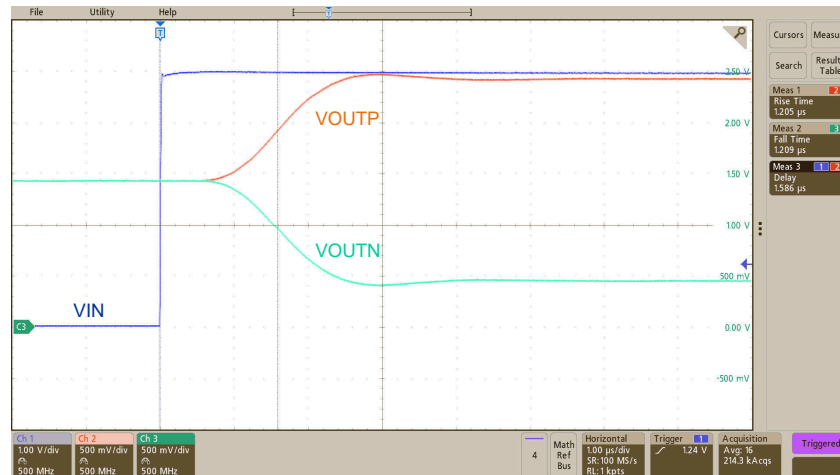

**Figure 8-4. Step Response of the AMC1351-Q1**

### 8.3 What To Do and What Not To Do

Do not leave the analog input (IN) of the AMC1351-Q1 unconnected (floating) when the device is powered up on the high-side. If the device input is left floating, the bias current may generate a positive or negative input voltage and the output of the device is undetermined.

Do not connect protection diodes to the input (IN) of the AMC1351-Q1. Diode leakage current can introduce significant measurement error especially at high temperatures. The input pin is protected against high voltages by its ESD protection circuit and the high impedance of the external resistive divider

Connect both GND1 pins to the high-side ground potential. Do not leave one of the GND1 pins unconnected.

## 9 Power Supply Recommendations

In a typical application, the high-side power supply (VDD1) for the AMC1351-Q1 is generated either from a gate-driver supply on the high-side (as shown in [Figure 8-1](#)), or from the low-side supply (VDD2) by an isolated DC/DC converter. A low-cost solution is based on the push-pull driver [SN6501](#) and a transformer that supports the desired isolation voltage ratings.

The AMC1351-Q1 does not require any specific power-up sequencing. The high-side power supply (VDD1) is decoupled with a low-ESR, 100-nF capacitor (C1) parallel to a low-ESR, 1- $\mu$ F capacitor (C2). The low-side power supply (VDD2) is equally decoupled with a low-ESR, 100-nF capacitor (C3) parallel to a low-ESR, 1- $\mu$ F capacitor (C4). Place all four capacitors (C1, C2, C3, and C4) as close to the device as possible.

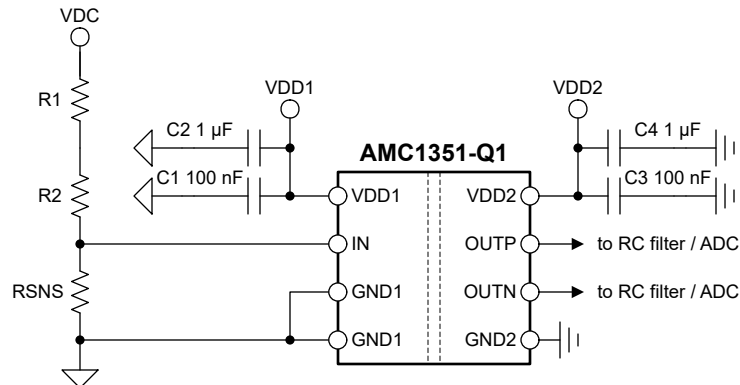

**Figure 9-1. Decoupling of the AMC1351-Q1**

Capacitors must provide adequate effective capacitance under the applicable DC bias conditions they experience in the application. Multilayer ceramic capacitors (MLCC) typically exhibit only a fraction of their nominal capacitance under real-world conditions and this factor must be taken into consideration when selecting these capacitors. This problem is especially acute in low-profile capacitors, in which the dielectric field strength is higher than in taller components. Reputable capacitor manufacturers provide capacitance versus DC bias curves that greatly simplify component selection.

## 10 Layout

### 10.1 Layout Guidelines

Figure 10-1 shows a layout recommendation with the critical placement of the decoupling capacitors (as close as possible to the AMC1351-Q1 supply pins) and placement of the other components required by the device. For best performance, place the sense resistor close to the device input pin (IN).

### 10.2 Layout Example

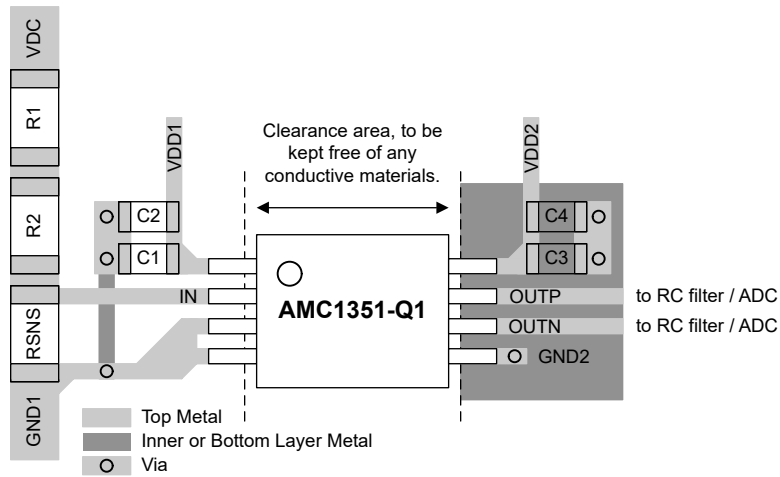

**Figure 10-1. Recommended Layout of the AMC1351-Q1**

## 11 Device and Documentation Support

### 11.1 Documentation Support

#### 11.1.1 Related Documentation

For related documentation, see the following:

- Texas Instruments, [Isolation Glossary application report](#)
- Texas Instruments, [Semiconductor and IC Package Thermal Metrics application report](#)
- Texas Instruments, [ISO72x Digital Isolator Magnetic-Field Immunity application report](#)
- Texas Instruments, [TLVx313-Q1 Low-Power, Rail-to-Rail In/Out, 750- \$\mu\$ V Typical Offset, 1-MHz Operational Amplifier for Cost-Sensitive Systems data sheet](#)
- Texas Instruments, [18-Bit, 1-MSPS Data Acquisition Block \(DAQ\) Optimized for Lowest Distortion and Noise reference guide](#)
- Texas Instruments, [18-Bit, 1-MSPS Data Acquisition Block \(DAQ\) Optimized for Lowest Power reference guide](#)
- Texas Instruments, [Isolated Amplifier Voltage Sensing Excel Calculator design tool](#)
- Texas Instruments, [Best in Class Radiated Emissions EMI Performance with the AMC1300B-Q1 Isolated Amplifier technical white paper](#)

#### 11.2 Receiving Notification of Documentation Updates

To receive notification of documentation updates, navigate to the device product folder on [ti.com](http://ti.com). Click on *Subscribe to updates* to register and receive a weekly digest of any product information that has changed. For change details, review the revision history included in any revised document.

#### 11.3 Support Resources

[TI E2E™ support forums](#) are an engineer's go-to source for fast, verified answers and design help — straight from the experts. Search existing answers or ask your own question to get the quick design help you need.

Linked content is provided "AS IS" by the respective contributors. They do not constitute TI specifications and do not necessarily reflect TI's views; see TI's [Terms of Use](#).

#### 11.4 Trademarks

TI E2E™ is a trademark of Texas Instruments.  
All trademarks are the property of their respective owners.

#### 11.5 Electrostatic Discharge Caution



This integrated circuit can be damaged by ESD. Texas Instruments recommends that all integrated circuits be handled with appropriate precautions. Failure to observe proper handling and installation procedures can cause damage.

ESD damage can range from subtle performance degradation to complete device failure. Precision integrated circuits may be more susceptible to damage because very small parametric changes could cause the device not to meet its published specifications.

#### 11.6 Glossary

[TI Glossary](#) This glossary lists and explains terms, acronyms, and definitions.

## 12 Mechanical, Packaging, and Orderable Information

The following pages include mechanical, packaging, and orderable information. This information is the most current data available for the designated devices. This data is subject to change without notice and revision of this document. For browser-based versions of this data sheet, refer to the left-hand navigation.

**PACKAGING INFORMATION**

Orderable Device	Status (1)	Package Type	Package Drawing	Pins	Package Qty	Eco Plan (2)	Lead finish/ Ball material (6)	MSL Peak Temp (3)	Op Temp (°C)	Device Marking (4/5)	Samples
AMC1351QDWVRQ1	ACTIVE	SOIC	DWV	8	1000	RoHS & Green	NIPDAU	Level-3-260C-168 HR	-40 to 125	AMC1351Q	Samples

(1) The marketing status values are defined as follows:

**ACTIVE:** Product device recommended for new designs.

**LIFEBUY:** TI has announced that the device will be discontinued, and a lifetime-buy period is in effect.

**NRND:** Not recommended for new designs. Device is in production to support existing customers, but TI does not recommend using this part in a new design.

**PREVIEW:** Device has been announced but is not in production. Samples may or may not be available.

**OBSELETE:** TI has discontinued the production of the device.

(2) **RoHS:** TI defines "RoHS" to mean semiconductor products that are compliant with the current EU RoHS requirements for all 10 RoHS substances, including the requirement that RoHS substance do not exceed 0.1% by weight in homogeneous materials. Where designed to be soldered at high temperatures, "RoHS" products are suitable for use in specified lead-free processes. TI may reference these types of products as "Pb-Free".

**RoHS Exempt:** TI defines "RoHS Exempt" to mean products that contain lead but are compliant with EU RoHS pursuant to a specific EU RoHS exemption.

**Green:** TI defines "Green" to mean the content of Chlorine (Cl) and Bromine (Br) based flame retardants meet JS709B low halogen requirements of <=1000ppm threshold. Antimony trioxide based flame retardants must also meet the <=1000ppm threshold requirement.

(3) MSL, Peak Temp. - The Moisture Sensitivity Level rating according to the JEDEC industry standard classifications, and peak solder temperature.

(4) There may be additional marking, which relates to the logo, the lot trace code information, or the environmental category on the device.

(5) Multiple Device Markings will be inside parentheses. Only one Device Marking contained in parentheses and separated by a "-" will appear on a device. If a line is indented then it is a continuation of the previous line and the two combined represent the entire Device Marking for that device.

(6) Lead finish/Ball material - Orderable Devices may have multiple material finish options. Finish options are separated by a vertical ruled line. Lead finish/Ball material values may wrap to two lines if the finish value exceeds the maximum column width.

**Important Information and Disclaimer:**The information provided on this page represents TI's knowledge and belief as of the date that it is provided. TI bases its knowledge and belief on information provided by third parties, and makes no representation or warranty as to the accuracy of such information. Efforts are underway to better integrate information from third parties. TI has taken and continues to take reasonable steps to provide representative and accurate information but may not have conducted destructive testing or chemical analysis on incoming materials and chemicals. TI and TI suppliers consider certain information to be proprietary, and thus CAS numbers and other limited information may not be available for release.

In no event shall TI's liability arising out of such information exceed the total purchase price of the TI part(s) at issue in this document sold by TI to Customer on an annual basis.

**OTHER QUALIFIED VERSIONS OF AMC1351-Q1 :**

- Catalog : [AMC1351](#)

NOTE: Qualified Version Definitions:

- Catalog - TI's standard catalog product

**TAPE AND REEL INFORMATION**

**QUADRANT ASSIGNMENTS FOR PIN 1 ORIENTATION IN TAPE**

\*All dimensions are nominal

Device	Package Type	Package Drawing	Pins	SPQ	Reel Diameter (mm)	Reel Width W1 (mm)	A0 (mm)	B0 (mm)	K0 (mm)	P1 (mm)	W (mm)	Pin1 Quadrant
AMC1351QDWVRQ1	SOIC	DWV	8	1000	330.0	16.4	12.05	6.15	3.3	16.0	16.0	Q1

**TAPE AND REEL BOX DIMENSIONS**

\*All dimensions are nominal

Device	Package Type	Package Drawing	Pins	SPQ	Length (mm)	Width (mm)	Height (mm)
AMC1351QDWVRQ1	SOIC	DWV	8	1000	350.0	350.0	43.0



# PACKAGE OUTLINE

DWV0008A



SOIC - 2.8 mm max height

SOIC

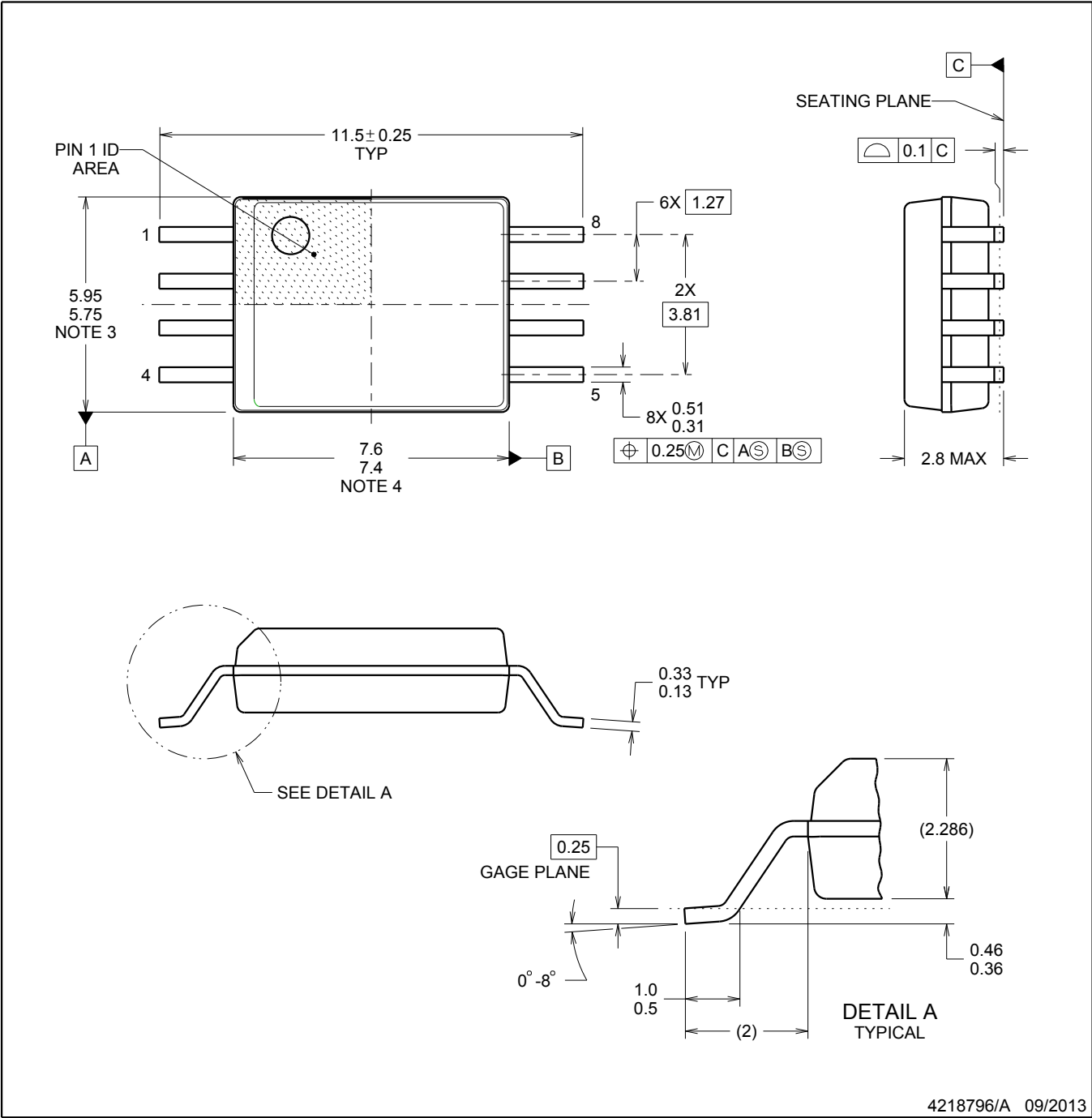

4218796/A 09/2013

**NOTES:**

1. All linear dimensions are in millimeters. Dimensions in parenthesis are for reference only. Dimensioning and tolerancing per ASME Y14.5M.
2. This drawing is subject to change without notice.
3. This dimension does not include mold flash, protrusions, or gate burrs. Mold flash, protrusions, or gate burrs shall not exceed 0.15 mm, per side.
4. This dimension does not include interlead flash. Interlead flash shall not exceed 0.25 mm, per side.



LAND PATTERN EXAMPLE  
9.1 mm NOMINAL CLEARANCE/CREEPAGE  
SCALE:6X

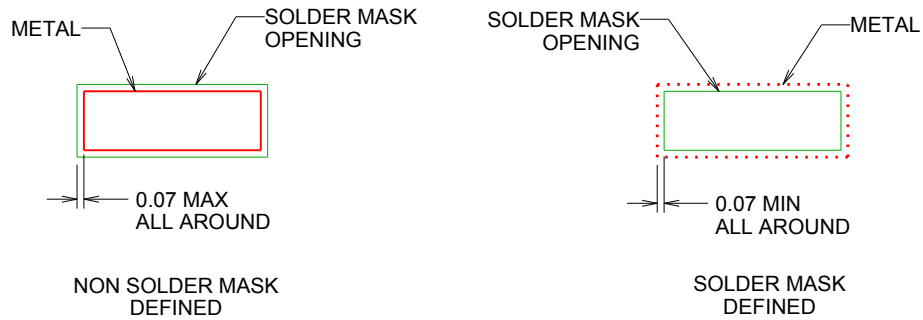

SOLDER MASK DETAILS

4218796/A 09/2013

NOTES: (continued)

- 5. Publication IPC-7351 may have alternate designs.
- 6. Solder mask tolerances between and around signal pads can vary based on board fabrication site.

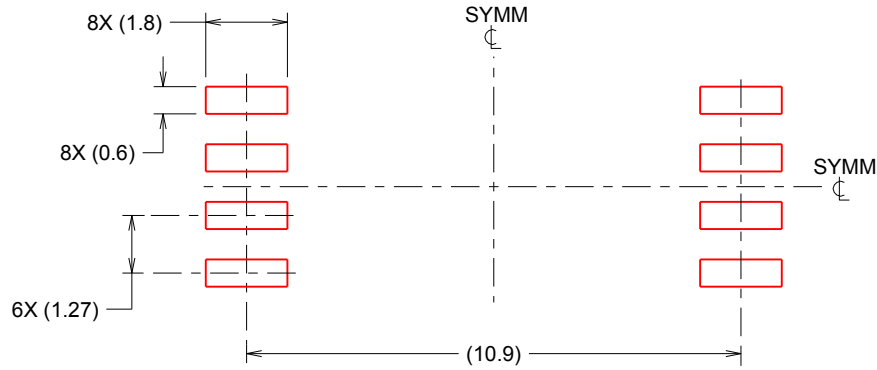

SOLDER PASTE EXAMPLE  
 BASED ON 0.125 mm THICK STENCIL  
 SCALE:6X

4218796/A 09/2013

NOTES: (continued)

- 7. Laser cutting apertures with trapezoidal walls and rounded corners may offer better paste release. IPC-7525 may have alternate design recommendations.
- 8. Board assembly site may have different recommendations for stencil design.

## IMPORTANT NOTICE AND DISCLAIMER

TI PROVIDES TECHNICAL AND RELIABILITY DATA (INCLUDING DATA SHEETS), DESIGN RESOURCES (INCLUDING REFERENCE DESIGNS), APPLICATION OR OTHER DESIGN ADVICE, WEB TOOLS, SAFETY INFORMATION, AND OTHER RESOURCES "AS IS" AND WITH ALL FAULTS, AND DISCLAIMS ALL WARRANTIES, EXPRESS AND IMPLIED, INCLUDING WITHOUT LIMITATION ANY IMPLIED WARRANTIES OF MERCHANTABILITY, FITNESS FOR A PARTICULAR PURPOSE OR NON-INFRINGEMENT OF THIRD PARTY INTELLECTUAL PROPERTY RIGHTS.

These resources are intended for skilled developers designing with TI products. You are solely responsible for (1) selecting the appropriate TI products for your application, (2) designing, validating and testing your application, and (3) ensuring your application meets applicable standards, and any other safety, security, regulatory or other requirements.

These resources are subject to change without notice. TI grants you permission to use these resources only for development of an application that uses the TI products described in the resource. Other reproduction and display of these resources is prohibited. No license is granted to any other TI intellectual property right or to any third party intellectual property right. TI disclaims responsibility for, and you will fully indemnify TI and its representatives against, any claims, damages, costs, losses, and liabilities arising out of your use of these resources.

TI's products are provided subject to [TI's Terms of Sale](#) or other applicable terms available either on [ti.com](http://ti.com) or provided in conjunction with such TI products. TI's provision of these resources does not expand or otherwise alter TI's applicable warranties or warranty disclaimers for TI products.

TI objects to and rejects any additional or different terms you may have proposed.

Mailing Address: Texas Instruments, Post Office Box 655303, Dallas, Texas 75265  
Copyright © 2022, Texas Instruments Incorporated