

**datasheet**

PRODUCT SPECIFICATION

1/9" CMOS VGA (640x480) image sensor  
with OmniPixel3-HS™ technology

OV7675/OV7175



## Copyright © 2009 OmniVision Technologies, Inc. All rights reserved.

This document is provided "as is" with no warranties whatsoever, including any warranty of merchantability, non-infringement, fitness for any particular purpose, or any warranty otherwise arising out of any proposal, specification, or sample.

OmniVision Technologies, Inc. and all its affiliates disclaim all liability, including liability for infringement of any proprietary rights, relating to the use of information in this document. No license, expressed or implied, by estoppel or otherwise, to any intellectual property rights is granted herein.

The information contained in this document is considered proprietary to OmniVision Technologies, Inc. and all its affiliates. This information may be distributed to individuals or organizations authorized by OmniVision Technologies, Inc. to receive said information. Individuals and/or organizations are not allowed to re-distribute said information.

### Trademark Information

OmniVision and the OmniVision logo are registered trademarks of OmniVision Technologies, Inc. OmniPixel3-HS and VarioPixel are trademarks of OmniVision Technologies, Inc.

All other trademarks used herein are the property of their respective owners.

### **CMOS VGA (640 x 480) image sensor with OmniPixel3-HS™ technology**

datasheet (CSP3)  
PRODUCT SPECIFICATION

version 2.0  
october 2009

To learn more about OmniVision Technologies, visit [www.ovt.com](http://www.ovt.com).  
OmniVision Technologies is publicly traded on NASDAQ under the symbol OVTI.



## applications

- cellular phones
- toys
- PC multimedia
- digital still cameras

## ordering information

- **OV07675-A23A** (color, lead-free)  
23-pin CSP3
- **OV07175-A23A** (b&w, lead-free)  
23-pin CSP3

## features

- support for image sizes: VGA (640x480), QVGA (320x240) and QQVGA (160x120)
- support for output formats: YUV4:2:2, Raw RGB, ITU656, RGB565
- digital video port (DVP) parallel output interface
- on-chip phase lock loop (PLL)
- built-in 1.5V regulator for core
- capable of maintaining register values at power down
- programmable controls for frame rate, mirror and flip, AEC/AGC, and windowing
- support for horizontal and vertical sub-sampling
- automatic image control functions: automatic exposure control (AEC), automatic white balance (AWB) and automatic black level calibration (ABLC)
- image quality controls: defect pixel correction and lens shading correction
- support for black sun cancellation
- standard serial SCCB interface
- parallel I/O tri-state configurability and programmable polarity
- module size: 6 mm x 6 mm

## key specifications

- **active array size:** 640x480
- **power supply:**  
analog: 2.6 ~ 3.0V  
core: 1.5V DC  $\pm$  5% (internal regulator)  
I/O: 1.71 ~ 3.0V
- **power requirements:**  
active: 98 mW  
standby: 60  $\mu$ W
- **temperature range:**  
operating: -30°C to 70°C (see [table 8-2](#))  
stable image: 0°C to 50°C (see [table 8-2](#))
- **output formats:** YUV422, Raw RGB, ITU656, RGB565
- **lens size:** 1/9"
- **lens chief ray angle:** 21° (see [figure 10-2](#))
- **input clock frequency:** 1.5 ~ 27 MHz (see [table 8-5](#))
- **scan mode:** progressive
- **maximum image transfer rate:** (see [table 2-1](#) for details)
- **sensitivity:** 1800 mV/(Lux-sec)
- **shutter:** rolling shutter
- **S/N ratio:** 38 dB
- **dynamic range:** 71 dB
- **maximum exposure interval:** 510 x  $t_{ROW}$
- **pixel size:** 2.5  $\mu$ m x 2.5  $\mu$ m
- **dark current:** 10 mV/sec @ 60°C
- **well capacity:** 12 Ke<sup>-</sup>
- **fixed pattern noise (FPN):** 1% of  $V_{PEAK-TO-PEAK}$
- **image area:** 1640  $\mu$ m x 1220  $\mu$ m
- **package dimensions:** 2815 x 2825  $\mu$ m

**OV7675/OV7175**

CMOS VGA (640 x 480) image sensor with OmniPixel3-HS™ technology

## table of contents

<b>1</b>	<b>signal descriptions</b>	<b>1-1</b>
<b>2</b>	<b>system level description</b>	<b>2-1</b>
2.1	format and frame rate	2-3
2.2	power up sequence	2-3
2.2.1	power up with internal DVDD	2-3
2.3	power management	2-4
2.4	power ON reset generation	2-4
2.5	DOVDD power requirements	2-4
2.6	system clock control	2-4
<b>3</b>	<b>block level description</b>	<b>3-1</b>
3.1	pixel array structure	3-1
<b>4</b>	<b>image sensor core digital functions</b>	<b>4-1</b>
4.1	mirror and flip	4-1
4.2	image windowing	4-2
4.3	test pattern	4-3
4.4	AEC/AGC algorithms	4-4
4.4.1	exposure control	4-4
4.4.2	exposure time	4-4
4.4.3	banding filter	4-4
4.4.4	manual exposure control	4-6
4.4.5	automatic exposure control (AEC)	4-6
4.4.6	average based AEC/AGC	4-7
4.4.7	gain control	4-8
4.4.8	automatic gain control (AGC)	4-8
<b>5</b>	<b>image sensor processor digital functions</b>	<b>5-1</b>
5.1	white balance control	5-1
5.2	automatic white balance	5-1
5.3	manual white balance	5-2
5.4	gamma control	5-2
5.5	gamma slope calculation	5-3
5.6	color matrix	5-4
5.6.1	RGB to YUV conversion matrix	5-5
5.7	lens correction (LENC)	5-5

<b>6 image sensor output interface digital functions</b>	<b>6-1</b>
6.1 digital video port (DVP)	6-1
6.1.1 overview	6-1
6.1.2 VGA timing	6-1
<b>7 register tables</b>	<b>7-1</b>
<b>8 operating specifications</b>	<b>8-1</b>
8.1 absolute maximum ratings	8-1
8.2 functional temperature	8-1
8.3 DC characteristics	8-2
8.4 AC characteristics	8-3
<b>9 mechanical specifications</b>	<b>9-1</b>
9.1 physical specifications	9-1
9.2 IR reflow specifications	9-2
<b>10 optical specifications</b>	<b>10-1</b>
10.1 sensor array center	10-1
10.2 lens chief ray angle (CRA)	10-2



## list of figures

figure 1-1	pin diagram	1-2
figure 2-1	OV7675/OV7175 block diagram	2-1
figure 2-2	reference design schematic (CSP3)	2-2
figure 2-3	power up timing with internal DVDD	2-3
figure 3-1	sensor array region color filter layout	3-1
figure 4-1	mirror and flip samples	4-1
figure 4-2	image windowing	4-2
figure 4-3	test pattern	4-3
figure 4-4	average based AEC/AGC	4-7
figure 5-1	gamma curve	5-2
figure 5-2	lens correction function	5-6
figure 6-1	VGA timing diagram	6-1
figure 6-2	QVGA timing diagram	6-1
figure 6-3	QQVGA timing diagram	6-2
figure 9-1	package specifications	9-1
figure 9-2	IR reflow ramp rate requirements	9-2
figure 10-1	sensor array center	10-1
figure 10-2	chief ray angle (CRA)	10-2



## list of tables

table 1-1	signal descriptions	1-1
table 2-1	format and frame rate	2-3
table 2-2	DOVDD power requirements	2-4
table 4-1	image windowing control functions	4-1
table 4-2	image windowing control functions	4-2
table 4-3	test pattern selection control	4-3
table 4-4	exposure time registers	4-5
table 4-5	exposure control mode registers	4-6
table 4-6	average based AEC/AGC registers	4-7
table 4-7	AGC general control registers	4-8
table 5-1	white balance control registers	5-1
table 5-2	related registers and parameters registers	5-3
table 5-3	color matrix related register and parameter	5-4
table 5-4	LENC related registers	5-5
table 7-1	system control registers	7-1
table 8-1	absolute maximum ratings	8-1
table 8-2	functional temperature	8-1
table 8-3	DC characteristics (-30°C < TA < 70°C)	8-2
table 8-4	AC characteristics (TA = 25°C, VDD-A = 2.8V, VDD-IO = 2.8V)	8-3
table 8-5	timing characteristics	8-3
table 9-1	package dimensions	9-1
table 9-2	reflow conditions	9-2
table 10-1	CRA versus image height plot	10-2



# 1 signal descriptions

**table 1-1** lists the signal descriptions and their corresponding pin numbers for the OV7675/OV7175 image sensor. The package information is shown in **section 9**.

**table 1-1** signal descriptions

pin number	signal name	pin type	description
A1	SCL	input	SCCB clock input
A2	SDA	I/O	SCCB data
A3	AGND	ground	analog ground
A4	VREF1	reference	internal reference: through a 0.1 $\mu$ F capacitor to analog ground
A5	D0	I/O	bit[0] of parallel output port / input (LSB)
B1	NC	–	no connect
B2	AVDD	power	analog power (2.6 ~ 3.0V)
B3	PWDN	input	power down, active high (hardware standby when PWDN is high)
B4	D2	I/O	bit[2] of parallel output port / input
B5	D1	I/O	bit[1] of parallel output port / input
C3	VREF2	reference	internal reference: through a 0.1 $\mu$ F capacitor to analog ground
C4	XVCLK	input	system clock input
C5	D3	I/O	bit[3] of parallel output port / input
D1	NC	–	no connect
D2	PCLK	I/O	pixel clock output / input
D3	D6	I/O	bit[6] of parallel output port / input
D4	D4	I/O	bit[4] of parallel output port / input
D5	DGND	ground	digital core logic and I/O ground
E1	HREF	I/O	horizontal reference (data valid) output
E2	VSYNC	I/O	vertical synchronization (VSYNC)
E3	D7	I/O	bit[7] of parallel output port / input (MSB)
E4	D5	I/O	bit[5] of parallel output port / input
E5	DOVDD	power	power of I/O circuit (1.7 ~ 3.0V)

figure 1-1 pin diagram

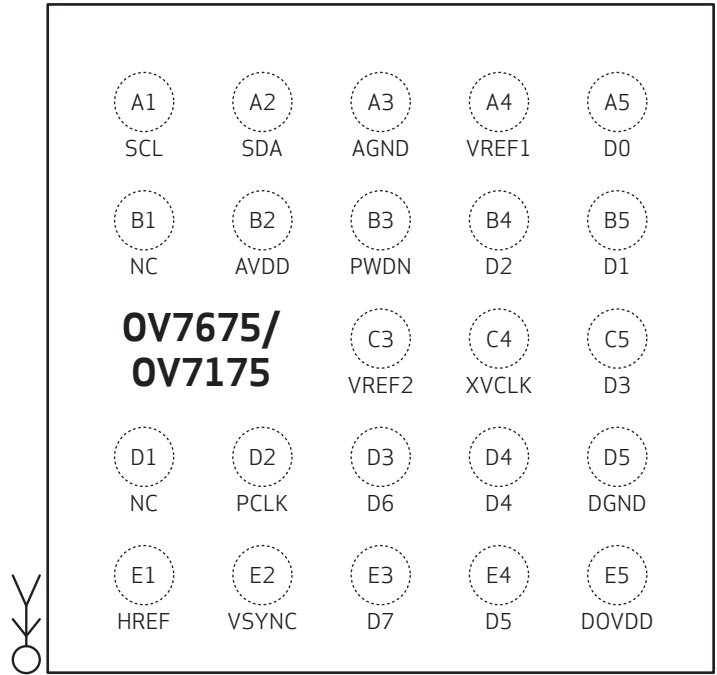

7675\_CSP\_DS\_1\_1

## 2 system level description

The OV7675 (color) and OV7175 (b&w) image sensors are low voltage, high-performance 1/9-inch VGA CMOS image sensors that provides the full functionality of a single chip VGA (640x480) camera using OmniPixel3-HS™ technology in a small footprint package. They provide full-frame, sub-sampled, windowed and images in VGA, QVGA and QQVGA formats via the control of the Serial Camera Control Bus (SCCB) interface.

The OV7675/OV7175 has an image array capable of operating at up to 30 frames per second (fps) in VGA resolution with complete user control over image quality, formatting and output data transfer. All required image processing functions, including exposure control, gamma, white balance, color saturation, hue control, defective pixel canceling, noise canceling, etc., are programmable through the SCCB interface. In addition, OmniVision image sensors use proprietary sensor technology to improve image quality by reducing or eliminating common lighting/electrical sources of image contamination, such as fixed pattern noise, smearing, etc., to produce a clean, fully stable, color image.

figure 2-1 OV7675/OV7175 block diagram

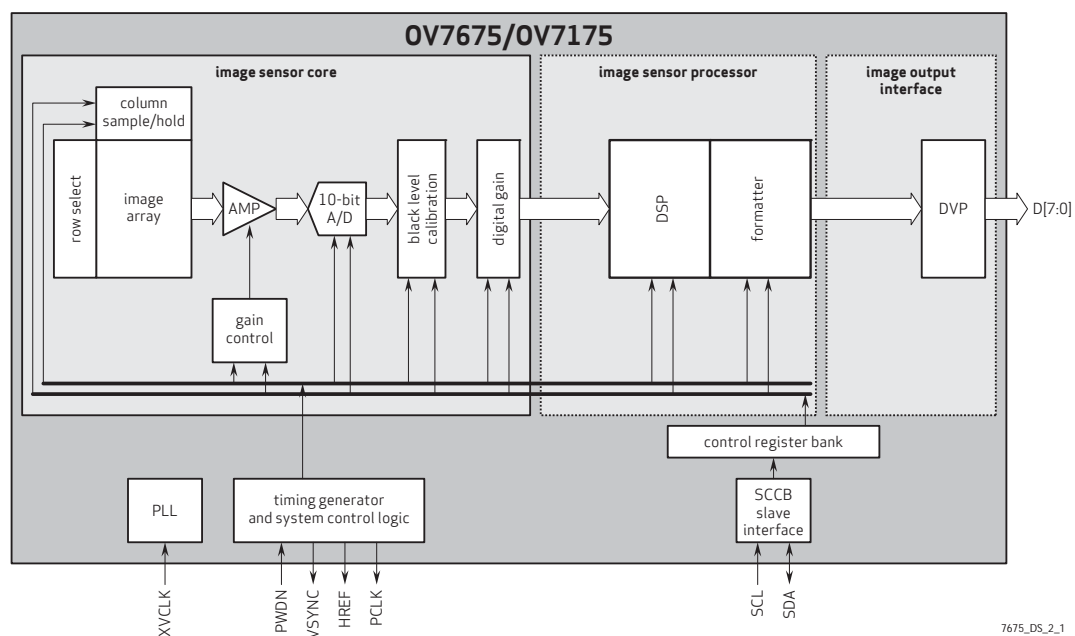
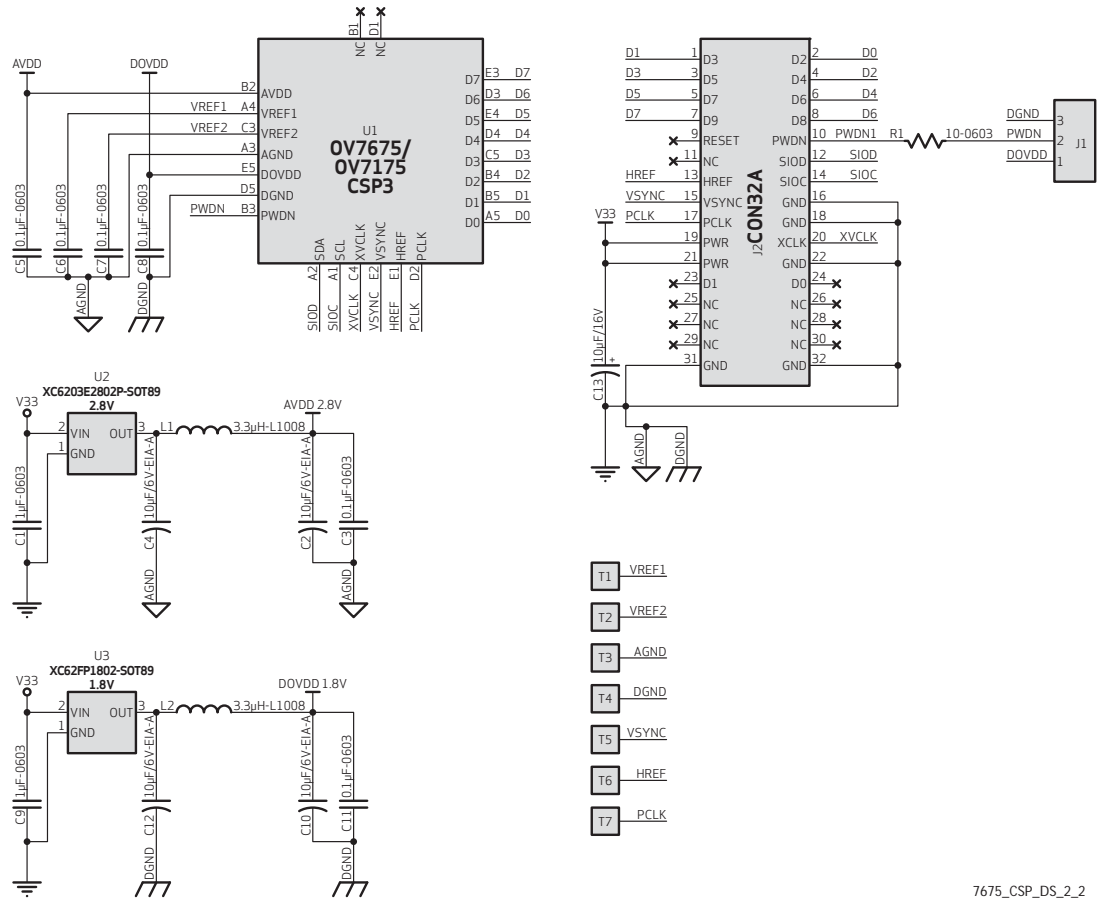

figure 2-2 reference design schematic (CSP3)



7675\_CSP\_DS\_2\_2



## 2.1 format and frame rate

The OV7675/OV7175 supports the following formats YUV422, RAW RGB, ITU656, and RGB565.

**table 2-1** format and frame rate

format	resolution	frame rate	scaling method	pixel clock (YUV/RAW)
VGA	640x480	30 fps	full	24/12 MHz
QVGA	320x240	60 fps	sub sampling from VGA	24/12 MHz
QQVGA	160x120	240 fps	cropped and window from center of VGA	24/12 MHz

## 2.2 power up sequence

### 2.2.1 power up with internal DVDD

When powering up with the internal DVDD and SCCB access during the power ON period, the following conditions must occur:

1. if  $V_{DD-IO}$  and  $V_{DD-A}$  are turned ON at the same time, make sure  $V_{DD-IO}$  becomes stable before  $V_{DD-A}$  becomes stable
2. PWDN is active high with an asynchronized design (does not need clock)
3. PWDN must go high during the power up period
4. for PWDN to go low, power up must first become stable ( $AVDD$  to PWDN  $\geq 5$  ms)
5. master clock XVCLK should provide at least 1 ms before host accesses sensor's I2C
6. host can access I2C bus (if shared) during entire period. 20 ms after PWDN goes low goes high if reset is inserted after PWDN goes low, host can access sensor's SCCB to initialize sensor

**figure 2-3** power up timing with internal DVDD

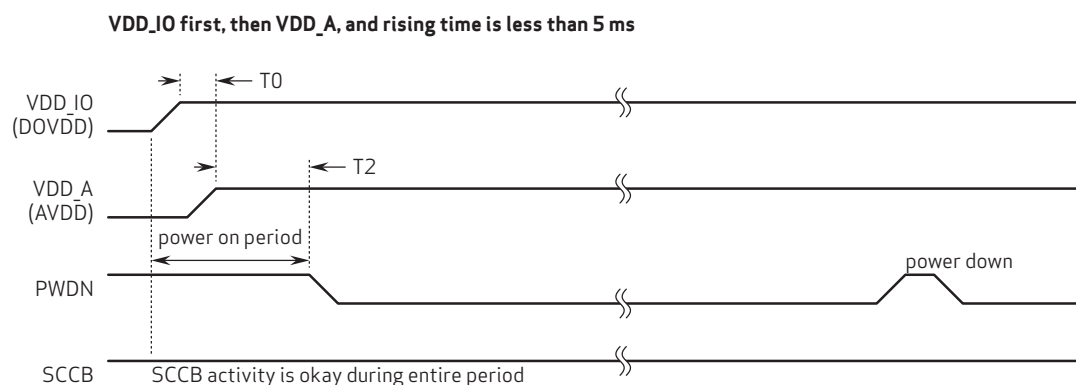

**note**  $T0 \geq 0$  ms: delay from VDD\_IO stable to VDD\_A stable  
 $T2 \geq 5$  ms: delay from VDD\_A stable to sensor power up stable  
 if PWDN is not used, sensor SCCB is accessible after  $T0 + T2$

7675\_DS\_2\_3

## 2.3 power management

The OV7675/OV7175 requires 2.8V (typical) for analog and 1.8V or 2.8V (typical) for I/O. The internal regulator provides 1.5V for core logic with I/O power (DOVDD).

The OV7675/OV7175 includes built-in power management circuitry to optimize battery life. Only system related functions are always powered on. Sensor and ISP functions are powered off in power down mode. Also, during the power on sequence of the whole device, these functions are powered on after system functions are powered on.

During power down, values of all the registers are maintained and are restored after the sensor power is resumed. In power down mode, the clock input from the system can be turned OFF inside the sensor even if the external clock source is still clocking.

## 2.4 power ON reset generation

The OV7675/OV7175 includes an on-chip initial power-on reset feature, which will automatically detect core power at stable state and reset the image sensor.

## 2.5 DOVDD power requirements

The OV7675/OV7175 requires two power supplies, AVDD and DOVDD. For different DOVDD registers 0xB8[6:3] must be set to the settings in [table 2-2](#).

**table 2-2** DOVDD power requirements

DOVDD	0xB8[6:3]
1.8 V	4'h1
2.8 V	4'h2

## 2.6 system clock control

The OV7675/OV7175 has on-chip PLL which generates the system clock with 6~27 MHz input clock. A programmable clock divider is needed to generate a different frequency for the system. For input clock lower than 6 MHz ( $1.5 \leq XVCLK < 6$ ), PLL should be bypassed.

## 3 block level description

### 3.1 pixel array structure

The OV7675/OV7175 sensor has an image array of 656 columns by 504 rows (330,624 pixels). **figure 3-1** shows a cross-section of the image sensor array.

The color filters are arranged in a Bayer pattern. The primary color BG/GR array is arranged in line-alternating fashion. Of the 330,624 pixels, 322,752 (656x492) are active pixels and can be output.

The sensor array design is based on a field integration read-out system with line-by-line transfer and an electronic shutter with a synchronous pixel read-out scheme.

**figure 3-1** sensor array region color filter layout

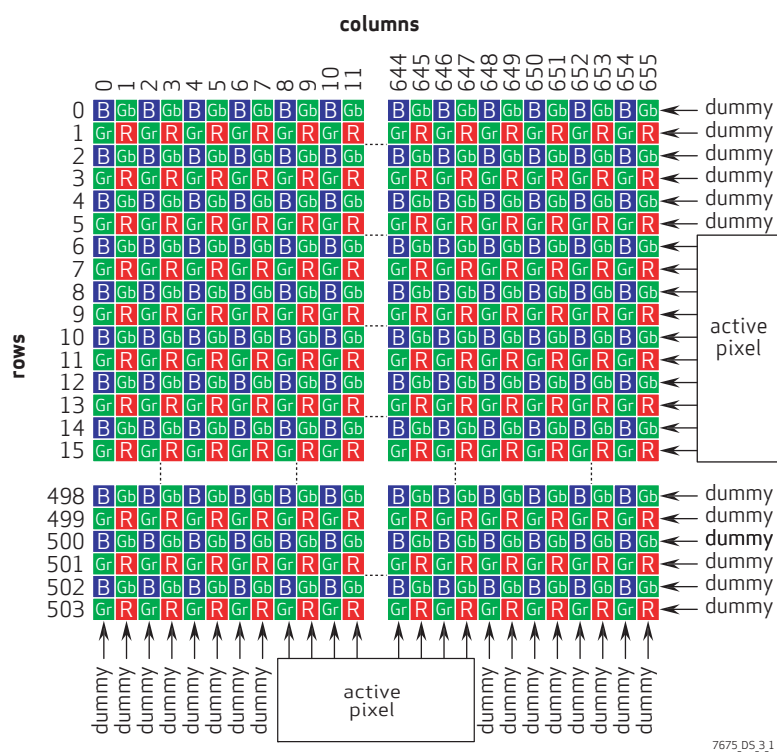



## 4 image sensor core digital functions

### 4.1 mirror and flip

The OV7675/OV7175 provides Mirror and Flip read-out modes, which respectively reverse the sensor data read-out order horizontally and vertically (see [figure 4-1](#)).

**figure 4-1** mirror and flip samples

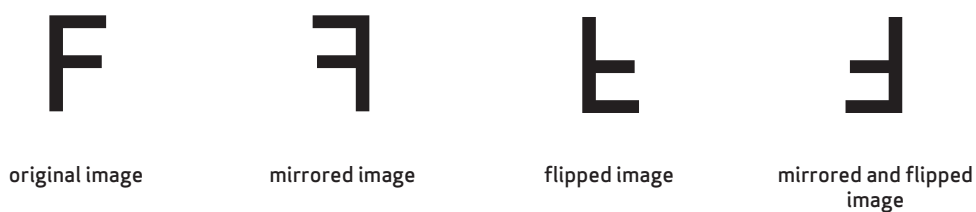

7675\_DS\_4\_1

**table 4-1** image windowing control functions

address	register name	default value	R/W	description
0x1E	MVFP	0x01	RW	Mirror/VFlip Enable Bit[5]: Mirror 0: Normal image 1: Mirror image Bit[4]: VFlip enable 0: Normal image 1: Vertically flip image

## 4.2 image windowing

The OV7675/OV7175 windowing feature allows the users to define the active pixels used in the final image (frame) as required for low-resolution applications. Selecting the Start/Stop Row/Column addresses (modifying window size and/or position) does not change the frame or data rate. When windowing is enabled, the HREF signal is asserted to be consistent with the programmed 'active' horizontal and vertical region.

figure 4-2 image windowing

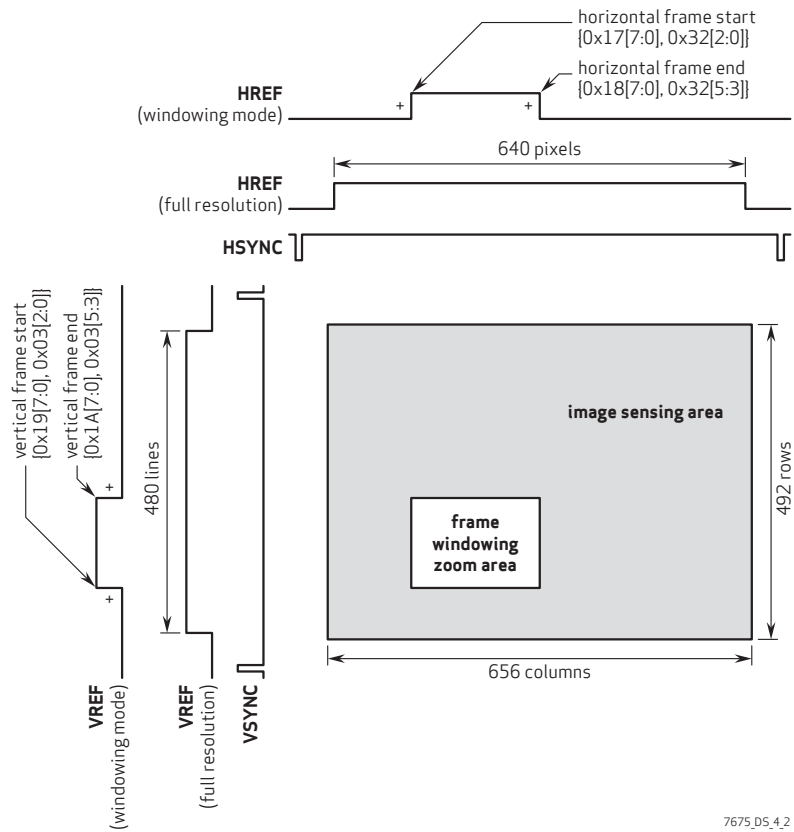

table 4-2 image windowing control functions

register address	description
0x17[7:0], 0x32[2:0]	horizontal frame (HREF column) start
0x18[7:0], 0x32[5:3]	horizontal frame (HREF column) stop
0x19[7:0], 0x03[2:0]	vertical frame (row) start
0x1A[7:0], 0x03[5:3]	vertical frame (row) stop

## 4.3 test pattern

For testing purposes, the OV7675 offers one type of test pattern, color bar.

**figure 4-3** test pattern

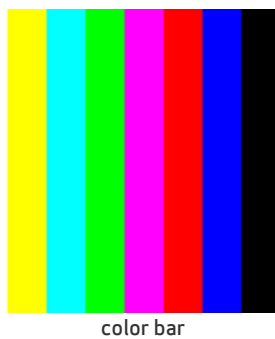

**table 4-3** test pattern selection control<sup>a</sup>

address	register name	default value	R/W	description
0x71	COM17	0x00	RW	Bit[7]: Color bar enable 0: Disabled 1: Enabled

a. only for VGA

## 4.4 AEC/AGC algorithms

### 4.4.1 exposure control

The OV7675/OV7175 supports both automatic and manual exposure control modes. The exposure time is defined as the interval from the cell pre-charge to the end of the photo-induced current measurement and can be controlled manually or by using the AEC function. This exposure control uses a 'rolling' shutter, which means the exposure time is set on a row-by-row basis rather than on a frame-by-frame basis.

### 4.4.2 exposure time

Exposure time unit is the interval of row, as shown below.

$$t_{\text{Exposure}} = \text{AEC}[15:0] \times t_{\text{Row interval}}$$

where AEC[15:0] is set by register {0x07[5:0], 0x10[7:0], 0x04[1:0]}

$$\text{AEC}[15:0] = \{0x07[5:0], 0x10[7:0], 0x04[1:0]\}$$

The OV7675 array always output, VGA resolution, the row interval is

$$t_{\text{Row interval}} = 2 \times (784 + \text{Dummy Pixels}) \times t_{\text{INT CLK}},$$

and AEC[15:0] is limited by the number of rows of VGA resolution plus the number of dummy lines.

Note that both the AEC and AGC functions are interactive so registers and functions may be common to both. Also, in general, the AEC is the primary control and will be adjusted before the AGC (AGC acts to adjust and center the AEC).

The algorithm used for the electronic exposure control is based on luminance of the full, center quarter, or center half image. The exposure is optimized for a "normal" scene that assumes the subject is well lit relative to the background.

### 4.4.3 banding filter

The OV7675/OV7175 also provides a rolling horizontal band eliminate function in auto exposure mode. A banding filter is deployed to filter out the banding effect caused by the 50/60 Hz lighting. To enable this function, register 0x13[5] must be set to high. The OV7675/OV7175 only supports manual banding filter.

In 50 or 60Hz flicker light, the exposure time must be a multiple of the flicker interval to avoid band shown on the image. For 50Hz light, the exposure time must be

$$t_{\text{Exposure}} = N/100$$

and for 60Hz light, the exposure time must be

$$t_{\text{Exposure}} = N/120$$

where N is a positive integer.



Since the exposure time AEC[15:0] is based on row interval, the AEC needs to know 1/100 second and 1/120 second is equal to how many rows. Banding filter registers, BD50st and BD60st, are used to set 1/100 and 1/120 second. The banding filter can be calculated by:

$$\text{banding filter value} = \frac{1}{120 \times t_{\text{Row interval}}} = \frac{\text{framerate} \times \text{maximum exposure}}{120} \quad \text{for 60Hz}$$

$$\text{banding filter value} = \frac{1}{100 \times t_{\text{Row interval}}} = \frac{\text{framerate} \times \text{maximum exposure}}{100} \quad \text{for 50Hz}$$

where maximum exposure equals to the number of lines per frame plus the number of dummy lines minus 2.

The OV7675/OV7175 can also disable the banding filter to allow for any exposure time value. When banding filter is enabled, the OV7675/OV7175 also allows the exposure time to be less than 1/120 or 1/100 second under strong light condition, by setting register 0x13[4] to 1.

**table 4-4** summarizes the registers of exposure time and how to set the banding filter.

**table 4-4** exposure time registers (sheet 1 of 2)

address	register name	description
0x04	COM1	Bit[1:0]: Exposure time, the unit is $t_{\text{Row interval}}$ AEC[15:0] = {0x07[5:0], 0x10[7:0], 0x04[1:0]}
0x10	AEC	Bit[7:0]: Exposure time, the unit is $t_{\text{Row interval}}$ AEC[15:0] = {0x07[5:0], 0x10[7:0], 0x04[1:0]}
0x07	AECHH	Bit[5:0]: Exposure time, the unit is $t_{\text{Row interval}}$ AEC[15:0] = {0x07[5:0], 0x10[7:0], 0x04[1:0]}
0x13	COM8	Bit[5]: Banding filter enable/disable 0: Disable banding filter, the exposure time can be any number 1: Enable banding filter, the exposure time must be N/100 or N/120 second.
0x3B	COM11	Bit[3]: Manual banding filter selection (effective only when COM11[4] = 0) 0: Select the value of register 0x50 as banding filter (60Hz) 1: Select the value of register 0x4F as banding filter (50Hz)
0xE1	REGE1	Bit[1:0]: Banding filter for 50Hz[9:8] Banding filter for 50Hz[9:0] = (0xE1[1:0], 0x9D[7:0])
0x9D	BD50ST	Bit[7:0]: Banding filter for 50Hz[7:0] Banding filter for 50Hz[9:0] = (0xE1[1:0], 0x9D[7:0])
0xE1	REGE1	Bit[3:2]: Banding filter for 60Hz[9:8] Banding filter for 60Hz[9:0] = (0xE1[3:2], 0x9E[7:0])
0x9E	BD60ST	Bit[7:0]: Banding filter for 60Hz[7:0] Banding filter for 60Hz[9:0] = (0xE1[3:2], 0x9E[7:0])

**table 4-4** exposure time registers (sheet 2 of 2)

address	register name	description
0xA5	BD50MAX	Bit[7:0]: Banding filter maximum step for 50Hz light source
0xAB	BD60MAX	Bit[7:0]: Banding filter maximum step for 60Hz light source
0x3B	COM11	Bit[1]: Exposure time option 0: Limit the minimum exposure time to 1/100 or 1/120 second in any light condition when banding filter is enabled 1: Allow exposure time to be less than 1/100 or 1/120 second under strong light conditions when banding filter is enabled

#### 4.4.4 manual exposure control

The OV7675/OV7175 works in manual exposure mode when register 0x13[0] is low. In manual exposure control mode the companion backend processor can fully control the OV7675/OV7175 image exposure. The companion backend processor may write exposure values to AEC [15:0] according to its corresponding Automatic Exposure Control (AEC) algorithm.

The companion processor also needs to set correct exposure time to avoid banding in flicker light. Refer to section 3.3.1 and 3.3.2 for the exposure time calculation.

#### 4.4.5 automatic exposure control (AEC)

The AEC function allows for the image sensor to adjust the exposure without external command or control. The OV7675/OV7175 supports average based AEC. Note that both AEC and AGC functions are controlled by the same algorithm and share the same registers of the algorithm parameter. In general, the AEC is the primary control and will be adjusted before the AGC (AGC acts to adjust and center the AEC).

**table 4-5** exposure control mode registers

address	register name	description
0x13	COM8	Bit[7]: AEC operation speed 0: Normal speed 1: Fast speed
0x13	COM8	Bit[6]: AEC step size limit 0: Unlimited step size 1: Step size limited to vertical bank
0x13	COM8	Bit[3]: Pixel level exposure ON/OFF selection 0: Limit the minimum exposure time to 1 line 1: Allow exposure time less than 1 line
0x13	COM8	Bit[0]: AEC enable 0: Disable AEC 1: Enable AEC

The average based AEC/AGC defines the fast operating region in which the AEC/AGC adjusts the image luminance very fast by increasing the exposure time and gain adjustment.

#### 4.4.6 average based AEC/AGC

As shown in **figure 4-4**, the average based AEC/AGC algorithm makes the average value of the luminance converge to the Stable Operating Region step by step. Outside the Control Zone, the AEC/AGC adjusts exposure time and gain by big steps to lower luminance quickly. Inside the Control Zone and outside the Stable Operating range, the AEC/AGC adjusts exposure time and gain by small step to make the luminance level converge to the Stable Operating Region smoothly. Inside Stable Operating Region, the AEC/AGC does not adjust exposure time and gain anymore. **table 4-6** summarizes the control registers of the average based AEC/AGC.

**figure 4-4** average based AEC/AGC

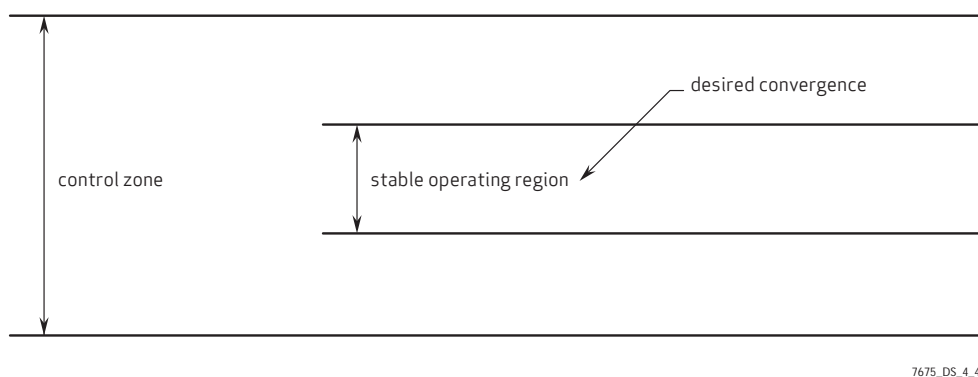

**table 4-6** average based AEC/AGC registers

address	register name	description
0x24	AEW	Bit[7:0]: Upper limit of the Stable Operating Region
0x25	AEB	Bit[7:0]: Lower limit of the Stable Operating Region
0x26	VPT	Bit[7:4]: High nibble of upper limit of fast mode control zone The upper limit is {0x26[7:4], 4'h0}
0x26	VPT	Bit[3:0]: High nibble of lower limit of fast mode control zone The lower limit is {0x26[3:0], 4'h0}
0x0D	COM4	Bit[5:4]: Average option (must be same value as 0x0D[7:6]) 00: Full window 01: 1/2 window 1x: 1/4 window
0x42	COM17	Bit[5:4]: Average option (must be same value as 0x42[5:4]) 00: Full window 01: 1/2 window 1x: 1/4 window

#### 4.4.7 gain control

The OV7675/OV7175 supports both automatic gain control (AGC) and manual gain control modes.

##### 4.4.7.1 manual gain control

The manual gain control mode allows for the companion backend processor to control the OV7675/OV7175 gain value. The companion backend chip can write gain values to register {0x03[7:6],0x00[7:0]} according to its gain control algorithm. The formula to calculate gain from register value is:

$$\text{gain} = (0x03[7] + 1) \times (0x03[6] + 1) \times (0x00[7] + 1) \times (0x00[6] + 1) \times (0x00[5] + 1) \times (0x00[4] + 1) \times \left( \frac{0x00[3:0]}{16} + 1 \right)$$

The gain to register value correlation is shown in [table 4-7](#).

#### 4.4.8 automatic gain control (AGC)

The AGC function allows the image sensor to adjust image luminance by changing gain without external command or control. Register setting 0x13[2] enables or disables AGC function. When AGC function is enabled, gain is automatically adjusted and the result is saved in register 0x00[6:0]. The maximum gain is limited by gain ceiling (refer to [table 4-7](#)). When the AGC function is disabled, the gain control is still active, and user can change the gain setting.

The AGC uses the same algorithm as the AEC and shares most of the control registers with the AEC. [table 4-7](#) summarizes the general controls for the AGC. To achieve best image quality, the sensor always increases exposure time prior to gain and reduces gain prior to exposure time.

**table 4-7** AGC general control registers

address	register name	description
0x13	REG13	Bit[2]: AGC function auto/manual selection 0: manual gain control 1: automatic gain control enable
0x00	GAIN	Bit[7:0]: Gain setting. Read-only when AGC is enabled. When AGC is disabled, these registers can be programmed manually $\text{gain} = (0x03[7] + 1) \times (0x03[6] + 1) \times (0x00[7] + 1) \times (0x00[6] + 1) \times (0x00[5] + 1) \times (0x00[4] + 1) \times \left( \frac{0x00[3:0]}{16} + 1 \right)$
0x03	VREF	Bit[7:6]: Gain setting. Read-only when AGC is enabled. When AGC is disabled, these registers can be programmed manually $\text{gain} = (0x03[7] + 1) \times (0x03[6] + 1) \times (0x00[7] + 1) \times (0x00[6] + 1) \times (0x00[5] + 1) \times (0x00[4] + 1) \times \left( \frac{0x00[3:0]}{16} + 1 \right)$
0x14	REG14	Bit[6:4]: Automatic gain ceiling - maximum AGC value 000: 2x 001: 4x 010: 8x 011: 16x 100: 32x 101: 64x 110: 128x 111: Not used

## 5 image sensor processor digital functions

### 5.1 white balance control

The OV7675/OV7175 supports Automatic White Balance (AWB) function. The AWB circuit automatically adjusts red, green and blue gain to make white target be white regardless of the lighting. The OV7675/OV7175 supports both automatic and manual mode. In AWB mode, after the initial pixel level adjustment, the Red and Blue channel gains are optimized to the Green channel to set the white balance. When AWB function is disabled, the user can also manually adjust red, green and blue gain to make image White Balanced. Following is the summary of the two White Balance modes.

- Manual mode: Red, Green and Blue gain are set manually
- Automatic mode: Red, Green and Blue gain are controlled by the AWB circuit. The AWB circuit adjusts the gain to make red, green and blue average values equal based on a grey world assumption

### 5.2 automatic white balance

In general, the white balance is done in two steps: by first adjusting the Red/Blue gain to match the green channel and then by controlling the AWB response time. **table 5-1** is the common control registers of White Balance.

**table 5-1** white balance control registers

sub register address	default value	description
COM8	0x13	Bit[1]: AWB enable 0: Disable AWB, White Balance is in manual mode 1: Enable AWB, White Balance is in auto mode
COM16	0x41	Bit[3]: AWB gain enable has to be enabled in both manual and automatic white balancing mode. When AWB gain is bypassed, image output will be based on the default R/G/B gain (1x). 0: Bypass AWB gain 1: AWB gain enabled
BLUE	0x01	Bit[7:0]: Blue gain Auto mode: gain value updates automatically Manual mode: gain value determined by user. Blue Gain = BLUE[7:0] / 0x40, BLUE[7:0] ≥ 0x40
RED	0x02	Bit[7:0]: Red gain Auto mode: gain value updates automatically Manual mode: gain value determined by user. Red Gain = RED[7:0] / 0x40, RED[7:0] ≥ 0x40
GREEN	0x6A	Bit[7:0]: Green gain Auto mode: gain value updates automatically Manual mode: gain value determined by user. Green Gain = GREEN[7:0] / 0x40, GREEN[7:0] ≥ 0x40

### 5.3 manual white balance

In manual mode, the companion backend processor can control the OV7675/OV7175 internal Red, Green and Blue gain register values to achieve white balance. The gain is calculated by the equation below:

$$\text{Gain} = \text{Register Value} / 0x40$$

Since the gain is digital gain, always set the minimum gain of the three channels to 1x and do not apply less than 1x gain to any channel.

### 5.4 gamma control

The OV7675 gamma curve is composed of approximately 16 linear segments as shown in **figure 5-1** and **table 5-1**.

**figure 5-1** gamma curve

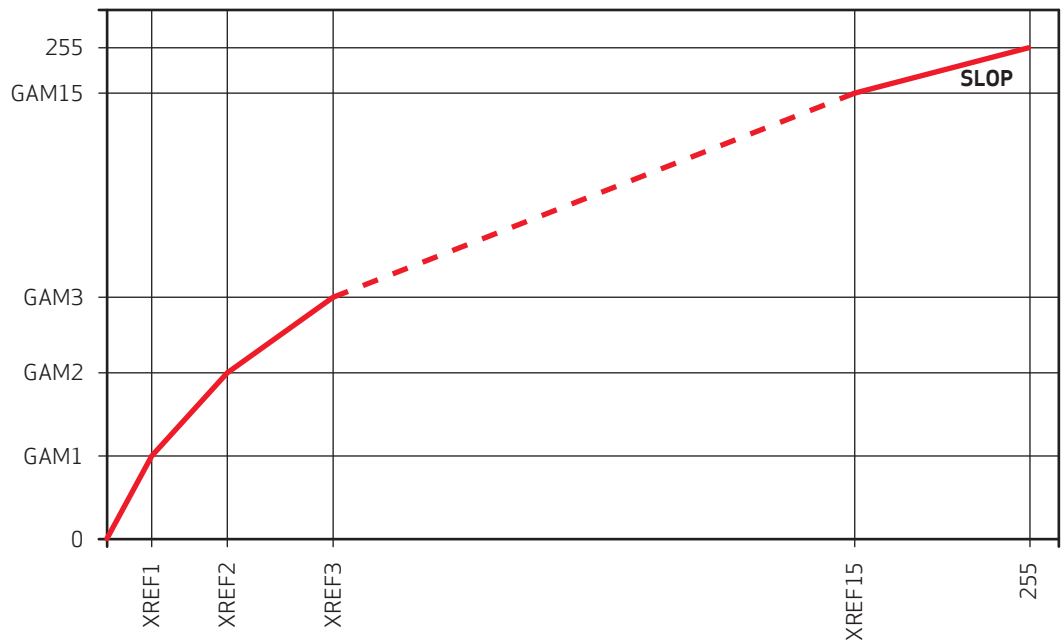

7675\_DS\_5\_1

**table 5-2** related registers and parameters registers

gamma segments Y coordinates		gamma segments X coordinates	
register	address	name	value
DSP_CTL0	0x60[1]	gamma function enabled	0: gamma disabled 1: gamma enabled
GAM1	0x7B	XREF1	4
GAM2	0x7C	XREF2	8
GAM3	0x7D	XREF3	16
GAM4	0x7E	XREF4	32
GAM5	0x7F	XREF5	40
GAM6	0x80	XREF6	48
GAM7	0x81	XREF7	56
GAM8	0x82	XREF8	64
GAM9	0x83	XREF9	72
GAM10	0x84	XREF10	80
GAM11	0x85	XREF11	96
GAM12	0x86	XREF12	112
GAM13	0x87	XREF13	144
GAM14	0x88	XREF14	176
GAM15	0x89	XREF15	208
SLOP	0x7A	SLOP = (256 – GAM15) * 40/30	

## 5.5 gamma slope calculation

The highest segment slope (register SLOP 0x81) is calculated by the following equation:

$$\text{SLOP}[7:0] = (255 - \text{GAM15}[7:0]) * 40/30$$

## 5.6 color matrix

The color matrix is used to eliminate the cross talk induced by the micro-lens and color filter process. It also compensates for lighting and temperature effects. Hue, color saturation, color space conversion from RGB to YUV/YCbCr can be also combined with the color matrix.

The OV7675 matrix circuit is active in YUV/YCbCr and other formats are derived from YUV/YCbCr (refer to the equation below).

$$\begin{bmatrix} V \\ U \end{bmatrix} \text{ or } \begin{bmatrix} Cr \\ Cb \end{bmatrix} = \text{ColorMatrix} \begin{bmatrix} R \\ G \\ B \end{bmatrix}$$

where color matrix =

$$\begin{bmatrix} \text{MTX1} & \text{MTX2} & \text{MTX3} \\ \text{MTX4} & \text{MTX5} & \text{MTX6} \end{bmatrix}$$

Since the Y signal is not from color matrix, the sensor generates Y signal from the original RGB directly. The color matrix performs the color correction, RGB to YUV/YCbCr conversion, hue and color saturation control. Though the Y signal is not from the color matrix, the calculation should be done by 3x3 matrix to get the combined matrix as shown below:

$$\text{Combined Matrix} = \text{Saturation Matrix} \times \text{Hue Matrix} \times \text{Conversion Matrix} \times \text{Correction Matrix}$$

and then take the two rows for UV/CbCr as the final color matrix.

**table 5-3** lists all the color matrix related registers. Each matrix element has 9 bits, 1 sign bit and 8 data bits. The register value is equal to 128 times the real color matrix value.

**table 5-3** color matrix related register and parameter

address	register name	reset value	description
0x4F	MTX1	0x40	Bit[7:0]: Matrix coefficient 1
0x50	MTX2	0x34	Bit[7:0]: Matrix coefficient 2
0x51	MTX3	0x0c	Bit[7:0]: Matrix coefficient 3
0x52	MTX4	0x17	Bit[7:0]: Matrix coefficient 4
0x53	MTX5	0x29	Bit[7:0]: Matrix coefficient 5
0x54	MTX6	0x40	Bit[7:0]: Matrix coefficient 6
0x58	MTX_CTRL[5:0]	0x00	Sign Bit for Matrix Coefficient
		0x01	Bit[5]: Sign bit for MTX6
		0x01	Bit[4]: Sign bit for MTX5
		0x01	Bit[3]: Sign bit for MTX4
		0x01	Bit[2]: Sign bit for MTX3
		0x01	Bit[1]: Sign bit for MTX2
		0x00	Bit[0]: Sign bit for MTX1



### 5.6.1 RGB to YUV conversion matrix

The color conversion matrix can be derived from the standard equations below:

$$Y = 0.59G + 0.31R + 0.11B$$

$$U = B - Y$$

$$V = R - Y$$

$$Cr = 0.713 (R - Y)$$

$$Cb = 0.563 (B - Y)$$

## 5.7 lens correction (LENC)

The main purpose of the Lens Correction (LENC) function is to compensate for lens imperfection. According to the radius of each pixel to the lens, the module calculates a gain for the pixel, correcting each pixel with its gain calculated to compensate for the light distribution due to lens curvature.

Due to the lens roll off, the pixels in the edge and corner area receive much less light than the pixels in the center area, which makes the image darker in the edges and corner areas. The lens correction function amplifies pixel output based on the distance from the pixel to the lens optical center to achieve uniform image. [table 5-4](#) lists lens correction related registers, and [figure 5-2](#) shows the lens correction function of OV7675/OV7175.

**table 5-4** LENC related registers

address	register name	description
0x55	LCC5	Bit[2]: Lens correction control select 0: R, G, and B channel compensation coefficient is set by 0x64 1: R, G, and B channel compensation coefficient is set by registers and respectively Bit[0]: Lens correction enable 0: Disabled 1: Enabled
0x62	LCC1	Lens Correction Option 1 Bit[7]: Sign bit for X coordinate of lens correction center relative to array center 0: Coordinate is + 0x62[6:0] 1: Coordinate is - 0x62[6:0]
0x63	LCC2	Lens Correction Option 2 Bit[7]: Sign bit for Y coordinate of lens correction center relative to array center 0: Coordinate is + 0x63[6:0] 1: Coordinate is - 0x63[6:0]
0x65	LCC4	Radius of the circle, no compensation will be applied inside the circle
0x64	LCC3	G Channel Compensation Coefficient when LCC5[2] (0x66) is 1 R, G, and B Channel Compensation Coefficient when LCC5[2] (0x66) is 0
0x94	LCC6	B channel compensation coefficient (effective only when LCC5[2] is high)
0x95	LCC7	R channel compensation coefficient (effective only when LCC5[2] is high)

figure 5-2 lens correction function

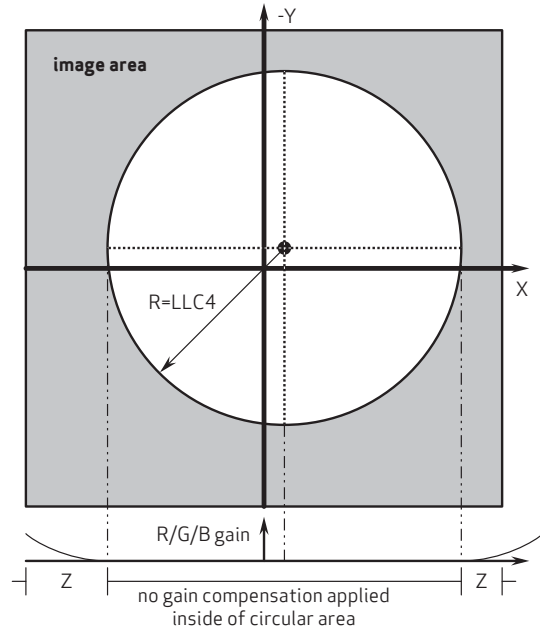

**note 1** R/G/B gain compensation is independently applied at Z (outside of the circular area) based on register LCC3, LCC6, and LCC7 respectively.

7675\_DS\_5\_2

## 6 image sensor output interface digital functions

### 6.1 digital video port (DVP)

#### 6.1.1 overview

The Digital Video Port (DVP) provides 8-bit parallel data output in all formats supported, and extended features including HSYNC mode and test pattern output.

#### 6.1.2 VGA timing diagram

**figure 6-1** VGA timing diagram

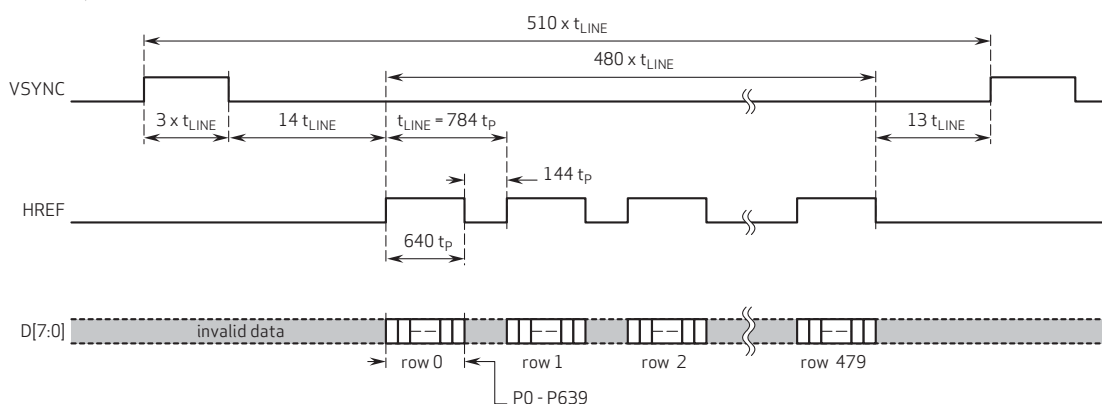

**note 1** for raw data,  $t_P = t_{PCLK}$

**note 2** for YUV/RGB,  $t_P = 2 \times t_{PCLK}$

7675\_DS\_6\_1

**figure 6-2** QVGA timing diagram

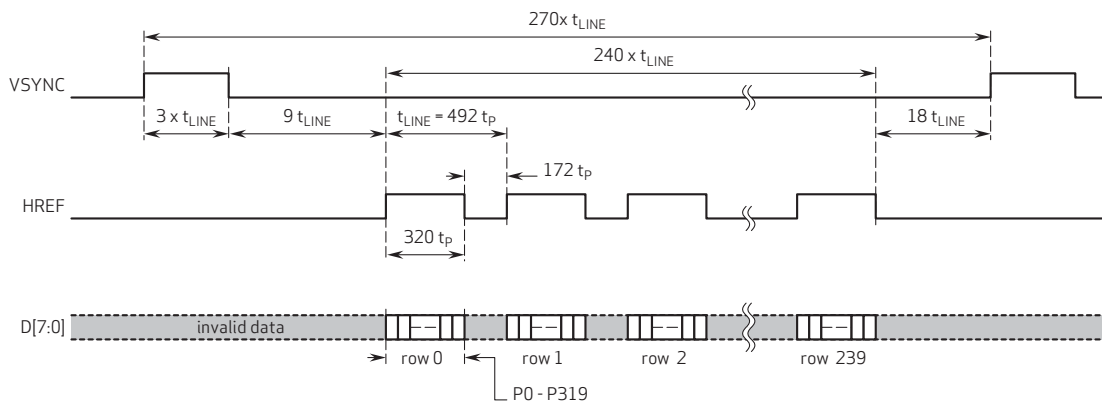

**note 1** for raw data,  $t_P = t_{PCLK}$

**note 2** for YUV/RGB,  $t_P = 2 \times t_{PCLK}$

7675\_DS\_6\_2

figure 6-3 QQVGA timing diagram

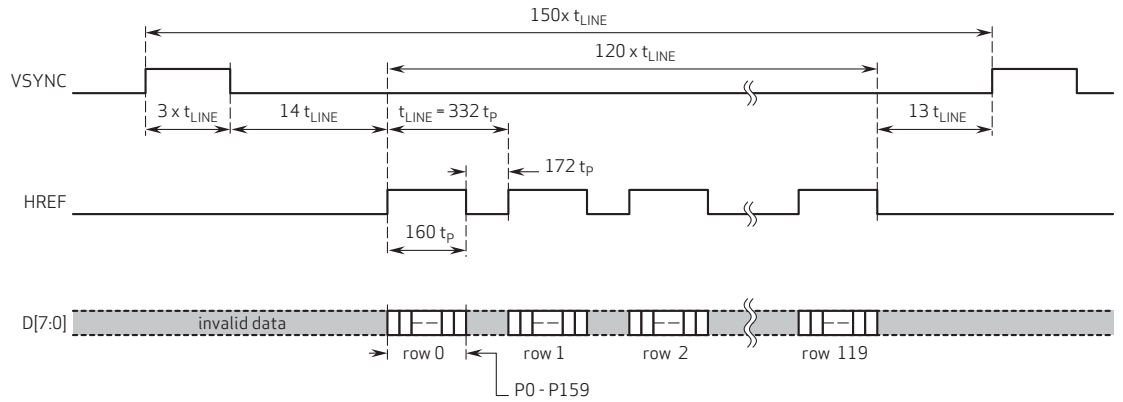

- note 1 for raw data,  $t_p = t_{pCLK}$
- note 2 for YUV/RGB,  $t_p = 2 \times t_{pCLK}$

7675\_DS\_6\_3

## 7 register tables

The following tables provide descriptions of the device control registers contained in the OV7675/OV7175. For all register enable/disable bits, enable = 1 and DISABLE = 0. The device slave addresses are 0x42 for write and 0x43 for read.

**table 7-1** system control registers (sheet 1 of 17)

address	register name	default value	R/W	description
0x00	GAIN	0x00	RW	AGC - Gain Control Gain Setting Bit[7:0]: AGC[7:0] (see <b>VREF</b> [7:6] (0x03) for AGC[9:8])  $\text{gain} = (0x03[7] + 1) \times (0x03[6] + 1) \times (0x00[7] + 1) \times (0x00[6] + 1) \times (0x00[5] + 1) \times (0x00[4] + 1) \times \left( \frac{0x00[3:0]}{16} + 1 \right)$
0x01	BLUE	0x80	RW	AWB – Blue Channel Gain Setting Blue Gain = BLUE[7:0] / 0x40, BLUE[7:0] ≥ 0x40
0x02	RED	0x80	RW	AWB – Red Channel Gain Setting Red Gain = RED[7:0] / 0x40, RED[7:0] ≥ 0x40
0x03	VREF	0x00	RW	Vertical Frame Control Bit[7:6]: AGC[9:8] (see <b>GAIN</b> [7:0] (0x00) for AGC[7:0]) Bit[5:4]: Debug mode Bit[3:2]: VREF end 2 LSBs (8 MSBs at <b>VSTART</b> [7:0] (0x19)) Bit[1:0]: VREF start 2 LSBs (8 MSBs at <b>VSTOP</b> [7:0] (0x1A))
0x04	COM1	0x00	RW	Common Control 1 Bit[7]: Debug mode Bit[6]: CCIR656 format 0: Disable 1: Enable Bit[5:2]: Debug mode Bit[1:0]: 2 LSBs (see registers <b>AECHH</b> [5:0] (0x07) and <b>AECH</b> [7:0] (0x10) for AEC[15:10] and AEC[9:2], respectively)
0x05	BAVE	0x00	RW	U/B Average Level Automatically updated based on chip output format
0x06	BGAVE	0x00	RW	Y/Gb Average Level Automatically updated based on chip output format
0x07	AECHH	0x00	RW	Exposure Value - AEC 5 MSBs Bit[7:6]: Not used Bit[5:0]: AEC[15:10] (see registers <b>AECH</b> [7:0] (0x10) and <b>COM1</b> [1:0] (0x04) for AEC[9:2] and AEC[1:0], respectively)

table 7-1 system control registers (sheet 2 of 17)

address	register name	default value	R/W	description
0x08	RAVE	0x00	RW	V/R Average Level Automatically updated based on chip output format
0x09	COM2	0x01	RW	Common Control 2 Bit[7:5]: Debug mode Bit[4]: Soft sleep mode 0: Disable 1: Enable Bit[3:2]: Debug mode Bit[1:0]: Output drive capability 00: 1x 01: 2x 10: 3x 11: 4x
0x0A	PID	0x76	R	Product ID Number MSB (Read only)
0x0B	VER	0x73	R	Product ID Number LSB (Read only)
0x0C	COM3	0x00	RW	Common Control 3 Bit[7]: Debug mode Bit[6]: Output data MSB and LSB swap Bit[5]: Tri-state option for output clock at power-down period 0: Tri-state at this period 1: No tri-state at this period Bit[4]: Tri-state option for output data at power-down period 0: Tri-state at this period 1: No tri-state at this period Bit[3:0]: Debug mode
0x0D	COM4	0x00	RW	Common Control 4 Bit[7:6]: Debug mode Bit[5:4]: Average option (must be same value as <b>COM17</b> [7:6] (0x42)) 00: Full window 01: 1/2 window 10: 1/4 window 11: 1/4 window Bit[3:0]: Debug mode
0x0E	DEBUG MODE	–	–	Debug Mode

table 7-1 system control registers (sheet 3 of 17)

address	register name	default value	R/W	description															
0x0F	COM6	0x43	RW	<p>Common Control 6</p> <p>Bit[7]: Output of optical black line option 0: Disable HREF at optical black 1: Enable HREF at optical black</p> <p>Bit[6:2]: Debug mode</p> <p>Bit[1]: Reset all timing when format changes 0: No reset 1: Resets timing</p> <p>Bit[0]: Debug mode</p>															
0x10	AECH	0x40	RW	<p>Exposure Value</p> <p>Bit[7:0]: AEC[9:2] (see registers <b>AECHH</b>[5:0] (0x07) and <b>COM1</b>[1:0] (0x04) for AEC[15:10] and AEC[1:0], respectively)</p>															
0x11	CLKRC	0x80	RW	<p>Internal Clock</p> <p>Bit[7]: Debug</p> <p>Bit[6]: Use external clock directly (no clock pre-scale available)</p> <p>Bit[5:0]: Internal clock pre-scalar <math>F(\text{internal clock}) = F(\text{input clock}) / (\text{Bit}[5:0] + 1)</math> Range: [0 0000] to [1 1111]</p>															
0x12	COM7	0x00	RW	<p>Common Control 7</p> <p>Bit[7]: SCCB register reset 0: No change 1: Resets all registers to default values</p> <p>Bit[6:5]: Debug mode</p> <p>Bit[4]: Output format QVGA selection</p> <p>Bit[3]: Debug mode</p> <p>Bit[2]: Output format RGB selection (see below bit[0])</p> <p>Bit[1]: Color bar 0: Disable 1: Enable</p> <p>Bit[0]: Output format Raw RGB (see below)</p> <table border="0" style="margin-left: auto; margin-right: auto;"> <thead> <tr> <th></th> <th>COM7[2]</th> <th>COM7[0]</th> </tr> </thead> <tbody> <tr> <td>YUV</td> <td>0</td> <td>0</td> </tr> <tr> <td>RGB</td> <td>1</td> <td>0</td> </tr> <tr> <td>Bayer RAW</td> <td>0</td> <td>1</td> </tr> <tr> <td>Processed Bayer RAW</td> <td>1</td> <td>1</td> </tr> </tbody> </table>		COM7[2]	COM7[0]	YUV	0	0	RGB	1	0	Bayer RAW	0	1	Processed Bayer RAW	1	1
	COM7[2]	COM7[0]																	
YUV	0	0																	
RGB	1	0																	
Bayer RAW	0	1																	
Processed Bayer RAW	1	1																	

table 7-1 system control registers (sheet 4 of 17)

address	register name	default value	R/W	description
0x13	COM8	0x8F	RW	<p>Common Control 8</p> <p>Bit[7]: Enable fast AGC/AEC algorithm</p> <p>Bit[6]: AEC - Step size option                      0: Step size is limited to vertical blank                      1: Unlimited step size</p> <p>Bit[5]: Banding filter ON/OFF                      In order to turn ON the banding filter, <b>BD50ST</b> (0x9D) or <b>BD60ST</b> (0x9E) must be set to a non-zero value                      0: OFF                      1: ON</p> <p>Bit[4]: Debug mode</p> <p>Bit[3]: Pixel level exposure ON/OFF selection                      1: Allow exposure time less than 1 line                      0: Limit the minimum exposure time to 1 line</p> <p>Bit[2]: AGC enable                      0: Disable                      1: Enable</p> <p>Bit[1]: AWB enable                      0: Disable                      1: Enable</p> <p>Bit[0]: AEC enable                      0: Disable                      1: Enable</p>
0x14	COM9	0x4A	RW	<p>Common Control 9</p> <p>Bit[7]: Debug mode</p> <p>Bit[6:4]: Automatic gain ceiling                      Maximum AGC value                      000: 2x                      001: 4x                      010: 8x                      011: 16x                      100: 32x                      101: 64x                      110: 128x                      111: Debug mode</p> <p>Bit[3:1]: Debug mode</p> <p>Bit[0]: Freeze AGC/AEC</p>



table 7-1 system control registers (sheet 5 of 17)

address	register name	default value	R/W	description
				Common Control 10 Bit[7]: Debug mode Bit[6]: HREF changes to HSYNC Bit[5]: PCLK output option 0: Free running PCLK 1: PCLK does not toggle during horizontal blank Bit[4]: PCLK reverse Bit[3]: HREF reverse Bit[2]: VSYNC option 0: VSYNC changes on falling edge of PCLK 1: VSYNC changes on rising edge of PCLK Bit[1]: VSYNC negative Bit[0]: HSYNC negative
0x15	COM10	0x00	RW	
0x16	NOT USED	–	–	Not Used
0x17	HSTART	0x11	RW	Output Format - Horizontal Frame (HREF column) start 8 MSBs (3 LSBs are at <b>HREF</b> [2:0] (0x32))
0x18	HSTOP	0x61	RW	Output Format - Horizontal Frame (HREF column) end 8 MSBs (3 LSBs are at <b>HREF</b> [5:3] (0x32))
0x19	VSTART	0x03	RW	Output Format - Vertical Frame (row) start 8 MSBs (2 LSBs are at <b>VREF</b> [1:0] (0x03))
0x1A	VSTOP	0x7B	RW	Output Format - Vertical Frame (row) end 8 MSBs (2 LSBs are at <b>VREF</b> [3:2] (0x03))
0x1B	PSHFT	0x00	RW	Data Format - Pixel Delay Select (delays timing of the D[7:0] data relative to HREF in pixel units) Range: [00] (no delay) to [FF] (256 pixel delay which accounts for whole array)
0x1C	MIDH	0x7F	R	Manufacturer ID High Byte
0x1D	MIDL	0xA2	R	Manufacturer ID Low Byte
				Mirror/VFlip Enable Bit[7:6]: Debug mode Bit[5]: Mirror 0: Normal image 1: Mirror image Bit[4]: VFlip enable 0: Normal image 1: Vertically flip image Bit[3:0]: Debug mode
0x1E	MVFP	0x01	RW	
0x1F	DEBUG MODE	–	–	Debug Mode

table 7-1 system control registers (sheet 6 of 17)

address	register name	default value	R/W	description
0x20~0x23	NOT USED	–	–	Not Used
0x24	AEW	0x62	RW	AGC/AEC - Stable Operating Region (Upper Limit)
0x25	AEB	0x58	RW	AGC/AEC - Stable Operating Region (Lower Limit)
0x26	VPT	0x93	RW	AGC/AEC Fast Mode Operating Region Bit[7:4]: High nibble of upper limit of fast mode control zone Bit[3:0]: High nibble of lower limit of fast mode control zone
0x27~0x29	NOT USED	–	–	Not Used
0x2A	EXHCH	0x00	RW	Dummy Pixel Insert Bit[7:4]: Dummy pixel insert in horizontal direction[11:8] (2 MSBs in <b>REGCA</b> [7:6] (0xCA), 8 LSBs in <b>EXHCL</b> (0x2B)) Bit[3:2]: HSYNC falling edge delay 2 MSBs (see <b>HSYEN</b> [7:0] (0x31) for 8 LSBs) Bit[1:0]: HSYNC rising edge delay 2 MSBs (see <b>HSYST</b> [7:0] (0x30) for 8 LSBs)
0x2B	EXHCL	0x00	RW	Bit[7:0]: Dummy pixel insert in horizontal direction[7:0] (see <b>REGCA</b> [7:6] (0xCA) and <b>EXHCH</b> [7:4] (0x2A))
0x2C	NOT USED	–	–	Not Used
0x2D	ADVFL	0x00	RW	LSBs of Insert Dummy Lines in Vertical Direction (1 bit equals 1 line)
0x2E	ADV FH	0x00	RW	MSBs of Insert Dummy Lines in Vertical Direction
0x2F	YAVE	0x00	RW	Y/G Channel Average Value
0x30	HSYST	0x08	RW	HSYNC Rising Edge Delay 8 LSBs (see <b>EXHCH</b> [1:0] (0x2A) for 2 MSBs)
0x31	HSYEN	0x30	RW	HSYNC Falling Edge Delay (see <b>EXHCH</b> [3:2] (0x2A) for 8 MSBs)
0x32	HREF	0x80	RW	HREF Control Bit[7:6]: HREF edge offset to data output Bit[5:3]: HREF end 3 LSBs (8 MSBs at <b>HSTOP</b> (0x18)) Bit[2:0]: HREF start 3 LSBs (8 MSBs at <b>HSTART</b> (0x17))

table 7-1 system control registers (sheet 7 of 17)

address	register name	default value	R/W	description
0x33~ 0x39	NOT USED	–	–	Not Used
0x3A	TSLB	0x0D	RW	<p>Line Buffer Test Option</p> <p>Bit[7:6]: Debug mode</p> <p>Bit[5]: Negative image enable 0: Normal image 1: Negative image</p> <p>Bit[4]: UV output value 0: Use normal UV output 1: Use fixed UV value set in <b>MANU</b> (0x67) and <b>MANV</b> (0x68) as UV output instead of chip output</p> <p>Bit[3]: Output sequence (use with register <b>COM13</b>[0] (0x3D)) {TSLB[3], <b>COM13</b>[0]}: 00: Y U Y V 01: Y V Y U 10: U Y V Y 11: V Y U Y</p> <p>Bit[2:1]: Debug mode</p> <p>Bit[0]: Auto output window 0: Sensor DOES NOT automatically set window after resolution change. The companion backend processor can adjust the output window immediately after changing the resolution 1: Sensor automatically sets output window when resolution changes. After resolution changes, the companion backend processor must adjust the output window after the next VSYNC pulse.</p>

table 7-1 system control registers (sheet 8 of 17)

address	register name	default value	R/W	description
				Common Control 11
				Bit[7]: Night mode 0: Night mode disable 1: Night mode enable The frame rate is reduced automatically while the minimum frame rate is limited by {REFCF[3], COM11[6:5]}. Also, ADVFH(0x2E) and ADVFL(0x2D) will be automatically updated.
0x3B	COM11	0x00	RW	Bit[6:5]: RAF[1:0] Minimum frame rate of night mode (MSB in REFCF[3] (0xCF)) {REFCF[3], COM11[6:5]}: 000: Same as normal mode frame rate 001: 1/2 of normal mode frame rate 010: 1/3 of normal mode frame rate 011: 1/4 of normal mode frame rate 1xx: 1/8 of normal mode frame rate Bit[4]: Debug mode Bit[3]: Banding filter value select (effective only when COM11[4] = 0) 0: Select BD60ST[9:0] (0xE1[3:2], 0x9E[7:0]) as banding filter value 1: Select BD50ST[9:0] (0xE1[1:0], 0x9D[7:0]) as banding filter value Bit[2]: Debug mode Bit[1]: Exposure timing can be less than limit of banding filter when light is too strong Bit[0]: Debug mode
				Common Control 12
0x3C	COM12	0x68	RW	Bit[7]: HREF option 0: No HREF when VSYNC is low 1: Always has HREF Bit[6:0]: Debug mode
				Common Control 13
0x3D	COM13	0x88	RW	Bit[7]: Gamma enable Bit[6]: UV saturation level UV auto adjustment. Result is saved in register SATCTR[3:0] (0xC9) Bit[5:1]: Reserved Bit[0]: UV swap (use with register TSLB[3] (0x3A)) {TSLB[3], COM13[0]}: 00: Y U Y V 01: Y V Y U 10: U Y V Y 11: V Y U Y

table 7-1 system control registers (sheet 9 of 17)

address	register name	default value	R/W	description
0x3E	COM14	0x00	RW	<p>Common Control 14</p> <p>Bit[7:5]: Debug mode</p> <p>Bit[4]: DCW and scaling PCLK enable</p> <p>0: Normal PCLK</p> <p>1: PCLK controlled by register COM14[2:0]</p> <p>Bit[3]: Debug mode</p> <p>Bit[2:0]: PCLK divider (only when COM14[4] = 1)</p> <p>000: Divided by 1</p> <p>001: Divided by 2</p> <p>010: Divided by 4</p> <p>011: Divided by 8</p> <p>100: Divided by 16</p> <p>101~111: Debug mode</p>
0x3F	EDGE	0x00	RW	<p>Edge Enhancement Adjustment</p> <p>Bit[7:5]: Debug mode</p> <p>Bit[4:0]: Edge enhancement factor</p>
0x40	COM15	0xC0	RW	<p>Common Control 15</p> <p>Bit[7:6]: Data format</p> <p>Output full range enable</p> <p>0x: Output range: [10] to [F0]</p> <p>10: Output range: [01] to [FE]</p> <p>11: Output range: [00] to [FF]</p> <p>Bit[5:4]: RGB555/565 option (must set COM7[2] = 1 and COM7[0] = 0)</p> <p>x0: Normal RGB output</p> <p>01: RGB565, effective only when REG444[1] (0x8C) is low</p> <p>11: RGB555, effective only when REG444[1] (0x8C) is low</p> <p>Bit[3:0]: Debug mode</p>

table 7-1 system control registers (sheet 10 of 17)

address	register name	default value	R/W	description
				Common Control 16 Bit[7:6]: Debug mode Bit[5]: Enable edge enhancement threshold auto-adjustment for YUV output (result is saved in register <b>EDGE</b> [4:0] (0x3F) and range is controlled by registers <b>REG75</b> REG75[4:0] (0x75) and <b>REG76</b> [4:0] (0x76)) 0: Disable 1: Enable Bit[4]: De-noise threshold auto-adjustment (result is saved in register <b>DNSTH</b> (0x4C) and range is controlled by <b>REG77</b> [7:0] (0x77)) 0: Disable 1: Enable Bit[3]: AWB gain enable Bit[2]: Reserved Bit[1]: Color matrix coefficient double option 0: Original matrix 1: Double of original matrix Bit[0]: Debug mode
0x41	COM16	0x38	RW	
				Common Control 17 Bit[7:6]: AEC window (must be the same value as <b>COM4</b> [5:4] (0x0D)) 00: Normal 01: 1/2 10: 1/4 11: 1/4 Bit[5:4]: Debug mode Bit[3]: DSP color bar enable 0: Disable 1: Enable Bit[2:0]: Debug mode
0x42	COM17	0x00	RW	
0x43~ 0x4B	DEBUG MODE	–	–	Debug Mode
0x4C	DNSTH	0x00	RW	De-noise Strength
0x4D~ 0x4E	DEBUG MODE	–	–	Debug Mode
0x4F	MTX1	0x96	RW	Matrix Coefficient 1
0x50	MTX2	0x9B	RW	Matrix Coefficient 2
0x51	MTX3	0x05	RW	Matrix Coefficient 3
0x52	MTX4	0x1A	RW	Matrix Coefficient 4
0x53	MTX5	0x7F	RW	Matrix Coefficient 5

table 7-1 system control registers (sheet 11 of 17)

address	register name	default value	R/W	description
0x54	MTX6	0x54	RW	Matrix Coefficient 6
0x55	BRIGHT	0x00	RW	Brightness Control
0x56	CONTRAS	0x40	RW	Contrast Control
0x57	CONTRAS CENTER	0x80	RW	Contrast Center
				Bit[7]: Auto contrast center enable 0: Disable, center is set by register <b>CONTRAS CENTER</b> (0x57) 1: Enable, register <b>CONTRAS CENTER</b> is updated automatically
0x58	MTXS	0x1A	RW	Bit[6]: Debug mode Bit[5]: Sign bit for <b>MTX6</b> (0x54) Bit[4]: Sign bit for <b>MTX5</b> (0x53) Bit[3]: Sign bit for <b>MTX4</b> (0x52) Bit[2]: Sign bit for <b>MTX3</b> (0x51) Bit[1]: Sign bit for <b>MTX2</b> (0x50) Bit[0]: Sign bit for <b>MTX1</b> (0x4F)
0x59~ 0x61	DEBUG MODE	–	–	Debug Mode
0x62	LCC1	0x00	RW	Lens Correction Option 1 Bit[7]: Sign bit for X coordinate of lens correction center relative to array center 0: Coordinate is positive 1: Coordinate is negative Bit[6:0]: X coordinate of lens correction center relative to array center
0x63	LCC2	0x00	RW	Lens Correction Option 2 Bit[7]: Sign bit for Y coordinate of lens correction center relative to array center 0: Coordinate is positive 1: Coordinate is negative Bit[6:0]: Y coordinate of lens correction center relative to array center
0x64	LCC3	0x50	RW	Lens Correction Option 3 Bit[2]: When <b>LCC5</b> [2] (0x66) is 1, this is the G channel compensation coefficient When <b>LCC5</b> [2] (0x66) is 0, this is the R, G and B channel compensation coefficient
0x65	LCC4	0x30	RW	Lens Correction Option 4 - Radius of the circular section where no compensation applies

table 7-1 system control registers (sheet 12 of 17)

address	register name	default value	R/W	description
0x66	LCC5	0x00	RW	Lens Correction Control 5 Bit[7:3]: Not used Bit[2]: Lens correction control select 0: R, G, and B channel compensation coefficient is set by register <b>LCC3</b> (0x64) 1: R, G, and B channel compensation coefficient is set by <b>LCC7</b> (0x95), <b>LCC5[2]</b> (0x64), and <b>LCC6</b> (0x94), respectively Bit[1]: Not used Bit[0]: Lens correction enable 0: Disable 1: Enable
0x67	MANU	0x80	RW	Manual U Value (effective only when register <b>TSLB[4]</b> (0x3A))
0x68	MANV	0x80	RW	Manual V Value (effective only when register <b>TSLB[4]</b> (0x3A))
0x69	GFIX	0x00	RW	Fixed Gain Control Bit[7:6]: Fixed gain for Gr channel 00: 1x 01: 1.25x 10: 1.5x 11: 1.75x Bit[5:4]: Fixed gain for Gb channel 00: 1x 01: 1.25x 10: 1.5x 11: 1.75x Bit[3:2]: Fixed gain for R channel 00: 1x 01: 1.25x 10: 1.5x 11: 1.75x Bit[1:0]: Fixed gain for B channel 00: 1x 01: 1.25x 10: 1.5x 11: 1.75x
0x6A	GREEN	0x40	RW	AWB – Green Channel Gain Setting Green Gain = GREEN[7:0] / 0x40, GREEN[7:0] ≥ 0x40



table 7-1 system control registers (sheet 13 of 17)

address	register name	default value	R/W	description
0x6B	DBLV	0x0A	RW	Bit[7:6]: PLL control 00: Bypass PLL 01: Input clock x4 10: Input clock x6 11: Input clock x8 Bit[5:0]: Debug mode
0x6C	AWBCTR3	0x0A	RW	AWB Control 3
0x6D	AWBCTR2	0x65	RW	AWB Control 2
0x6E	AWBCTR1	0x11	RW	AWB Control 1
0x6F	AWBCTR0	0x9F	RW	AWB Control 0
0x70	SCALING_XSC	0x3A	RW	Bit[7]: Test_pattern[0] Works with test_pattern[1] { <b>SCALING_YSC</b> [7], <b>SCALING_XSC</b> [7]} 00: No test output 01: Shifting "1" 10: 8-bar color bar 11: Not valid Bit[6:0]: Not used
0x71	SCALING_YSC	0x35	RW	Bit[7]: Test_pattern[1] Works with test_pattern[0] { <b>SCALING_YSC</b> [7], <b>SCALING_XSC</b> [7]} Bit[6:0]: Not used
0x72~ 0x73	DEBUG MODE	–	–	Debug Mode
0x74	REG74	0x00	RW	Bit[7:5]: Debug mode Bit[4]: DG_Manu 0: Digital gain control by <b>VREF</b> [7:6] (0x03) 1: Digital gain control by <b>REG74</b> [1:0] (0x74) Bit[3:2]: Debug mode Bit[1:0]: Digital gain manual control 00: Bypass 01: 1x
0x75	REG75	0x0F	RW	Bit[7:5]: Not used Bit[4:0]: Edge enhancement lower limit

table 7-1 system control registers (sheet 14 of 17)

address	register name	default value	R/W	description
0x76	REG76	0x01	RW	Bit[7]: Black pixel correction enable 0: Disable 1: Enable Bit[6]: White pixel correction enable 0: Disable 1: Enable Bit[5]: Not used Bit[4:0]: Edge enhancement higher limit
0x77	REG77	0x10	RW	Bit[7:0]: De-noise offset
0x78~ 0x79	DEBUG MODE	–	–	Debug Mode
0x7A	SLOP	0x28	RW	Gamma Curve Highest Segment Slope Calculated as follows: SLOP[7:0] = (0x100 - GAM15[7:0]) x 4/3
0x7B	GAM1	0x04	RW	Gamma Curve 1st Segment Input End Point 0x04 Output Value
0x7C	GAM2	0x09	RW	Gamma Curve 2nd Segment Input End Point 0x08 Output Value
0x7D	GAM3	0x16	RW	Gamma Curve 3rd Segment Input End Point 0x10 Output Value
0x7E	GAM4	0x30	RW	Gamma Curve 4th Segment Input End Point 0x20 Output Value
0x7F	GAM5	0x3E	RW	Gamma Curve 5th Segment Input End Point 0x28 Output Value
0x80	GAM6	0x4B	RW	Gamma Curve 6th Segment Input End Point 0x30 Output Value
0x81	GAM7	0x59	RW	Gamma Curve 7th Segment Input End Point 0x38 Output Value
0x82	GAM8	0x67	RW	Gamma Curve 8th Segment Input End Point 0x40 Output Value
0x83	GAM9	0x72	RW	Gamma Curve 9th Segment Input End Point 0x48 Output Value
0x84	GAM10	0x7C	RW	Gamma Curve 10th Segment Input End Point 0x50 Output Value
0x85	GAM11	0x8E	RW	Gamma Curve 11th Segment Input End Point 0x60 Output Value
0x86	GAM12	0x9E	RW	Gamma Curve 12th Segment Input End Point 0x70 Output Value

table 7-1 system control registers (sheet 15 of 17)

address	register name	default value	R/W	description
0x87	GAM13	0xB6	RW	Gamma Curve 13th Segment Input End Point 0x90 Output Value
0x88	GAM14	0xCC	RW	Gamma Curve 14th Segment Input End Point 0xB0 Output Value
0x89	GAM15	0xE2	RW	Gamma Curve 15th Segment Input End Point 0xD0 Output Value
0x8A~ 0x8B	DEBUG MODE	–	–	Debug Mode
0x8C	REG444	0x00	RW	Bit[7:2]: Not used Bit[1]: RGB444 enable (effective only when <b>COM15</b> [4] (0x40) is high) 0: Disable 1: Enable Bit[0]: RGB444 word format 0: xR GB 1: RG Bx
0x8D~ 0x91	DEBUG MODE	–	–	Debug Mode
0x92	DM_LNH	0x00	RW	Dummy Line 8 LSBs
0x93	LCC6	0x50	RW	Dummy Line 8 MSBs
0x94	LCC7	0x50	RW	Lens Correction Option 6 (effective only when <b>LCC5</b> [2] (0x66) is high)
0x95	RSVD	XX	–	Lens Correction Option 7 (effective only when <b>LCC5</b> [2] (0x66) is high)
0x96~ 0x9C	DEBUG MODE	–	–	Debug Mode
0x9D	BD50ST	0x7F	RW	50 Hz Banding Filter Value, LSBs (effective only when <b>COM8</b> [5] (0x13) is high and <b>COM11</b> [3] (0x3B) is high)
0x9E	BD60ST	0xC0	RW	60 Hz Banding Filter Value, LSBs (effective only when <b>COM8</b> [5] (0x13) is high and <b>COM11</b> [3] (0x3B) is low)
0x9F~ 0xA3	DEBUG MODE	–	–	Debug Mode

table 7-1 system control registers (sheet 16 of 17)

address	register name	default value	R/W	description
0xA4	NT_CTRL	0x00	RW	Bit[7:4]: Not used Bit[3]: Auto frame rate adjustment control 0: Double exposure time 1: Reduce frame rate by half Bit[2]: Not used Bit[1:0]: Auto frame rate adjustment switch point 00: Insert dummy row at 2x gain 01: Insert dummy row at 4x gain 10: Insert dummy row at 8x gain
0xA5	BD50MAX	0x0F	RW	50Hz Banding Step Limit
0xA6 – 0xAA	DEBUG MODE	–	–	Debug Mode
0xAB	BD60MAX	0x0F	RW	60Hz Banding Step Limit
0xAC – 0xC8	DEBUG MODE	–	–	Debug Mode
0xC9	SATCTR	0xC0	RW	Saturation Control Bit[7:4]: UV saturation control min Bit[3:0]: UV saturation control result
0xCA	REGCA	0x00	RW	Bit[7:6]: Dummy pixel insert in horizontal direction[13:12] (see <b>EXHCH</b> [7:4] (0x2A) and <b>EXHCL</b> [7:0] (0x2B)) Bit[7:6]: Debug mode
0xCB – 0xCE	NOT USED	–	–	Not used
0xCF	REFCF	0x84	RW	Bit[7:4]: Debug mode Bit[3]: RAF[2] (used together with <b>COM11</b> [6:5] (0x3B)) Bit[2:0]: Debug mode
0xD0~ 0xD3	DEBUG MODE	–	–	Debug Mode
0xD4	RADCO	0x84	RW	ADC Control Bit[7:3]: Debug mode Bit[2:0]: ADC referenced adjustment 000: 0.8x 100: 1x 111: 1.2x
0xD5~ 0xDB	DEBUG MODE	–	–	Debug Mode
0xDC	RPWC2	0x35	RW	Bit[7:4]: Debug mode Bit[3]: Regulator control 0: Enable internal regulator 1: Bypass internal regulator

table 7-1 system control registers (sheet 17 of 17)

address	register name	default value	R/W	description
0xDD~ 0xE0	DEBUG MODE	–	–	Debug Mode
0xE1	REGE1	0x40	RW	Bit[7:4]: Debug mode Bit[3:2]: BD60st[9:8] 60 Hz banding filter value 2 MSBs (8 LSBs are at <b>BD60ST</b> (0x9E)) Bit[1:0]: BD50st[9:8] 50 Hz banding filter value 2 MSBs (8 LSBs are at <b>BD50ST</b> (0x9D))
0xE2~ 0xE7	DEBUG MODE	–	–	Debug Mode
0xE8	RDSP0	0x15	RW	Bit[7:1]: Debug mode Bit[0]: LCD gain adjustment enable
0xE9	DEBUG MODE	–	–	Debug Mode
0xEA	RDSP2	0x10	RW	Bit[7:6]: Debug mode Bit[5:4]: LCD gain of red channel 00: Not allowed 01: 1x gain 10: 2x gain 11: Not allowed Bit[3:0]: Fractional LCD gain of red channel 1/16 gain for each step increment
0xEB	RDSP3	0x10	RW	Bit[7:6]: Debug mode Bit[5:4]: LCD gain of green channel 00: Not allowed 01: 1x gain 10: 2x gain 11: Not allowed Bit[3:0]: Fractional LCD gain of green channel 1/16 gain for each step increment
0xEC	RDSP4	0x10	RW	Bit[7:6]: Debug mode Bit[5:4]: LCD gain of blue channel 00: Not allowed 01: 1x gain 10: 2x gain 11: Not allowed Bit[3:0]: Fractional LCD gain of blue channel 1/16 gain for each step increment
0xED~ 0xFF	DEBUG MODE	–	–	Debug Mode



## 8 operating specifications

### 8.1 absolute maximum ratings

**table 8-1** absolute maximum ratings

parameter		absolute maximum rating <sup>a</sup>
ambient storage temperature		-40°C to +95°C
supply voltage (with respect to ground)	V <sub>DD-A</sub>	4.5V
	V <sub>DD-IO</sub>	4.5V
electro-static discharge (ESD)	human body model	2000V
	machine model	200V
all input/output voltages (with respect to ground)		-0.3V to V <sub>DD-IO</sub> + 1V
I/O current on any input or output pin		± 200 mA
peak solder temperature (10 second dwell time)		245°C

- a. exceeding the absolute maximum ratings shown above invalidates all AC and DC electrical specifications and may result in permanent damage to the device. Exposure to absolute maximum rated conditions for extended periods may affect device reliability.

### 8.2 functional temperature

**table 8-2** functional temperature

parameter	range
operating temperature range <sup>a</sup>	-30°C to +70°C
stable image temperature range <sup>b</sup>	0°C to 50°C

- a. sensor functions but image quality may be noticeably different at temperatures outside of stable image range  
 b. image quality remains stable throughout this temperature range

### 8.3 DC characteristics

**table 8-3** DC characteristics ( $-30^{\circ}\text{C} < T_A < 70^{\circ}\text{C}$ )

symbol	parameter	min	typ	max	unit
supply					
$V_{DD-A}$	supply voltage (analog)	2.6	2.8	3.0	V
$V_{DD-IO}$	supply voltage (digital I/O)	1.71	2.8	3.0	V
$I_{DD-A}$	active (operating) current		13	20	mA
$I_{DD-IO}$			22	30	mA
$I_{DDS-SCCB}$	standby current		1	2	mA
$I_{DDS-PWDN}$			20	50	$\mu\text{A}$
digital inputs (typical conditions: AVDD = 2.8V, DOVDD = 2.8V)					
$V_{IL}$	input voltage LOW			0.84	V
$V_{IH}$	input voltage HIGH	1.96			V
$C_{IN}$	input capacitor			10	pF
digital outputs (standard loading 25 pF)					
$V_{OH}$	output voltage HIGH	2.52			V
$V_{OL}$	output voltage LOW			0.28	V
serial interface inputs					
$V_{IL}^a$	SCL and SDA	-0.5	0	0.84	V
$V_{IH}^a$	SCL and SDA	1.96	2.8	3.3	V

a. based on DOVDD = 2.8 V



## 8.4 AC characteristics

**table 8-4** AC characteristics ( $T_A = 25^\circ\text{C}$ ,  $V_{DD-A} = 2.8\text{V}$ ,  $V_{DD-IO} = 2.8\text{V}$ )

symbol	parameter	min	typ	max	unit
ADC parameters					
B	analog bandwidth		12		MHz
DLE	DC differential linearity error		0.5		LSB
ILE	DC integral linearity error		1		LSB
	setting time for hardware reset			<1	ms
	setting time for software reset			<1	ms
	setting time for resolution mode change			<1	ms
	setting time for register setting			<300	ms

**table 8-5** timing characteristics

symbol	parameter	min	typ	max	unit
oscillator and clock input					
$f_{\text{osc}}$	frequency (XVCLK)	1.5 <sup>a</sup>	24	27	MHz
$t_r$ , $t_f$	clock input rise/fall time			5 (10 <sup>b</sup> )	ns

- a. below 6 MHz, PLL should be by-passed  
 b. if using the internal PLL



## 9 mechanical specifications

### 9.1 physical specifications

figure 9-1 package specifications

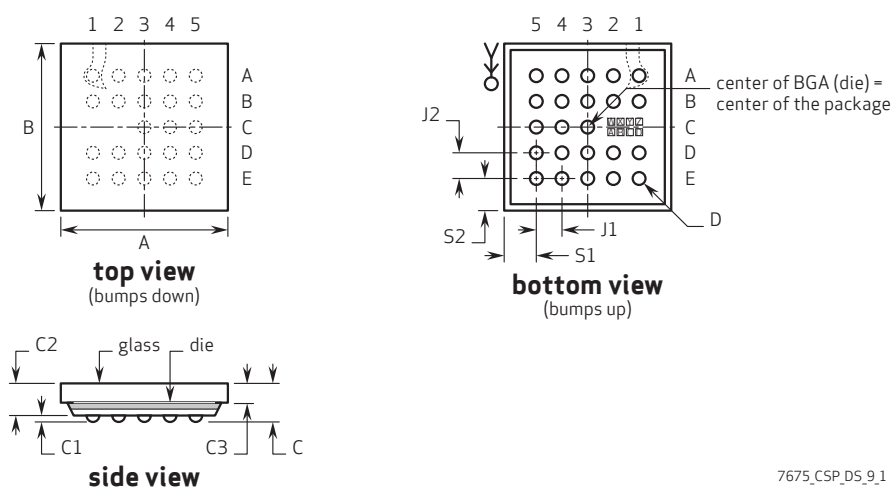
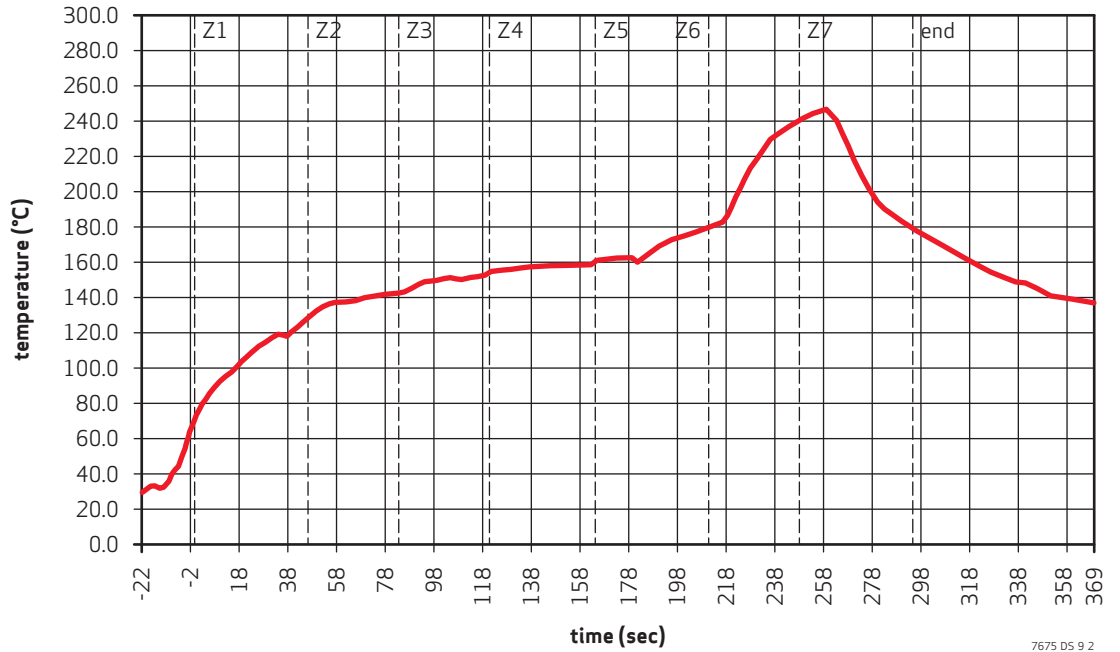

table 9-1 package dimensions

parameter	symbol	min	typ	max	unit
package body dimension x	A	2790	2815	2840	$\mu\text{m}$
package body dimension y	B	2800	2825	250	$\mu\text{m}$
package height	C	690	750	810	$\mu\text{m}$
ball height	C1	100	130	160	$\mu\text{m}$
package body thickness	C2	575	620	665	$\mu\text{m}$
thickness of glass surface to wafer	C3	425	445	465	$\mu\text{m}$
ball diameter	D	220	250	280	$\mu\text{m}$
total pin count	N		23 (2 NC)		
pin count x-axis	N1		5		
pin count y-axis	N2		5		
pins pitch x-axis	J1		500		$\mu\text{m}$
pins pitch y-axis	J2		500		$\mu\text{m}$
edge-to-pin center distance analog x	S1		408	438	$\mu\text{m}$
edge-to-pin center distance analog y	S2		413	443	$\mu\text{m}$

## 9.2 IR reflow specifications

figure 9-2 IR reflow ramp rate requirements



7675 DS 9 2

table 9-2 reflow conditions

condition	exposure
average ramp-up rate (30°C to 217°C)	less than 3°C per second
> 100°C	between 330 - 600 seconds
> 150°C	at least 210 seconds
> 217°C	at least 30 seconds (30 ~ 120 seconds)
peak temperature	245°C
cool-down rate (peak to 50°C)	less than 6°C per second
time from 30°C to 245°C	no greater than 390 seconds



**note**

The OV7675 uses a lead free package.

## 10 optical specifications

### 10.1 sensor array center

figure 10-1 sensor array center

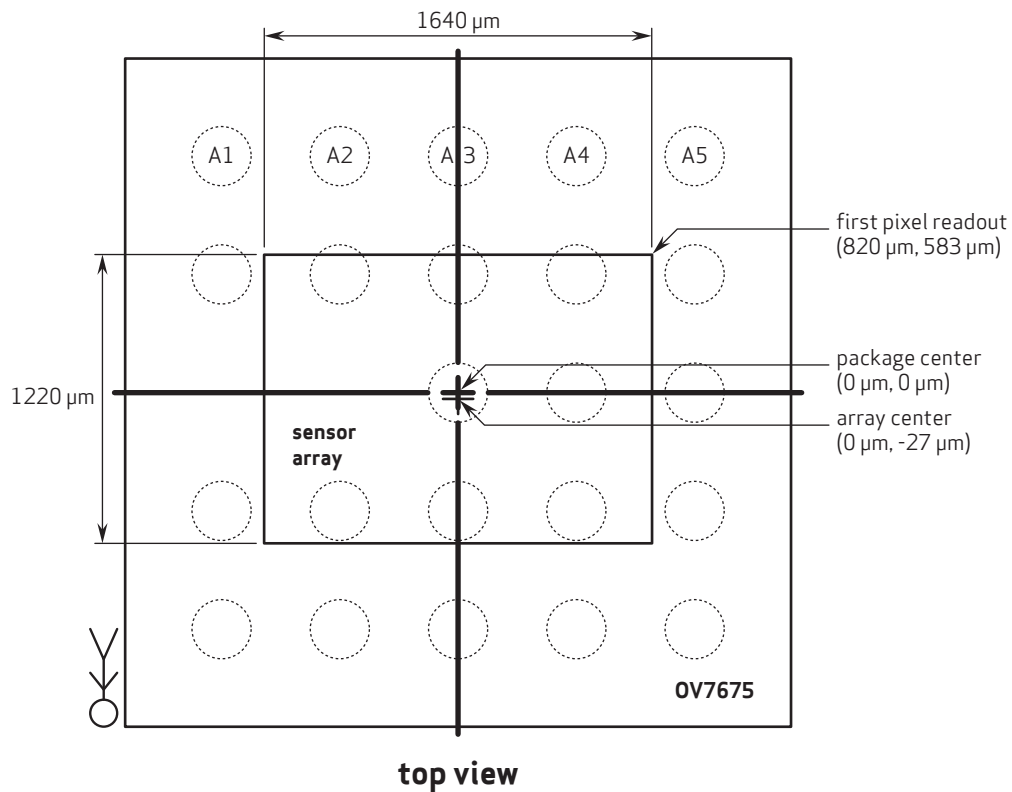

**note 1** this drawing is not to scale and is for reference only.

**note 2** as most optical assemblies invert and mirror the image, the chip is typically mounted with pin A1 to A5 oriented down on the PCB.

7675\_CSP\_DS\_10\_1

## 10.2 lens chief ray angle (CRA)

figure 10-2 chief ray angle (CRA)

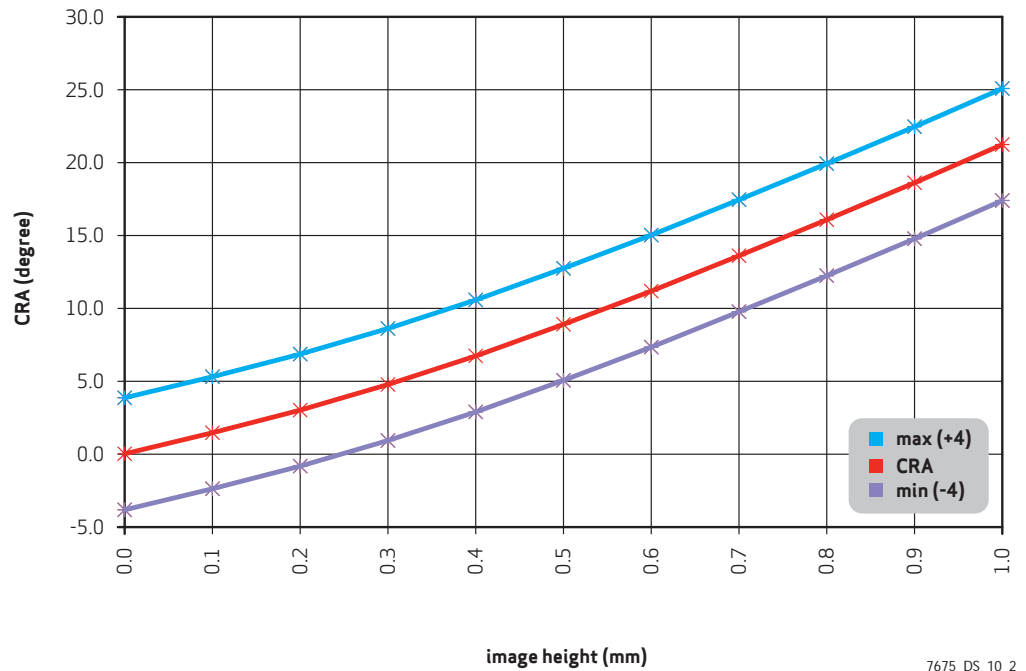

table 10-1 CRA versus image height plot

field (%)	image height (mm)	CRA (degrees)	maximum +4	minimum -4
0	0	0	4	-4
0.1	0.1	1.4117	5.4117	-2.5883
0.2	0.2	2.9752	6.9752	-1.0248
0.3	0.3	4.7348	8.7348	0.7348
0.4	0.4	6.6999	10.6999	2.6999
0.5	0.5	8.8546	12.8546	4.8546
0.6	0.6	11.1558	15.1558	7.1558
0.7	0.7	13.5627	17.5627	9.5627
0.8	0.8	16.0498	20.0498	12.0498
0.9	0.9	18.601	22.601	14.601
1.0	1.0	21.2001	25.2001	17.2001

## revision history

**version 1.0**            **05.14.2009**

- initial release

**version 2.0**            **10.13.2009**

- changed preliminary specification to product specification
- in the key specifications section made changes to: power requirements, sensitivity, S/N ration, dynamic range, maximum exposure interval, dark current, well capacity and fixed pattern noise
- in chapter 7, updated the default value for registers 0x24, 0x25, 0x26, 0x41, 0x4F, 0x50, 0x51, 0x52, 0x53, 0x54, 0x58, 0x6A, 0x6C, 0x6D, 0x6E, 0x6F, 0x7A~0x89, 0xCF
- in chapter 8, updated the TBD values in table 8-2
- in chapter 8, removed figure 8-1 and table 8-5







the clear advantage™

## OmniVision Technologies, Inc.

### UNITED STATES

4275 Burton Drive  
Santa Clara, CA 95054

tel: +1 408 567 3000

fax: +1 408 567 3001

email: [salesamerican@ovt.com](mailto:salesamerican@ovt.com)

### UNITED KINGDOM

Hampshire +44 1256 744 610

### FINLAND

Mouhijärvi +358 3 341 1898

### GERMANY

Munich +49 89 63 81 99 88

### CHINA

Beijing +86 10 6580 1690

Shanghai +86 21 6105 5100

Shenzhen +86 755 8384 9733

Hong Kong +852 2403 4011

### JAPAN

Tokyo +81 3 5765 6321

### KOREA

Seoul +82 2 3478 2812

### SINGAPORE +65 6562 8250

### TAIWAN

Taipei +886 2 2657 9800 -  
ext.#100