

Product Overview

The QPL1818 is a GaAs pHEMT single ended MMIC RF amplifier IC featuring 15dB of gain and low noise. This IC is designed to support DOCSIS 4.0 Amplifiers and Nodes as well as Fiber to The Home (FTTH), Satellite, Terrestrial TV, Home Gateways, and Cable Modems applications from 50 to 1800MHz. The QPL1818 is powered by a single 5 V supply and packaged in a 3 x 3 16-pin QFN.

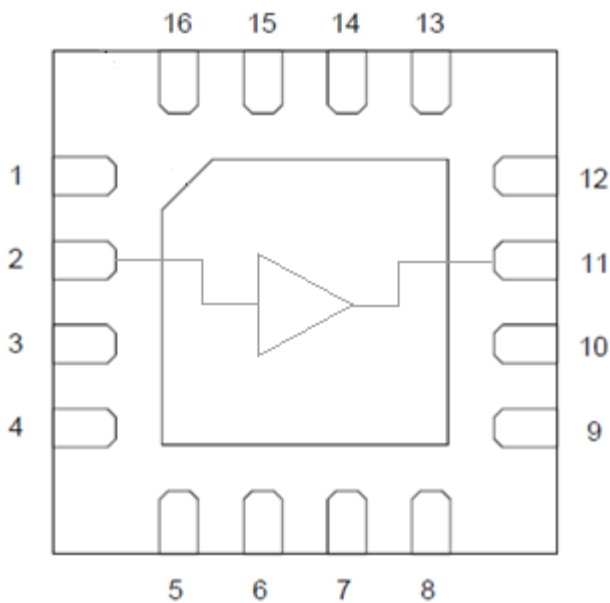

Functional Block Diagram



3 x 3 16-pin QFN Package

Key Features

- 50 MHz to 1800 MHz Operation
- 5 V Operation
- Gain: 15 dB Typical
- Noise Figure: 2 dB
- Adjustable Bias Using External Resistors
- RoHS Compliant

Applications

- DOCSIS 4.0 Amplifiers
- DOCSIS 4.0 Optical Nodes
- DOCSIS 4.0 Remote PHY Devices
- FTTH GPON and GEPON
- DOCSIS 4.0 Cable Modem and Home Gateways
- Single Ended Gain Block

Ordering Information

Part Number	Description
QPL1818EVB-01	Evaluation Board
QPL1818SB	Sample bag with 5 pieces
QPL1818SR	7" Reel with 100 pieces
QPL1818TR13	13" Reel with 2500 pieces

Absolute Maximum Ratings

Parameter	Rating
Supply Voltage (V_{DD})	+10 V
Supply Current (I_{DD})	140 mA
Maximum Input Level	+10 dBm
Operating Temperature Range	-40 to +100 °C
Storage Temperature Range	-65 to +150 °C
Maximum Junction Temperature	+150 °C

Exceeding any one or a combination of the Absolute Maximum Rating conditions may cause permanent damage to the device. Extended application of Absolute Maximum Rating conditions to the device may reduce device reliability.

Electrical Specifications at +5 V

Parameter	Condition ⁽¹⁾	Min	Typ	Max	Unit
Supply Voltage (V_{DD})			5		V
Supply Current (I_{DD})			100		mA
Frequency Range		50		1800	MHz
Gain			15		dB
Gain Slope			1		dB
Reverse Isolation			19		dB
Input Return Loss			20		dB
Output Return Loss			18		dB
MER	At +56dBmV Total Composite Output power. 108MHz to 1791MHz, 0dB tilt, 288Ch, QAM256		42		dB
Noise Figure			2		dB
OIP2L	+5 dBm / tone output		59		dBm
OIP2U	+5 dBm / tone output		45		dBm
OIP3	+5 dBm / tone output		37		dBm
OP1dB			19		dBm
Thermal Resistance	Θ_{JC}		60		°C/W

Note: Typical performance at these conditions: Temp = +25 °C, V_{DD} = +5 V, 75 Ω system, Full band unless otherwise noted

Evaluation Board Schematic 50 MHz – 1800 MHz

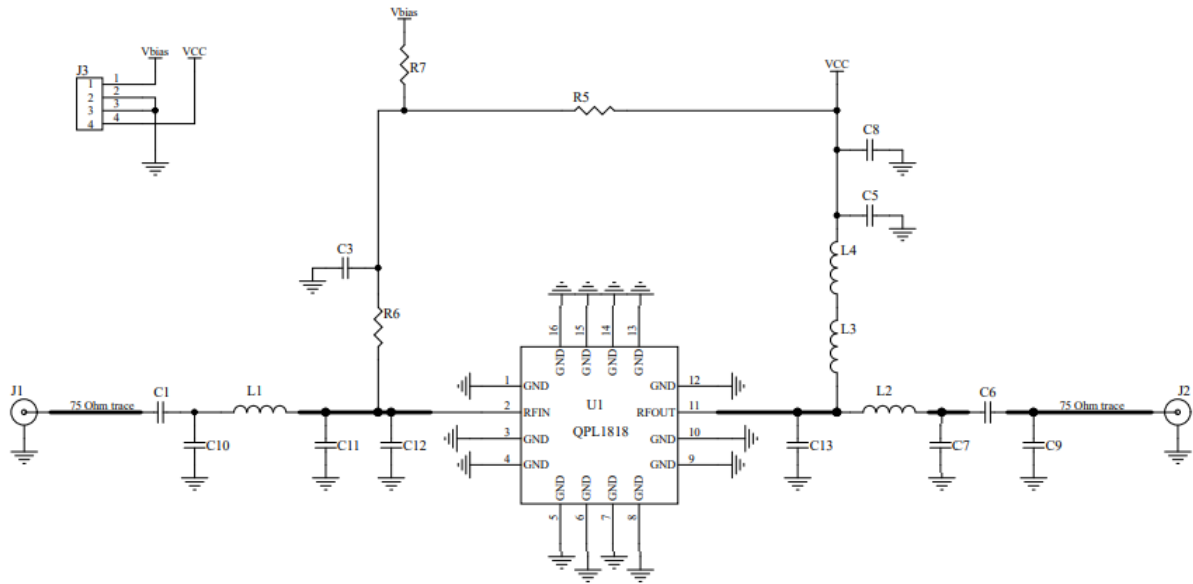

Evaluation Board Bill of Materials

Ref Des	Description	Manufacturer	Part Number
U1	1791MHz, Low Noise, High Linearity Amp	Qorvo	QPL1818
PCB	EVB PCB, QPL1818	Qorvo	SAP 296405
C1, C6	CAP, 270 pF, 5%, 0402	Murata	GCM1555C1H271JA16D
C8	CAP, 0.01uF, 10%, 0402	Murata	GCM155R71H103KA55D
L4	RES, 0 Ω, 0603	VISHAY AMERICAS INC	MCT06030Z0000ZP500
L1	IND, 2.6nH, +/-0.1nH, W/W, HI-Q, 0402	Murata	LQW15AN2N6B8ZD
L2	IND, 4.4nH, ±0.1nH, W/W, HI-Q, 0402	Murata	LQW15AN4N4G80
C9	CAP, 0.5pF, +/-0.25pF, 50V, HI-Q	Murata	GJM1555C1HR50CB01D
C11	RES, 27 K OHM,5%,1/16W,0402, LEAD FREE	KOA Speer	RK73B1ETTP273J
C12	RES, 1M, 5%, 1/16W, 0402	Kamaya, Inc	RMC1/16S-105JTH
L3	IND, 2200nH, +/-20%, 500mA, 400MHz, 0603	Taiyo Yuden	BRL1608T2R2M
J1, J2	CONN, F FEM, 75 OHMS	Millimeter Wave	MW-846-C-DD-75
J3	CONN, HDR, ST, 4-PIN, 0.100"	Samtec	TSW-103-07-G-S
R1, R5, R6, R7, C10	DNI		

Evaluation Board Assembly Drawing

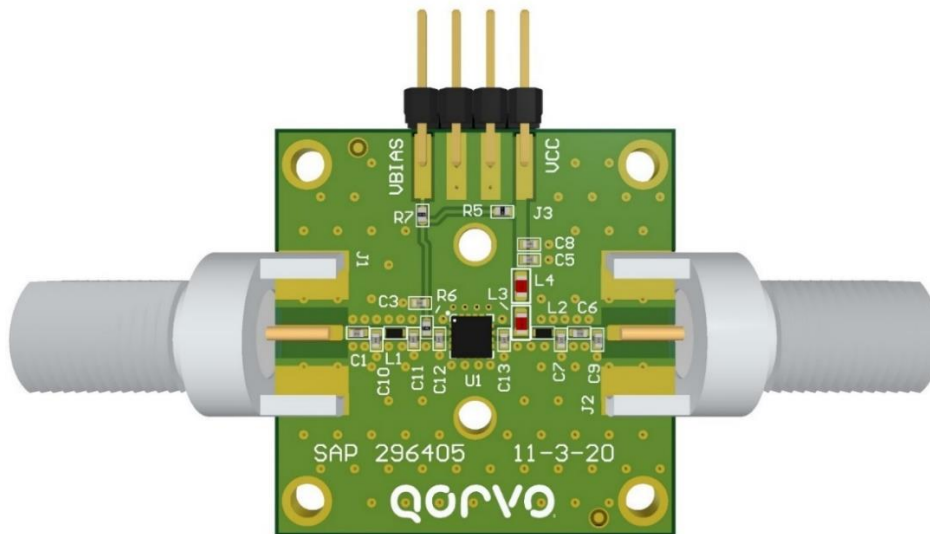
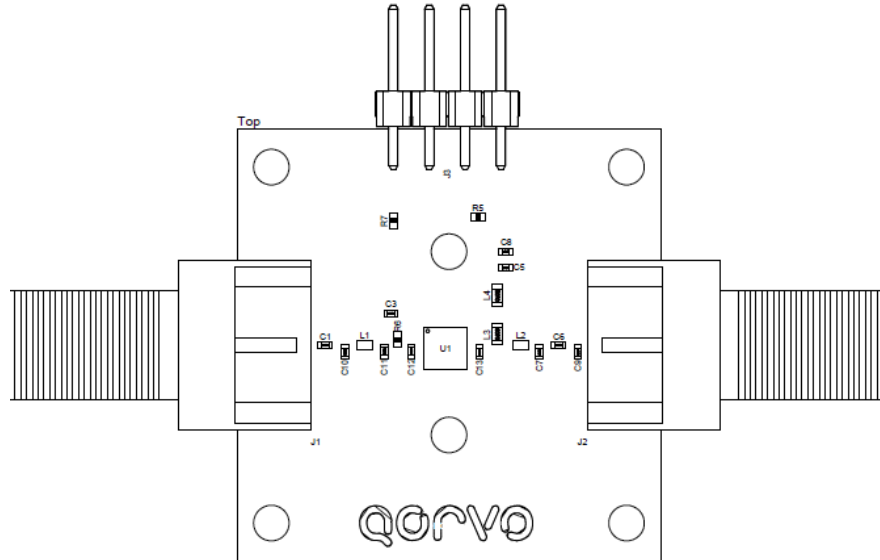

QPL1818 Evaluation Board

LAYER STACK LEGEND

Material	Layer	Thickness	Dielectric Material
	Top Overlay		
	Surface Material	0.0010in	SM-001
	CF-004	0.0007in	
	Core	0.0580in	FR-4
	CF-004	0.0007in	
Total thickness: 0.0604			

Performance Data at +5 V

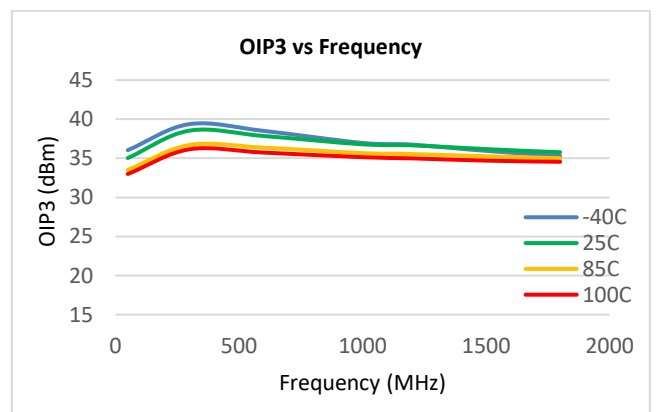
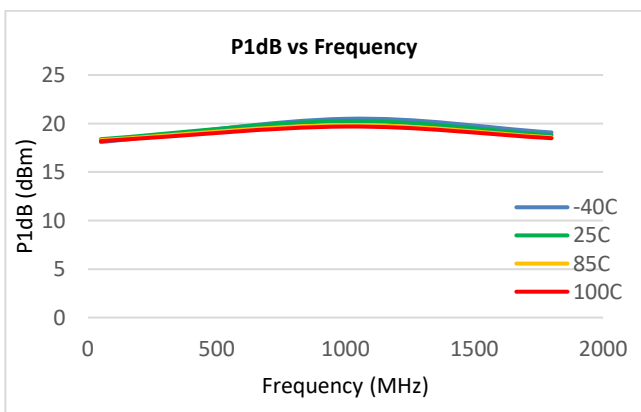
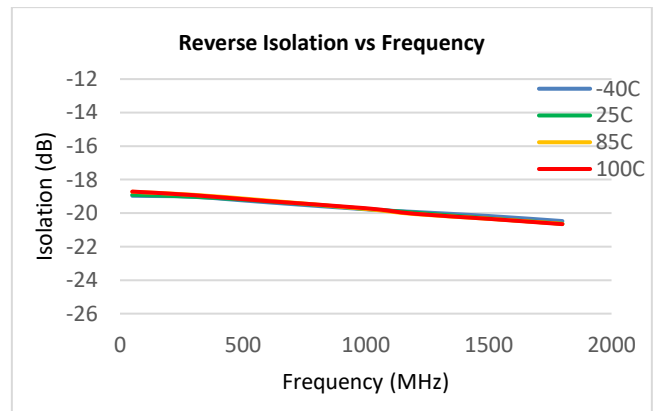
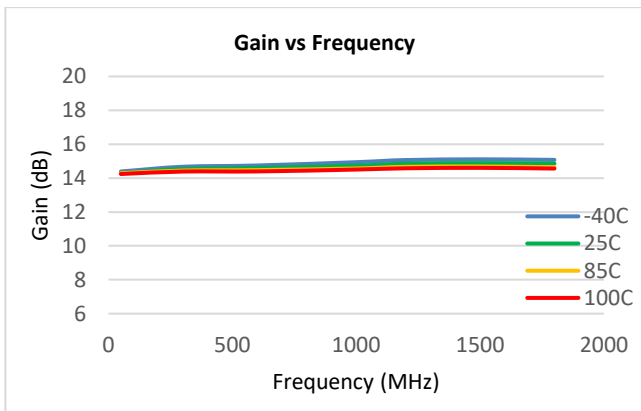
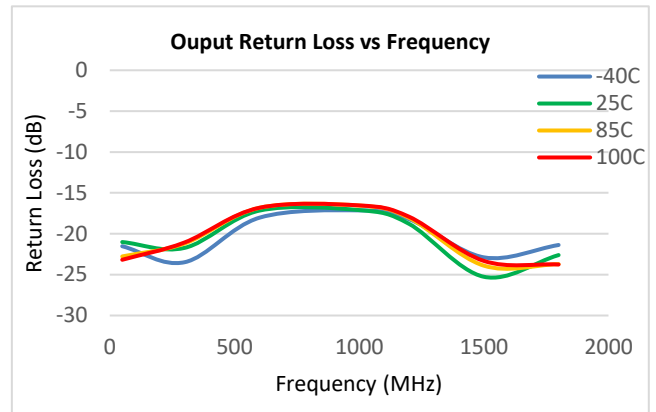
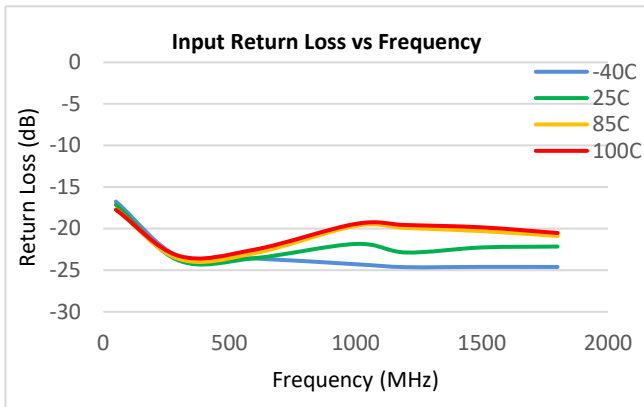

Notes: (1) OIP3: +5 dBm/tone output

Performance Data at +5 V

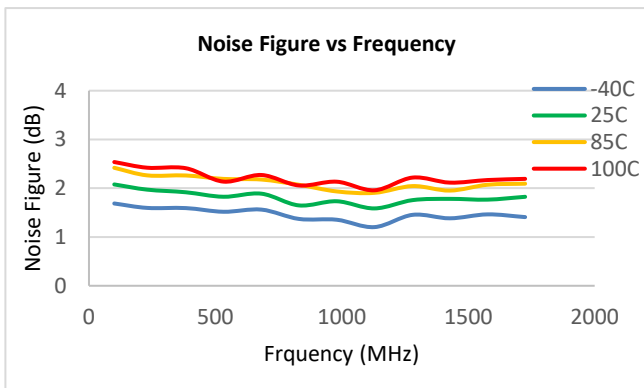
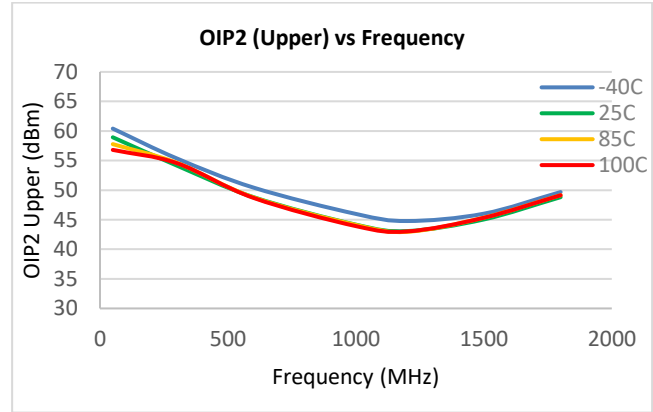
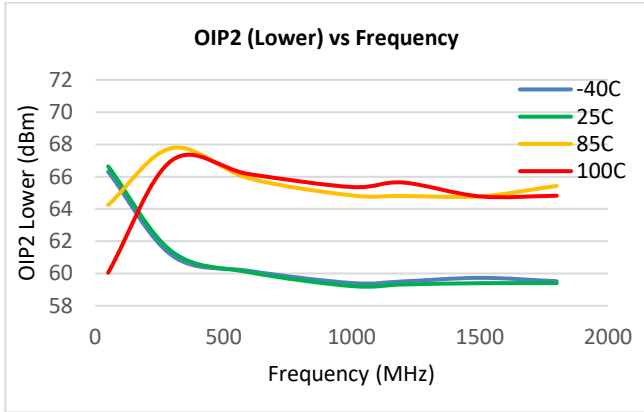

Notes:
 (1) OIP2: +5 dBm / tone output

Performance Data vs Supply Voltage

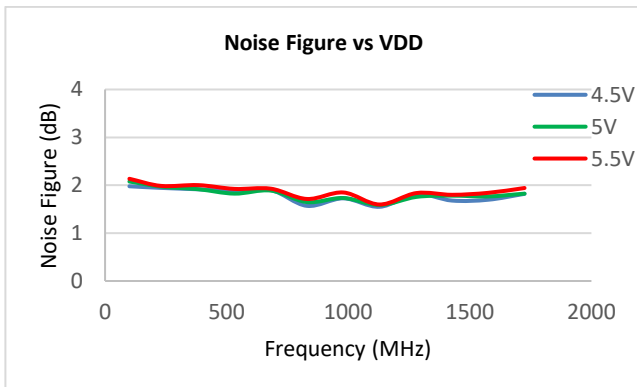
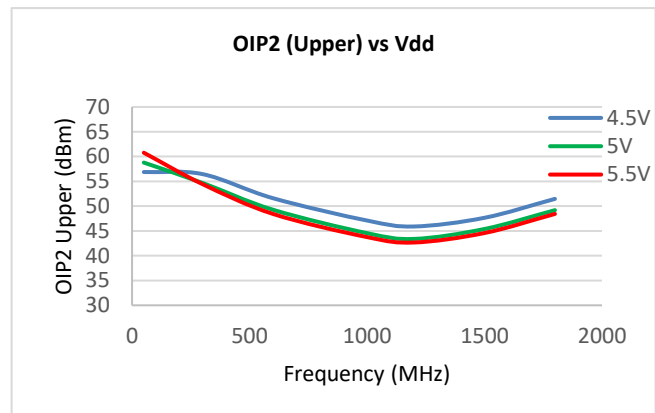
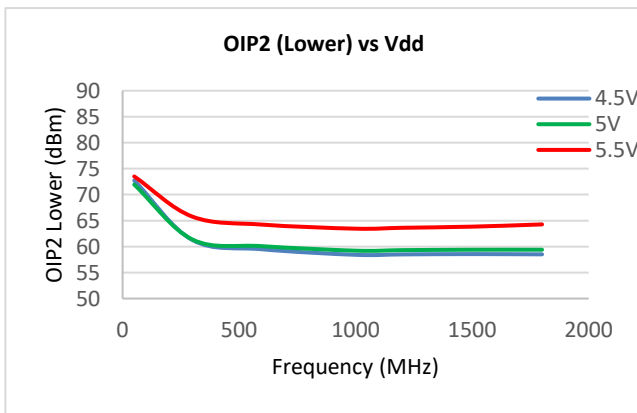
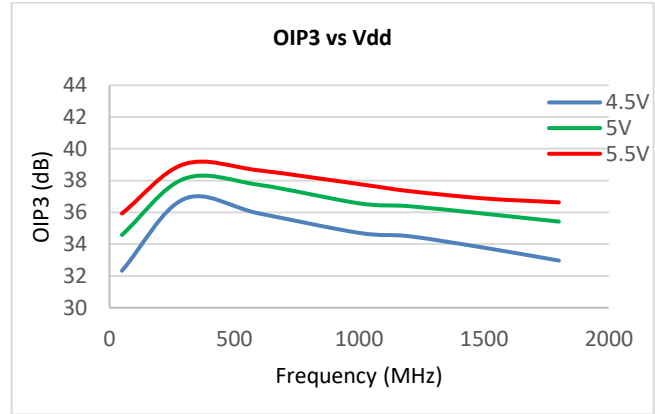
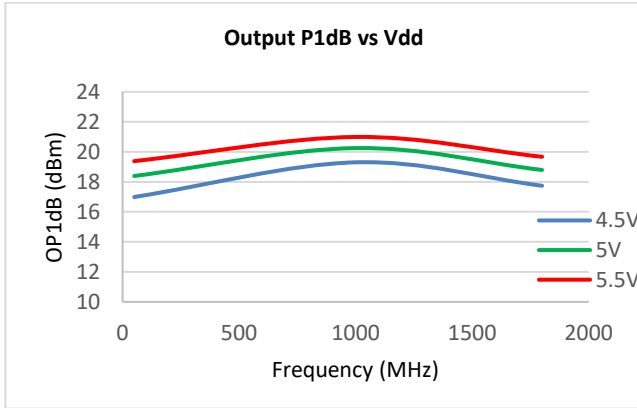

- Notes:
- (1) OIP3: 5 dBm/ tone output
 - (2) OIP2: 5 dBm/ tone output

Pin Configuration and Description

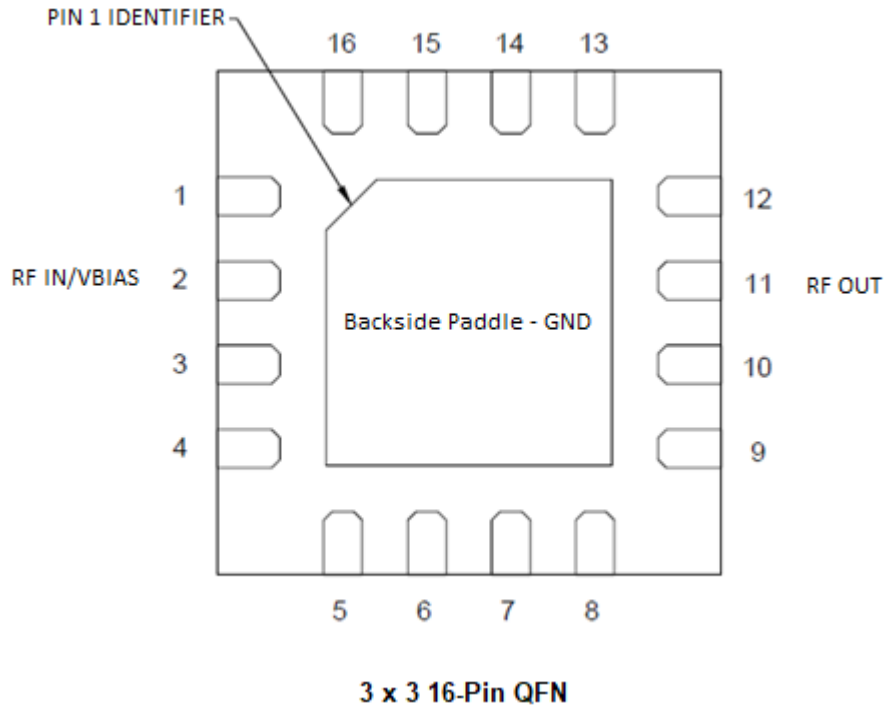

Pin Number	Label	Description
1	GND	
2	RF IN / VBIAS	RF Input, DC blocking capacitor required
3	GND	
4	GND	
5	GND	
6	GND	
7	GND	
8	GND	
9	GND	
10	GND	
11	RF OUT	RF Output
12	GND	
13	GND	
14	GND	
15	GND	
16	GND	
Backside Paddle	GND	RF/DC/Thermal/Ground. Minimize the inductance and thermal resistance.

Package Outline

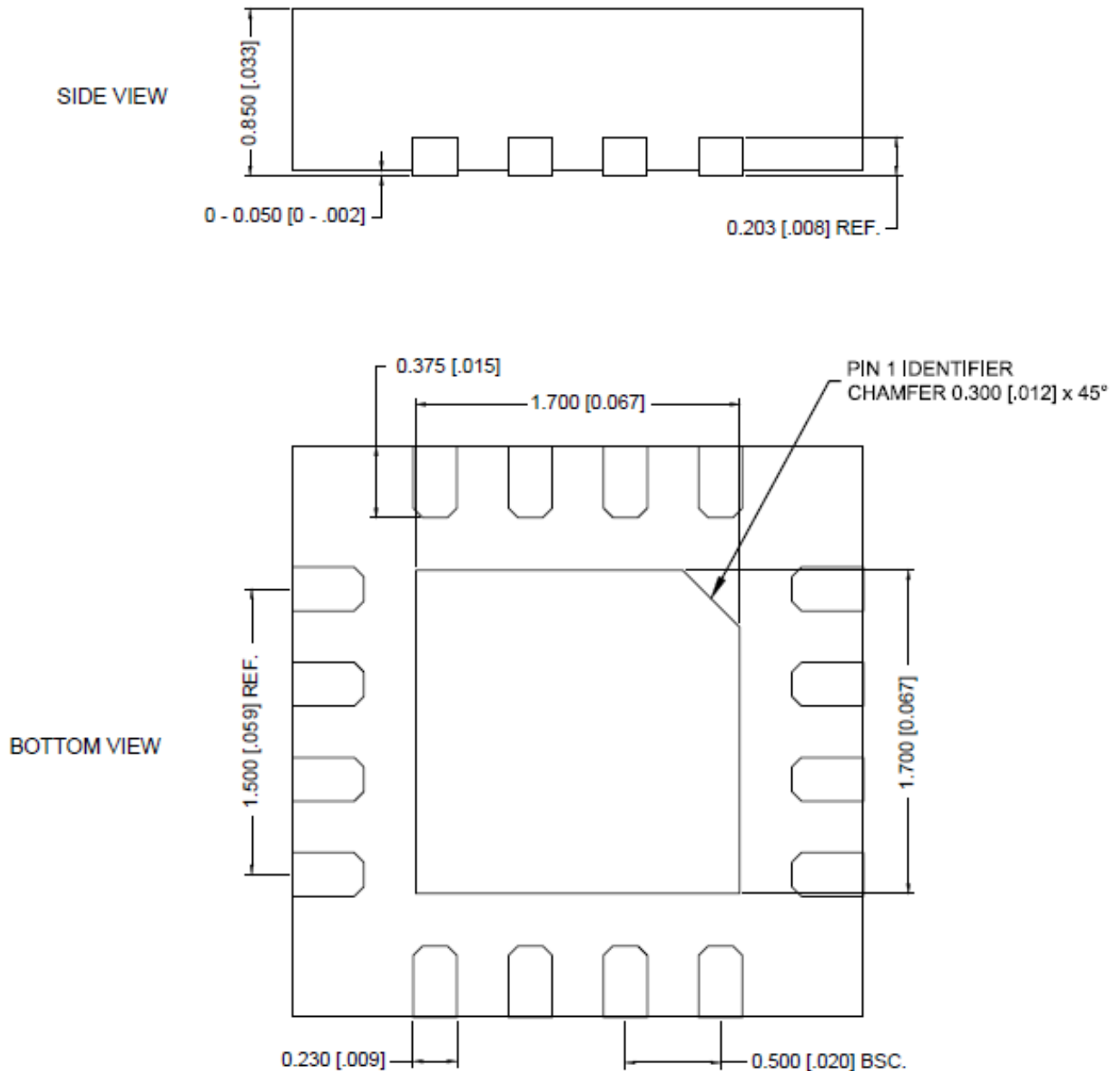

3 x 3 16-pin QFN

- Notes:
1. Dimensions in millimeters

Package Marking

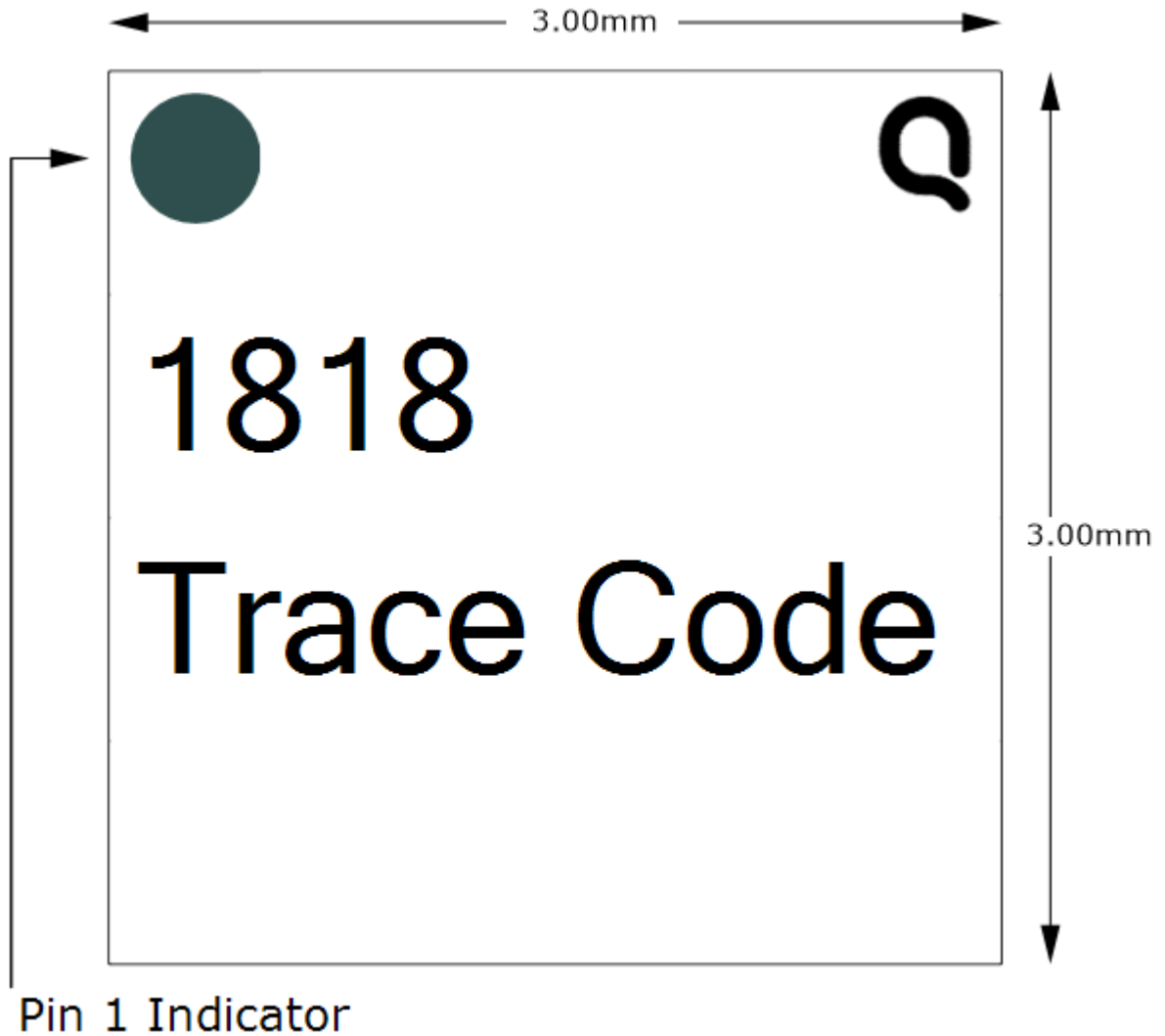

Handling Precautions

Parameter	Rating	Standard
ESD – Human Body Model (HBM)	500V, 1B	ANSI / ESDA / JEDEC JS-001
ESD – Charged Device Model (CDM)	2000V, C3	ANSI / ESDA / JEDEC JS-002
MSL – Moisture Sensitivity Level	MSL 2	IPC / JEDEC J-STD-020



Caution!
ESD-Sensitive Device

Solderability

Compatible with both lead-free (260 °C max. reflow temp.) and tin /lead (245 °C max. reflow temp.) soldering processes. Solder profiles available upon request.

Contact plating: NiPdAu

RoHS Compliance

This part is compliant with 2011/65/EU RoHS directive (Restrictions on the Use of Certain Hazardous Substances in Electrical and Electronic Equipment) as amended by Directive 2015/863/EU.

This product also has the following attributes:

- Lead Free
- PFOS Free
- Halogen Free (Chlorine, Bromine)
- Antimony Free
- TBBP-A (C₁₅H₁₂Br₄O₂) Free
- SVHC Free



Contact Information

For the latest specifications, additional product information, worldwide sales and distribution locations:

Tel: 1-844-890-8163

Web: www.qorvo.com

Email: customer.support@qorvo.com

Important Notice

The information contained herein is believed to be reliable; however, Qorvo makes no warranties regarding the information contained herein and assumes no responsibility or liability whatsoever for the use of the information contained herein. All information contained herein is subject to change without notice. Customers should obtain and verify the latest relevant information before placing orders for Qorvo products. The information contained herein or any use of such information does not grant, explicitly or implicitly, to any party any patent rights, licenses, or any other intellectual property rights, whether with regard to such information itself or anything described by such information. **THIS INFORMATION DOES NOT CONSTITUTE A WARRANTY WITH RESPECT TO THE PRODUCTS DESCRIBED HEREIN, AND QORVO HEREBY DISCLAIMS ANY AND ALL WARRANTIES WITH RESPECT TO SUCH PRODUCTS WHETHER EXPRESS OR IMPLIED BY LAW, COURSE OF DEALING, COURSE OF PERFORMANCE, USAGE OF TRADE OR OTHERWISE, INCLUDING THE IMPLIED WARRANTIES OF MERCHANTABILITY AND FITNESS FOR A PARTICULAR PURPOSE.**

Without limiting the generality of the foregoing, Qorvo products are not warranted or authorized for use as critical components in medical, life-saving, or life-sustaining applications, or other applications where a failure would reasonably be expected to cause severe personal injury or death.

Copyright 2019 © Qorvo, Inc. | Qorvo is a registered trademark of Qorvo, Inc.